

Akiles VersaMac Heavy Duty Interchangeable Die Binding Punch

Instruction Manual



Provided by

MyBinding.com
When Image Matters.

Call Us at 1-800-944-4573

TABLE OF CONTENTS

Introduction	Page 1
Features	Page 1
Assembly & Safety Instructions	Page 2
Maintenance Accessories	Page 2
Punch Patterns	Page 3
Installation of Punch Die	Page 4
Adjusting the Depth Margin Positions	Page 4
Disengagement (Removal) of Punch Pins	Page 5
Punching	Page 6
In Case of Paper Jam	Page 7
Changing Punch Die	Page 8-9
Punch Die Maintenance	Page 9
Comb Binding Module (Optional)	Page 10
Coil Binding Module (Optional)	Page 11
Wire Binding Module (Optional)	Page 12
Troubleshooting	Page 13
Warranty Policy	Page 14

TROUBLESHOOTING

Machine is switched on, but it won't work at all.

PROBLEM	ACTION
The Power Indicator Light in Manual Control Panel is not ON.	Plug in the power cord properly, and make sure Power Switch is turned ON.
Circuit breaker tripped due to the different electrical voltage used than the one specified on VersaMac label.	Plug the power cord into an outlet with the correct voltage, and press Circuit Breaker Reset Switch to reset it.
The Die-In Indicator Light in Manual Control Panel is not ON.	Make sure the punch die is FULLY INSERTED and the clamp is in LOCKED position.
Top Cover is open and the safety sensor has been activated.	Make sure that the Top Cover is closed to deactivate the safety sensor.
Manual Reverse Driver is inserted into the machine and safety sensor has been activated.	Remove the Manual Reverse Driver from the machine to deactivate the safety sensor.
Foot pedal has been pressed but machine does not work.	Make sure Foot Pedal cord is properly plugged into the machine.

Paper Jam

PROBLEM	ACTION
Punch action stopped before the cycle ended.	Follow instructions on Page 7 to clear up the paper jam. Then insert less sheets to start punching again.
Punch Die not properly installed in VersaMac.	Make sure both sides of the Pin Retainer Cover are securely locked in place, and that the punch die is fully inserted into the machine with the clamp locked.
Punching action becomes more noisy than normal and punch pins lack lubrication	Follow instructions on Page 9 to perform Punch Die Maintenance and lubricate all the punch pins.
Waste Drawer is overfilled.	Empty the Waste Drawer.

WIRE BINDING MODULE (OPTIONAL)

AKILES WBM650 Wire Closer (Available soon)

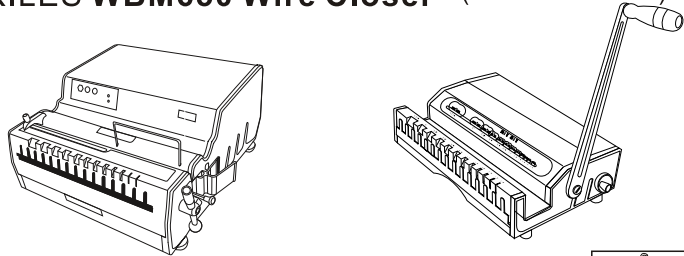

1. Place the pre-selected wire onto Wire Holder. **See Picture 1**
2. Insert document sheets into the wire, starting from the last page and continue to the first page. Then, insert the front cover. Lastly, insert the back cover with its inside facing up. **See Picture 2**
3. Lift up and remove the wire (and the sheets) from Wire Holder. Be careful not to allow the sheets to slide out of the unbound wire. **See Picture 3**
4. Turn the wire (and the sheets) upside down and carefully place the wire evenly in the Wire Closer. The wire element must stand horizontally at the bottom of Wire Closer. **See Picture 4**
5. Slowly pull the Wire Closer Handle towards you to close the wire. **See Picture 5**
6. Take out the wire bound document and turn the back cover over to hide the closure seam inside the last page of your book. The wire binding is now complete. **See Picture 6**

TIPS

The seam of a closed wire should be hidden inside the book (in between the last page and back cover). Follow Step 2 in the instructions above for best results.

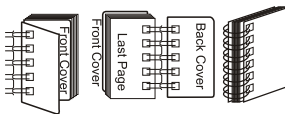

The seam of a well closed wire should have the narrow loop just touching the wide loop. If this is not the case on your first try, slightly adjust the Wire Closer Control towards the LEFT (for the under-closed wire) or the RIGHT (for the over-closed wire), so the next wire you close would have a perfect closure seam.

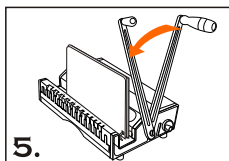
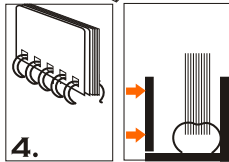
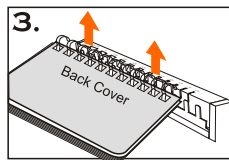
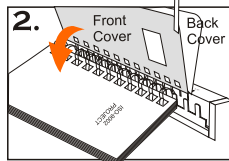
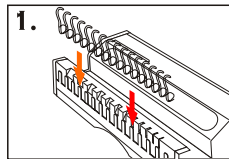
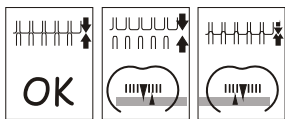

INTRODUCTION

Congratulations on the purchase of your new **VERSAMAC**, a professional and heavy-duty punching machine. Your **VERSAMAC** was designed with a full range of functions & safety features, along with premium quality components to guarantee an effortless and pleasant book binding experience, as well as many years of trouble-free service.

IMPORTANT

We recommend that you take a moment to familiarize yourself with the functions of your new **VERSAMAC**. Make sure you read all the features and safety instructions, and follow these guidelines to install, operate and maintain your **VERSAMAC**. You will find that with just a little practice, any person can achieve professional results.

FEATURES

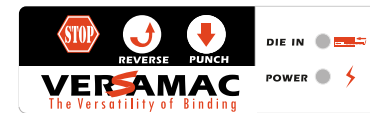

Manual Control Panel

- Manual Punch Switch
- Reverse (Anti-Jam) Switch
- Emergency Stop Switch
- Power & Die-in Indicator

Circuit Breaker
Reset Switch

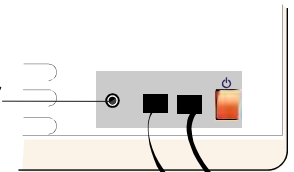

Alignment Channel
(for Coil Binding)

Side Margin
Control

Punch Ruler Guide
Diameter Scale

Wire Holder

Foot Pedal
Control

Power Switch
Power Cord Socket
Foot Pedal Socket

Paper Holder
Punch Throat
(open ended)
Interchangeable Die

Depth Margin Control

Die-Lock Clamp

Waste Drawer

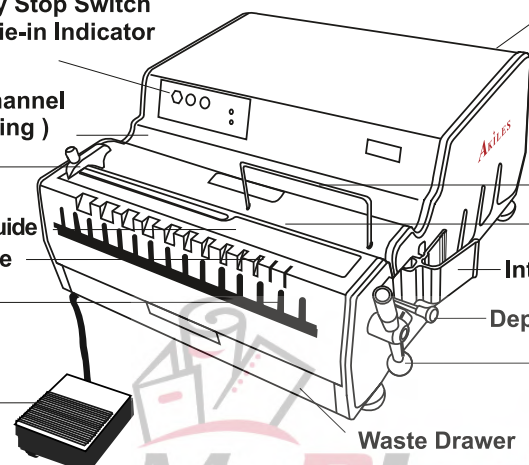

ASSEMBLY & SAFETY INSTRUCTIONS

1. Place your new **VERSAMAC** on top of a sturdy work table by at least 2 persons. **The machine weighs over 100 lbs and cannot be lifted by yourself!** It should be lifted from all 4 corners by at least 2 persons. **See Picture 1**
2. Plug the POWER CORD and FOOT PEDAL CORD into the back of the machine. **See Picture 2**
3. If necessary, adjust the height of legs of your **VERSAMAC** so that it stands firmly and evenly. **See Picture 3**
4. Place the FOOT PEDAL on the floor in front of the machine. **See Picture 4**

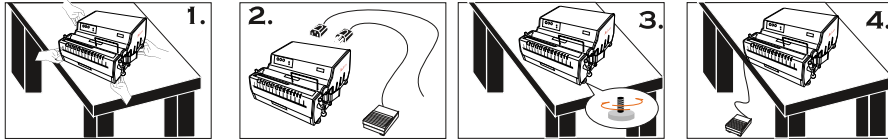

5. Plug the other end of POWER CORD into an outlet with the correct voltage and type. Powering the machine with incorrect voltage may severely damage its electrical components and result in personal injury!
6. **IMPORTANT:** Always turn Main Power Switch OFF and place Foot Pedal out of reach before setting up, performing maintenance, or changing dies on the **VERSAMAC**.
7. To reduce the risk of electrical shock, never operate the **VERSAMAC** near water.
8. Do not use **VERSAMAC** if the Power Cord or Foot Pedal Cord is damaged.
9. Do not allow the electric cords to be in contact with hot surfaces.
10. In case of malfunction, return the machine to your dealer for service. This equipment does not contain any part that can be serviced by the operator.

MAINTENANCE ACCESSORIES

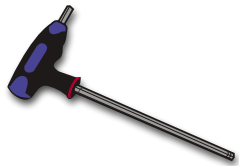

Manual Reverse Driver



Cleaning Brush



Anti-Rust Lubricant

COIL BINDING MODULE (OPTIONAL)

AKILES Roll@Coil Electric Coil Inserter

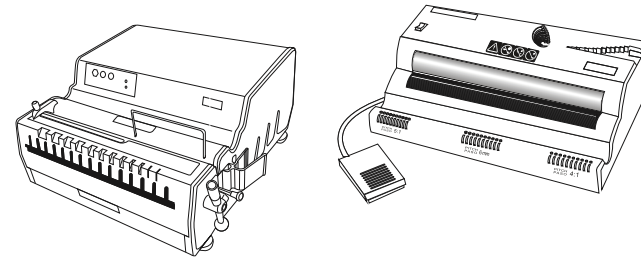

1. Align all the holes of your pre-punched sheets, then gently jog it in the U-Shaped Alignment Channel located in the front of Roll@Coil. This channel aids in conforming the spine of larger document to the coil shape, for a faster and easier coil insertion. **See Picture 1**

REMARKS: The same U-Shaped Alignment Channel can also be found in your VersaMac.

2. While holding the sheets in place with one hand, use your other hand to start inserting the coil into the first 5 holes. **See Picture 2**
3. Step on the Foot Pedal to activate the Coil Inserting Roller. Move the document SLOWLY and EVENLY towards the moving roller, until coil starts to move forward into the holes. **See Picture 3**

4. Immediately after the last hole insertion, move the document away from the roller and/or release the Foot Pedal.
- REMARKS:** If coil has been inserted past your desired position, simply flip the document over and follow the instructions on Step 3 above again.

5. Use coil crimpers to cut & crimp the extra coil from both sides of your document. This procedure will also prevent the document from unbinding itself in the future. **See Picture 4**

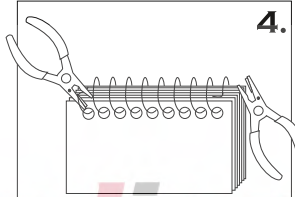
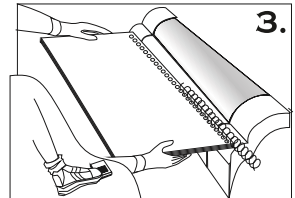
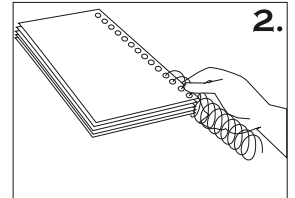
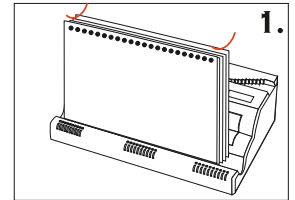

COMB BINDING MODULE (OPTIONAL)

AKILES CBM650 Comb Opener

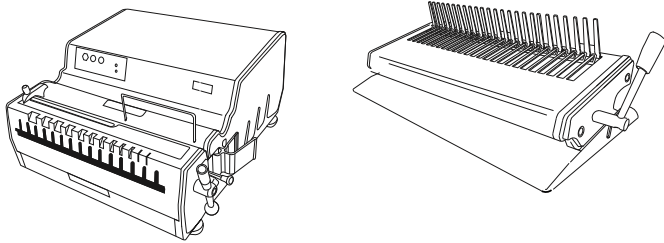

1. Place pre-selected comb behind Comb Binding Fingers. The opening side of comb should be on top. **See Picture 1**

2. Slowly pull Comb Opener Handle down to open the comb, and stop when the comb is opened enough to allow sheets to be inserted. **See Picture 2**

IMPORTANT: Depending on the size of the comb used, it may not be necessary to pull the Comb Opener Handle all the way down.

3. Jog the sheets and covers so all the holes are well aligned. Holding the document tightly with the front cover facing you, insert it into the open comb. **See Picture 3**

4. When all pages have been inserted into the open comb, slowly return the Comb Opener Handle to close the comb. Lift the entire book upwards to take it out of Comb Binding Fingers. The comb binding is now complete. **See Picture 4**

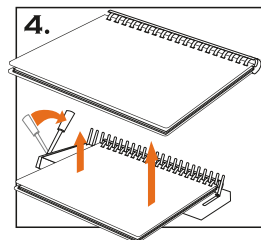
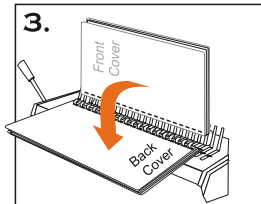
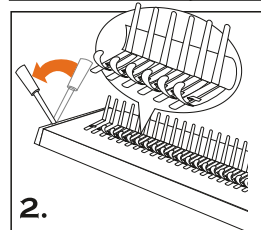
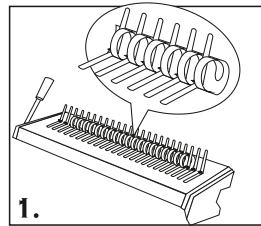

PUNCH PATTERNS

Standard Punch Patterns :

COIL 4:1 (OVAL)

OVAL 4:1
Pitch: 0.2475" 4x5 mm
Adjustable margin: 2mm, 3mm, 4mm or 5mm

COIL 4:1 (ROUND)

Coil 4:1
Pitch: 1/4" Ø 4 mm
Adjustable margin: 2mm, 3mm, 4mm or 5mm

WIRE 3:1 (SQUARE)

Wire 3:1
Pitch: 1/3" 4 x 4 mm
Adjustable margin: 2mm, 3mm, 4mm or 5mm

WIRE 3:1 (With thumb cut for calendar)

Wire 3:1
Pitch: 1/3" 4 x 4 mm
Adjustable margin: 2mm, 3mm, 4mm or 5mm

WIRE 2:1 (RECTANGULAR)

Wire 2:1
Pitch: 1/2" 4 x 5.5 mm
Adjustable margin: 2mm, 3mm, 4mm or 5mm

COMB (RECTANGULAR)

Comb
Pitch: 9/16" 8 x 3 mm
Adjustable margin: 2mm, 3mm, 4mm or 5mm

3 HOLE (ROUND)

3 HOLE
Pitch: 4-1/4" Ø5/16"
Fixed margin at 1/4"

Other Available Punch Patterns :

COIL 6MM (ROUND)

Coil 6mm
Pitch: 6mm Ø 4 mm
Adjustable margin: 2mm, 3mm, 4mm or 5mm

COIL 6MM (OVAL)

Oval 6mm
Pitch: 6mm 4x5 mm
Adjustable margin: 2mm, 3mm, 4mm or 5mm

COIL 5MM (ROUND)

Coil 5mm
Pitch: 6mm Ø3.6mm
Adjustable margin: 2mm, 3mm, 4mm or 5mm

WIRE 3:1 (ROUND)

Wire 3:1
Pitch: 1/3" Ø4.5mm
Adjustable margin: 2mm, 3mm, 4mm or 5mm

WIRE 3:1 (With thumb cut for calendar)

Wire 3:1
Pitch: 1/3" Ø4.5mm
Adjustable margin: 2mm, 3mm, 4mm or 5mm

WIRE 2:1 (ROUND)

Wire 2:1
Pitch: 1/2" Ø 6 mm
Adjustable margin: 2mm, 3mm, 4mm or 5mm

VELO (ROUND)

VELO
Pitch: 1" Ø1/8"
Fixed margin at 1/16"

REMARK:

1. Pitch: Distance from center of a hole to center of another hole.
2. Margin: Distance from edge of paper to the nearest edge of the hole.
3. More special punch patterns may be available. Contact your dealer for more updated pattern list or to see if your custom punch pattern can be manufactured.

INSTALLATION OF PUNCH DIE

Main Power must be switched OFF before punch die installation begins.

1. From the right-hand side of the machine, insert the punch die into the Die Set Channel. **See Picture 1**
2. Slide the punch die all the way in. **See Picture 2**
3. Turn the Die Locking Clamp **clockwise** to securely lock the punch die in place. **See Picture 2 & 3**
4. Turn the Main Power Switch ON. The indicator light for "Die In" will turn green.
5. Make appropriate adjustment to select the Depth Margin position best suited for your job. There are 4 available depth margin positions in each punch die (2mm, 3mm, 4mm and 5mm from edge of paper to the nearest edge of hole). Adjustments of such can be done by PULLING or PUSHING the Depth Margin Control Bar towards the LEFT or RIGHT side of the machine. **See Picture 4**

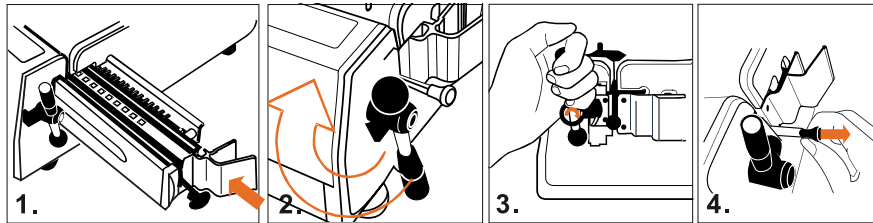

TIPS

The exact position of Depth Margin is based on the book thickness and operator's preference. However, as a rule of thumb, an ideal Depth Margin setting should allow easy turning of the pages while providing enough tear resistance to the sheet.

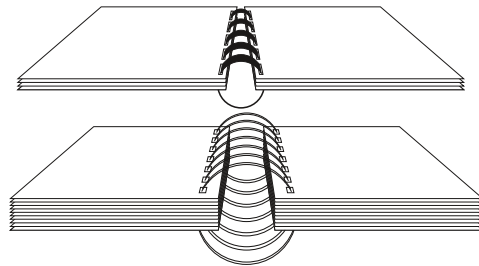

Remark:

1. No Depth Margin adjustment is available on Velo & 3 Hole punch patterns.
2. Never pull or push the Depth Margin Control Bar UPWARD or DOWNWARD. Doing so may damage the Depth Margin Control mechanism in your punch die.

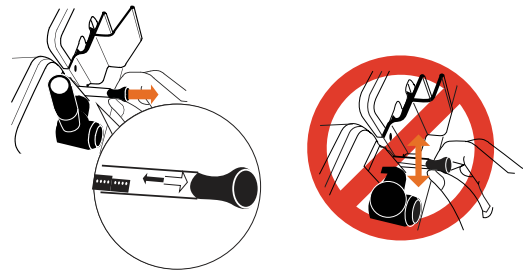

3. Use the included Cleaning Brush to remove any paper debris out of Punch Throat and other opening areas in your **VERSAMAC**.
4. Install a different Punch Die into the machine by following the instructions on Page 4 of this Operational Manual.

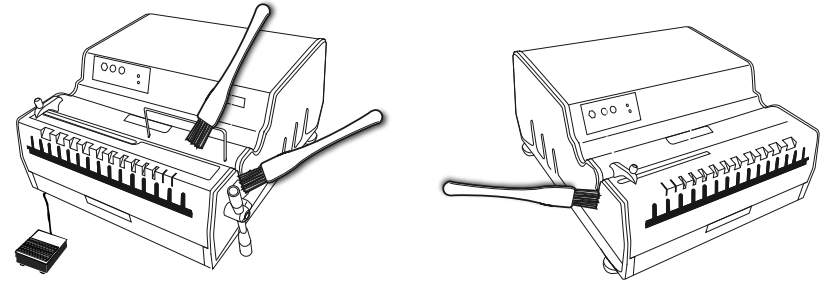

PUNCH DIE MAINTENANCE

To keep your **VERSAMAC** running in the optimal condition at all times, Punch Die Maintenance should be performed on a regular basis. To do so, simply remove the punch die from machine following instructions on Page 8. Then carefully apply the anti-rust lubricant (included accessory item) onto all the punch pins in the die set. Re-install the punch die into the machine and remove excessive lubricant by punching some scratch paper.

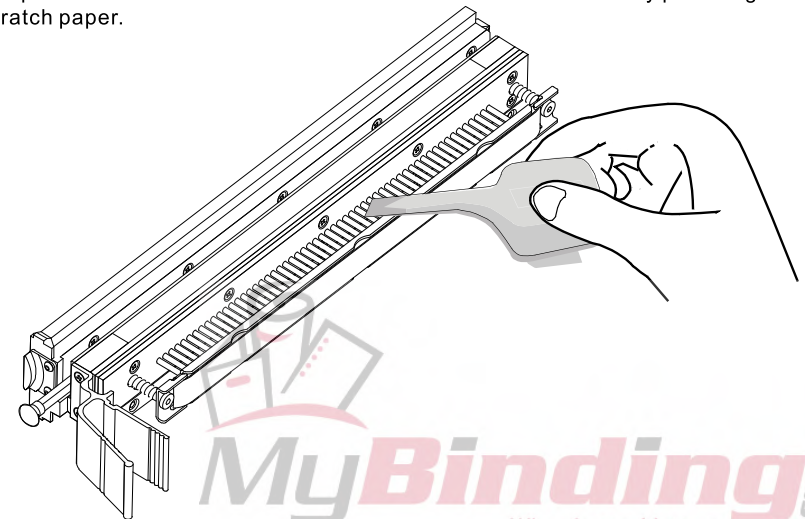

CHANGING PUNCH DIE

IMPORTANT:

Always shut off power when changing Punch Die. Do NOT turn on power before the Punch Die is fully inserted and the clamp is in the LOCKED position.

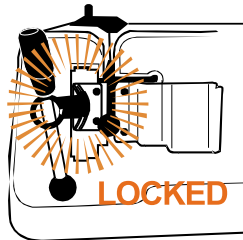
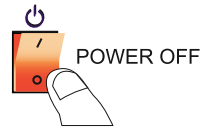

By following the simple steps below, you can quickly and easily change the punch die of your **VERSAMAC** within seconds:

1. Lift up the lever of the Die-lock Clamp and turn it counterclockwise to unlock the Punch Die. During the turn, also make sure that the lever does not hit the Depth Margin Adjustment bar.
2. Gently pull on the Punch Die Handle to slide the existing Punch Die out of your **VERSAMAC**. When the Punch Die is about half way out, use **both hands** to hold the die and remove it completely. (Each Punch Die weighs over 10 Lbs and is too heavy to be handled by just one hand)

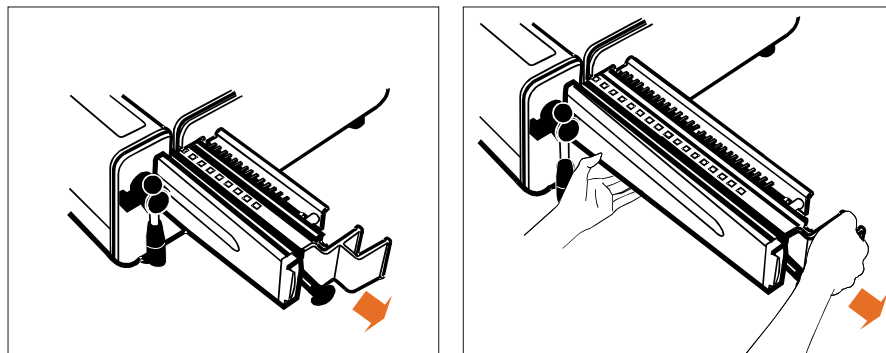
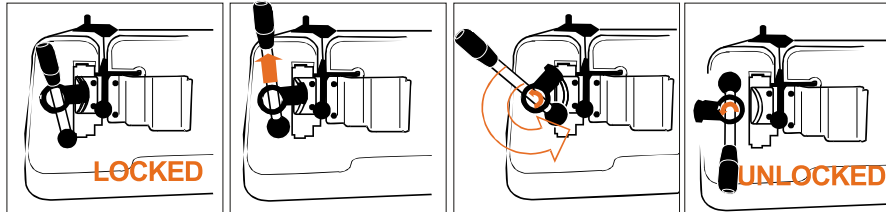

DISENGAGEMENT (REMOVAL) OF PUNCH PINS

To avoid partially punched holes, follow the simple steps below to disengage (remove) the corresponding punch pin in the die set.

For most standard sheet sizes, you can easily find the holes that need to be disengaged (removed) from the Punch Ruler Guide. Just look for the sheet size that you are using, and identify the appropriate punch pin that will create a partial punched hole in your sheet. **See examples below**

Partially punched hole on a 11" sheet

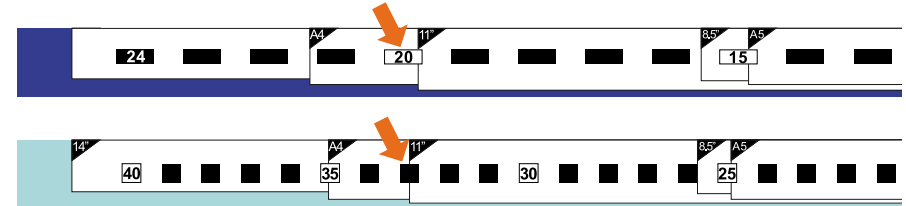

1. Open the punch pin retainer cover by pulling it upward to unlock one side first, then the other side.

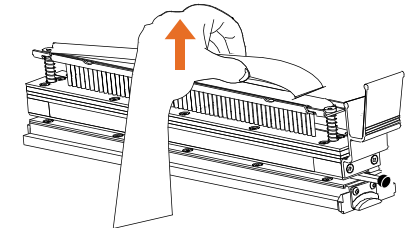

2. Remove the desired punch pin from the die set.

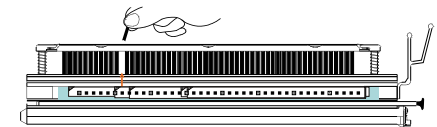

3. Re-Install the punch pin retainer cover onto the die set. Make sure both sides of the retainer cover are securely locked in place.

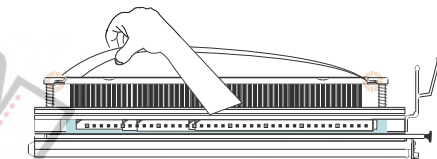

PUNCHING

IMPORTANT:

Before operating the machine, always make sure that the **Punching Die** is **FULLY INSERTED** and the Clamp is in **LOCKED** position.

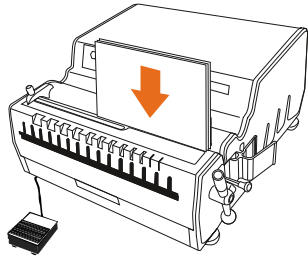
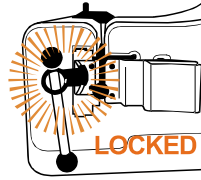

1. Turn on the POWER switch. Both LED indicator lights at Manual Control Panel should light up.



2. Align the **Side Margin Control** to the correct position according to the punch die installed and sheet (or cover) size being used.

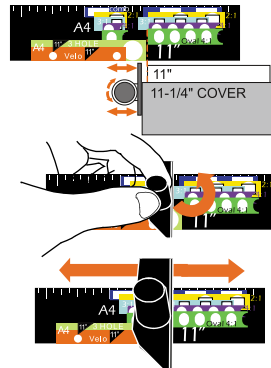

3. Insert sheets into the Punch Throat from right-hand side of the machine, then slide it towards the left until it aligns to the Side Margin Control.

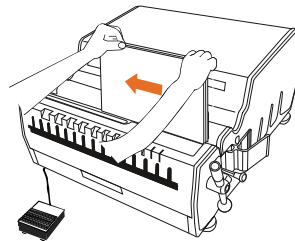

4. Activate the punching action by stepping on the Foot Pedal or by pressing the **Manual Punch Switch** on Manual Control Panel.

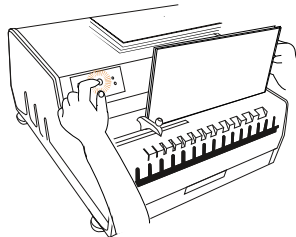

TIPS

Maximum single punch capacity ranges from 35 to 55 sheets (20 lbs paper).

The number of sheets depends on Punch Die pattern used.

For maximum equipment durability, we recommend 25 sheets (20 lbs paper) per punch.

When punching acetate or other types of heavier stock, always punch fewer sheets.

Check and empty the Waste Drawer frequently. Overfilled Waste Drawer may damage the Punch Die or the machine itself.

IN CASE OF PAPER JAM

Electric Jam Release:

Thanks to the advanced design of **VERSAMAC** electronic circuit board, the punching action will automatically stop in case of sheet overload. When this occurs, simply press the **Reverse (Anti-Jam) Switch** on the Manual Control Panel repeatedly, until the motor & punch pins are returned to the original home position. Then take out some sheets and resume your punching action again.

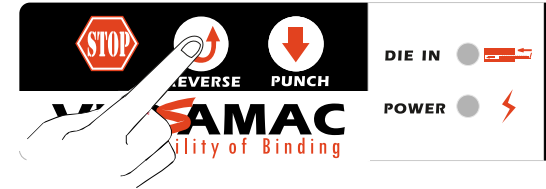

Manual Jam Release:

If for any reason the punching pins are not able to return to their original home position by pressing the Reverse (Anti-Jam) Switch, a **Manual Reverse Procedure** may be necessary to clear up the jam:

1. First, shut off the Power Switch.
2. Insert the **Manual Reverse Driver** (included accessory of VersaMac) into the hole in the left side panel of the machine.
3. If the punch action stopped **before** all the punch pins reached their bottom, fully extended position, turn the Manual Reverse Driver **counterclockwise** to pull the punch pins out of the sheet.
4. If the punch action stopped **after** all the punch pins reached their bottom, fully extended position, turn the Manual Reverse Driver **clockwise** to continue the punch pins out of the sheet.
5. Remove all sheets from the punch throat.
6. Remove Manual Reverse Driver from the machine, then turn ON the power and press the foot pedal to make sure machine operates correctly. You might also need to reset the circuit breaker by pressing the **Circuit Breaker Reset Switch** in the rear of the machine.

