

Formax FD 6204-A1 Low Volume 1 Feeder Desktop Inserter with BRE

Instruction Manual



Provided by

MyBinding.com

When Image Matters.

Call Us at 1-800-944-4573

FORMAX[®]

6204 Series Low-Volume Desktop Inserter

MyBinding.com
5500 NE Moore Court
Hillsboro, OR 97124
Toll Free: 1-800-944-4573
Local: 503-640-5920

7/2012

OPERATOR MANUAL

Table of Contents

1	Read this First	1
	Warning.....	1
	About this manual.....	1
	Safety.....	2
	Country Specific Conditions.....	4
	End of Life	5
2		
	Overview.....	6
	Operating Controls.....	8
	Control Panel.....	9
	Installing the Document Feed Trays.....	10
	Installing the Slide and Catch tray.....	11
	Power Up.....	12
	Home Menu.....	12
	Job Info.....	13
	Side Guides.....	15
	Document Orientation.....	16
	Filling the Document Feeder Tray.....	16
	Loading Envelopes.....	17
	Sealing Envelopes.....	18
	Filling the Sealing Liquid Reservoir.....	19
	Shut Down the System.....	20
3	Options	21
	Side Exit.....	21
	insert'n Frank / insert'n Mail	21
4	Processing Mail Sets	22
	Introduction.....	22
	Processing a Basic Mail Set.....	23

Processing a Mail Set with BRE or Inserts.....	24
Document Separation.....	25
Processing Daily Mail.....	25
Test Run.....	26
Adjusting the Address Position.....	26
Adjusting the Envelope Insert Fingers.....	27
Verifying the Insert Position.....	28
5 Working with Jobs	29
What is a job.....	29
Creating a new job.....	29
Performing a test run.....	31
Adjusting the Envelope Position.....	32
Using a job.....	33
Editing a job.....	34
Copying a job.....	35
Deleting a job.....	36
Job settings.....	37
Envelope settings.....	38
Document settings.....	39
Fold settings.....	41
Reading settings (option).....	43
Double feed control settings.....	44
Job name.....	45
Mailing/Frinking settings (option).....	45
6 Advanced Settings	46
What are Advanced Settings?.....	46
Opening the Advanced Settings.....	47
Changing the Display Settings.....	47
Viewing System info and Software versions.....	48
What are licensed options?.....	49
Activating an option.....	49
Test Menu.....	50

	Running diagnostics.....	51
7	Reading	52
	Introduction.....	52
	Adjusting the reading head position.....	53
	Document Orientation.....	54
	OMR Code Description.....	55
	Running an OMR test.....	58
8	Operator Maintenance	60
	Maintenance Schedule.....	60
	Clean and replace brushes.....	61
	Clean the sensors on the envelope or document path.....	61
	Clean the exit sensors.....	62
	Resetting Photocells.....	62
9	Fault Finding	63
	Error Messages.....	63
	Clearing Stoppages.....	64
	Lower Envelope Track.....	65
	FlexFeed.....	66
	Collating Area.....	66
	PowerFold.....	67
	Operator Troubleshooting.....	67
	Trouble Shooting Table.....	68
10	Specifications	72
	Technical Specifications.....	72
	Hopper and feeder capacity.....	73
	Configuration Dimensions.....	73
	Document and Insert Specifications.....	73
	Envelope and Document Set Specifications.....	75
11	Terminology	76
	Terminology.....	76
12	EC Declaration of Conformity	82
13	Index	84

MyBinding.com
5500 NE Moore Court
Hillsboro, OR 97124
Toll Free: 1-800-944-4573
Local: 503-640-5920

1 Read this First

Warning



Ensure you have read and fully understood the safety requirements in this section.

About this manual

Languages

According to the EC (European Commission) declaration following the Low Voltage Directive (2006/95/EC), this operator manual must be available in the national language(s) of the country where the system is delivered. Therefore, if you do not have an operator manual in your country's language(s), contact your authorized distributor.

Software

The software used for the reading option is based in part on the work of the Independent JPEG Group.

Audience

This manual is meant for operators of the document system.

Trademarks

™

MyBinding.com
5500 NE Moore Court
Hillsboro, OR 97124
Toll Free: 1-800-944-4573
Local: 503-640-5920

Symbols

This manual uses the symbols listed below.



WARNING : Indicates a human safety hazard.



ATTENTION : A risk to the equipment or mail could result from an action you may perform.



NOTE : A remark that explains different cases or specificities.



TIP : Advice to help save you time when processing your mail.



SUPERVISOR : Indicates that you have to use the supervisor menu to perform the procedure.

Safety

Warnings

- Disconnect the power supply before performing any maintenance.
- Before connecting the system to the electrical supply, Ensure that the system is suitable for the local mains voltage. Refer to the serial plate on your system for voltage requirements.

MyBinding.com
5500 NE Moore Court
Hillsboro, OR 97124
Toll Free: 1-800-944-4573
Local: 503-640-5920

Safety Precautions

- Only competent, trained personnel should operate this system. If non-trained personnel do operate this system, the manufacturer will not accept responsibility for any resulting accidents or injuries.
- Only skilled persons, who are aware of the risks involved, may open the protective covers.
For safety reasons, the system will not function when the covers are open.
- Keep long hair, fingers, jewelry, etc. away from rotating and moving parts.
- The power connection must be easily accessible, preferably close to the system.
For safety reasons, it is essential that the system is connected to a socket outlet that has a protective earth (ground) connection.
- Overcurrent protection in the equipment also relies on the branch circuit protection (max. 20 A).
- The following part(s) is (are) considered the equipment disconnect device(s):
 - Power supply cord plug or appliance coupler.



CAUTION: DOUBLE POLE / NEUTRAL FUSING

(this means that after operating of the fuse, parts of the equipment that remain energized, might represent a hazard during servicing.)

Precaution

The general process of automated document handling can sometimes create a build up of static electricity. Therefore we recommend that the following measures are taken to reduce the side effects of any electrostatic charge.

- Make sure that you operate the system within the recommended temperature and humidity conditions.
- Make use of antistatic mats where appropriate.
- If necessary, make use of an ionizer to reduce static charge build up in the room where the system is located.

Please contact your supplier for further information.

MyBinding.com
5500 NE Moore Court
Hillsboro, OR 97124
Toll Free: 1-800-944-4573
Local: 503-640-5920

MyBinding.com
5500 NE Moore Court
Hillsboro, OR 97124
Toll Free: 1-800-944-4573
Local: 503-640-5920

End of Life

l
ry
ge

te.
an
er

English

r
ce

MyBinding.com
5500 NE Moore Court
Hillsboro, OR 97124
Toll Free: 1-800-944-4573
Local: 503-640-5920

2 Meet your Document System

2

Overview

Introduction

The system is a folding and inserting system for processing mail easily. The system:

- Feeds documents
- Folds the documents
- Inserts the documents into envelopes
- Seals the envelopes
- Stacks the envelopes

Automatic monitoring ensures the correct number of documents per envelope. The system can be operated by means of a user friendly interface. The settings of the system (types of documents, type of envelopes and the type of fold) is recorded in so called jobs. These jobs can be programmed by an authorized user.

The system is equipped with a variety of special features, such as:

- Document thickness detection
- Programmable jobs
- Automatic jobs
- flexFeed
- Double feed control
- Hopper swap
- Multifeed
- Daily mail
- powerFold.

MyBinding.com
5500 NE Moore Court
Hillsboro, OR 97124
Toll Free: 1-800-944-4573
Local: 503-640-5920

English

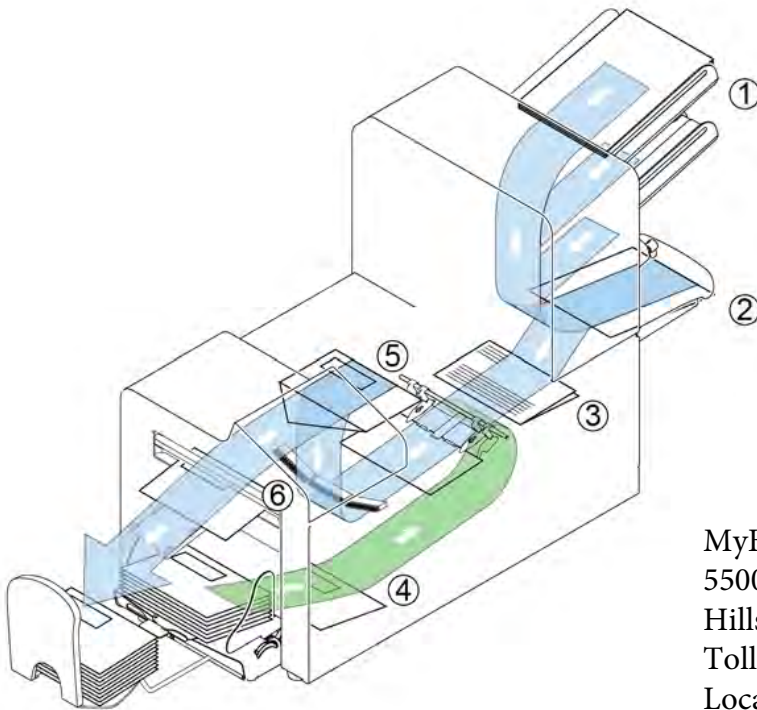

MyBinding.com
 5500 NE Moore Court
 Hillsboro, OR 97124
 Toll Free: 1-800-944-4573
 Local: 503-640-5920

The figure shows an overview of the system.

Document Feeders (flexFeed) (1)

The flexFeed is the feeding part of the system. There are two types of feeders: the automatic and the special feeder. The automatic feeder does not require any adjustments for the separation. From a feeder you can feed one or more documents (multi feed). The feeders have a double feed control (DFC). DFC detects if more documents are fed instead of one. You can link feeders. This means that two feeders can be linked as pairs. When the first feeder is empty, the system switches to the other feeder. Meanwhile the empty feeder can be refilled without stopping the system.

The upper automatic feeder is equipped with a 'daily mail' function. You can use this feeder to process sets of documents that you cannot process automatically (stapled documents and sets with varying thickness).

Collating Area (2)

All documents of a document set are collated and aligned in the collating area.

powerFold(3)

The fold unit folds the documents. The following fold types are possible (see [Terminology](#)):

- No fold
- V-fold
- C-fold
- Z-fold

- Double V-fold

Envelope feeder (4)

Envelopes that are placed on a stack by the user, are fed one by one into the system by the envelope feeder.

Inserter (5)

After the documents are folded, the documents are transported to the inserter. The inserter inserts the documents into a waiting envelope. The inserter seals the envelope or not, depending on the settings. Automatic monitoring ensures the correct number of inserts per envelope.

Operating panel (6)

The machine is programmed and operated from the operating panel.

Operating Controls

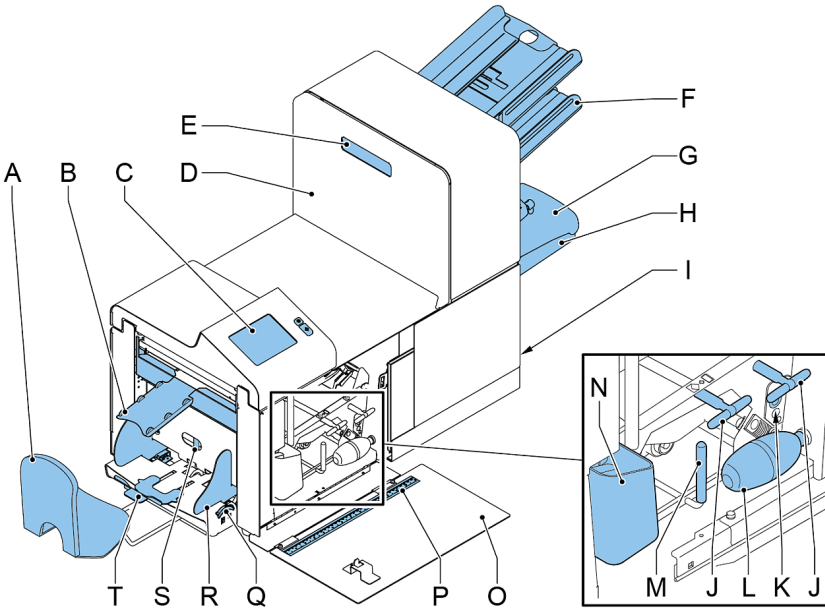

MyBinding.com
 5500 NE Moore Court
 Hillsboro, OR 97124
 Toll Free: 1-800-944-4573
 Local: 503-640-5920

A - Envelope catch tray	K - Sensors
B - Envelope slide	L - Bellows
C - Display with operating buttons	M - Handle for clearing stoppages
D - Upper unit	N - Sealing liquid reservoir
E - Locking hand grip upper unit	O - Side cover (opened)
F - Document feeders	P - Ruler
G - Collator arm	Q - Thumb wheel for side guide adjustment
H - Collator area	R - Side guides envelope hopper
I - Power inlet, power switch, RS232 connector / USB / modem	S - Knob for separation adjustment
J - Knobs for clearing stoppages	T - Envelope support bracket

Control Panel



The control panel consists of the touch screen and the following buttons:

Stop (): The system completes the current mail set and stops, leaving the system empty and ready for a new set.

Start (): The system starts to process mail sets.



The display is covered with a thin pressure-sensitive layer. To avoid permanent damage of the display, do not use sharp objects to press on the display.

MyBinding.com
 5500 NE Moore Court
 Hillsboro, OR 97124
 Toll Free: 1-800-944-4573
 Local: 503-640-5920

Installing the Document Feed Trays

Place the document feed trays in position:

1. Hold the document feeder slightly inclined as shown in the figure.

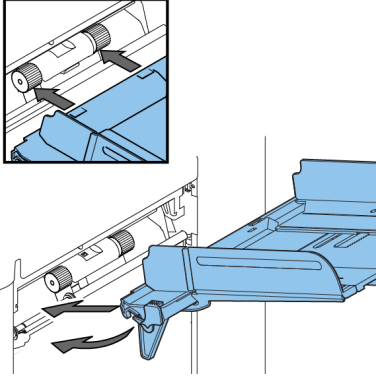

2. Place the front end of the document feed tray underneath the two rollers.
3. Move the document feed tray upwards (lifting the two rollers), until it is possible to 'hook' the feeder into place.

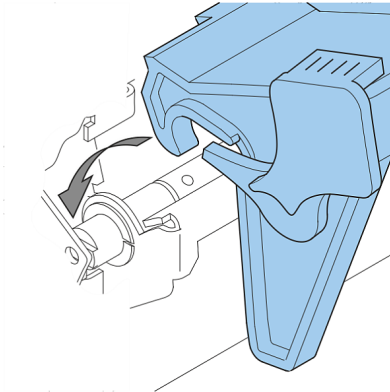

4. Move the document feed tray towards the machine and move the hooks over the mounting points (on both sides).
5. Let the document feed tray rest on the machine.

MyBinding.com
5500 NE Moore Court
Hillsboro, OR 97124
Toll Free: 1-800-944-4573
Local: 503-640-5920

Installing the Slide and Catch tray

To install the slide and the catch tray:

1. Attach the slide as shown in the figure.

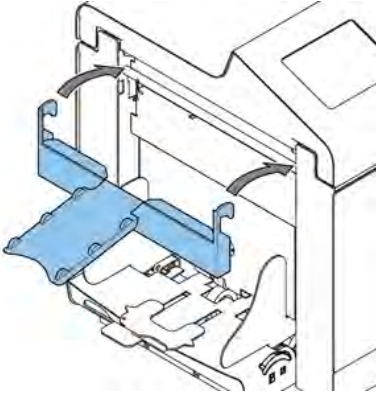

2. Position the envelope catch tray into the holes underneath the envelope hopper as shown in the figure. The distance **A** should be approximately 1.5 x the envelope height.

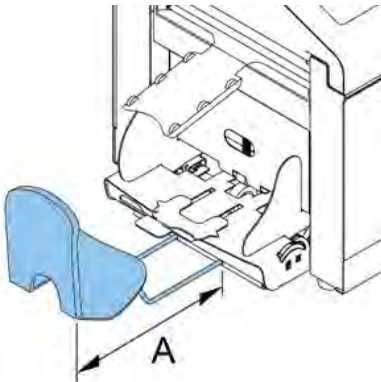

Power Up

To start up the system:



You can severely damage the machine if it is connected to the incorrect power supply. Before plugging in the machine, check if the local voltage is the same as the voltage mentioned on the type plate.

1. Connect the system to the mains power supply.
2. Use the power switch to switch the system on. The power switch is located on the right-hand side of the system.

The touch screen shows the home menu.



Home Menu



When you start up the system, the 'home' menu appears. With the arrows you can scroll through the jobs. If you want more information on a job, select the job.

If you just want to start without job definition, press **[New job]** and select **[Automatic]** (see [Processing mail sets](#) on page 23).

With the home button  you get back to the home menu. The **[Menu]** button opens the advanced settings menu (see [Opening the Advanced Settings](#) on page 47).

Job Info

If you want more information on a job, select the job in the 'home' menu.

The 'current job' menu shows the following information of the selected job:

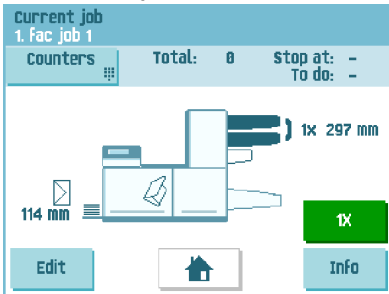

- Job number and Job name
- Total: total number of envelopes that have been processed using this job
- To do: number of envelopes to do. Only indicated if a 'stop at' value is set.
- Stop at: number of processed envelopes at which the system stops. You can set this number with the **[Counters]** button.







You can set it between 0 (switched off) and 9999. The system will continue until the job counter reaches the stop counter value. The system stops and can be restarted. The stop counter is switched off when it is set to zero.

If you want to reset the daily job counter and the stop counter, press the **[Reset TOTAL Counter]** button in the 'counters' menu.



The counter settings are job related.

- A picture of the system with symbols for the selected features. The following symbols can be used:

	<p>Shows the feeders selected to pick documents from (black is selected). Every selected feeder shows how many sheets will be fed from the feeder and the length of the sheets.</p>
	<p>This sign indicates that the relevant feeders are linked. This means that when one feeder is empty, the system automatically starts picking documents from the other feeder.</p>
	<p>This sign indicates that for the selected feeder OMR is switched on (optional).</p>
	<p>This sign indicates that the relevant feeder is set for daily mail.</p>
	<p>Gives information about the envelope size (ISO format or height in mm). An envelope with a cross means that no envelopes are used.</p>
	<p>Shows the type of fold, in this case C-fold.</p>
	<p>The sign indicates that for the relevant feeder the double feed detection is switched on.</p>

- **[Edit]**: use this button to edit the job (see [Editing a job](#) on page 34).
- **[Info]**: if you press the **[Info]** button, the screen shows how to position the envelope and documents in the feeders. From this menu you can press a button to view the reading settings and insert'n |

Side Guides

To adjust the side guides it is best to remove the document feed tray from the feeder as follows:

1. Push handle **A** downwards.

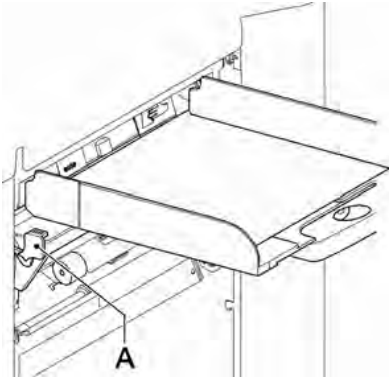

2. Lift the document feed tray upwards to unhook it and then pull it out from the feeder.
3. Loosen the knob **B** half a turn.

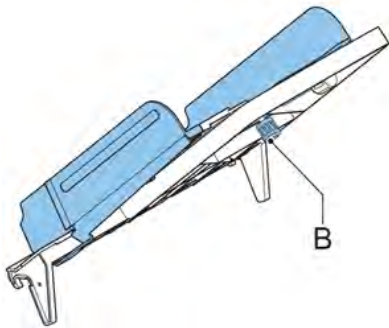











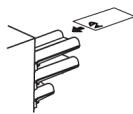
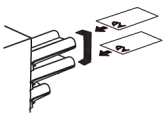
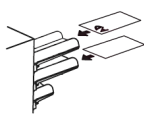
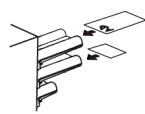

4. Grab the side guides in the middle and push them apart as far as possible.
5. Put a small stack of documents between the side guides.
6. Grab the side guides in the middle and push them towards the documents. The space between the side guides and the documents should be such that the documents have just enough play to move freely.
7. Re-tighten knob **B**.
8. Remove the stack of documents.
9. Replace the document feed tray (see [Installing document feeders](#) on page 10).

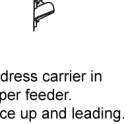
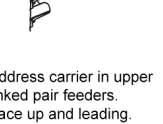
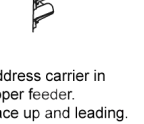
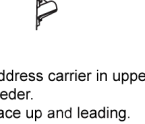
Document Orientation

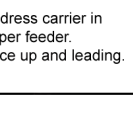
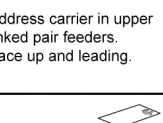
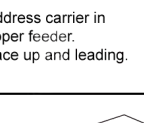
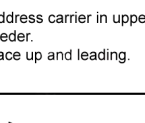
2

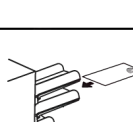
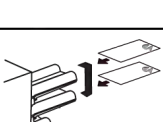
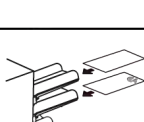
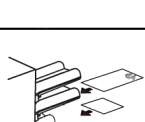
English

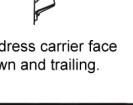
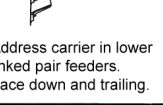
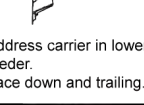
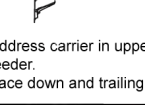
	 one document	 feeder linking	 two documents	 document + enclosure
no fold 				
V-fold 				
C-fold 				
double V-fold 				
Z-fold 				

Filling the Document Feeder Tray

Fill the document feeder tray as follows:

1. Open the left-hand side guide **A** by turning it downwards.
The feed rollers will automatically be lifted.

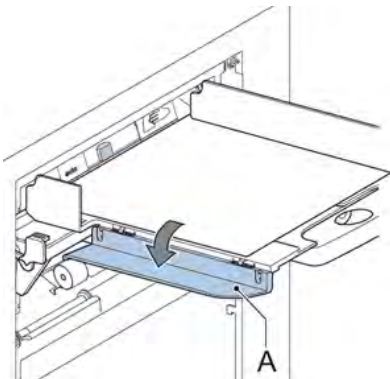

2. Place a stack of documents between the side guides.
3. Turn the left side guide upwards again.
4. Feed the documents (depending on the type of documents and the type of fold) (see [Document Orientation](#) on page 16).

Loading Envelopes

Before you load the envelopes, make sure the envelope separation and side guides are correctly set. Proceed as follows:

1. Rotate thumb wheel **D** to move the side guides **C** apart.

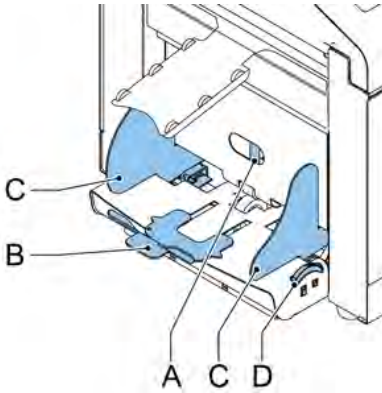

If the distance between the side guides is too large, the envelopes will twist sideways, when transported into the machine.

2. Turn knob **A** counter-clockwise as far as possible.

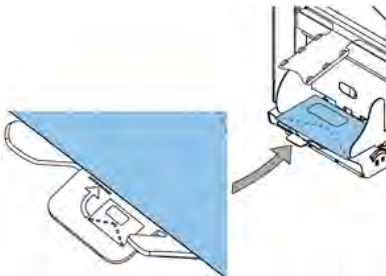

3. Slide an envelope (with closed flap) between the rollers in the machine and turn knob **A** clockwise until a slight resistance is felt when moving the envelope in and out of the machine.
4. When the resistance is too high, turn knob **A** counter-clockwise, until only a slight resistance is felt.

5. Place the bottom envelope between the rollers (flap down and trailing - bottom side of the envelope pointing to the machine).

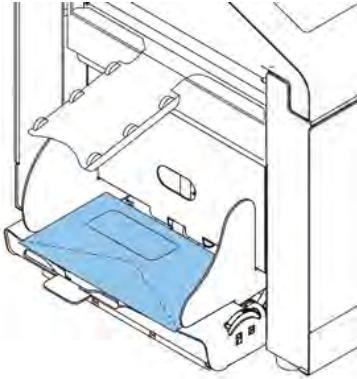

6. Loosen the stack of envelopes, and place the stack on top of the bottom envelope.
7. Shift envelope support **B** in or out, so that the flap side of the envelope is lifted approximately 20 mm (0.8").
8. Turn envelope support **B** so the weight of the envelopes is evenly distributed on both sides.

Sealing Envelopes

Switch the envelope sealing on or off:

1. Lift the handgrip to open the top cover.

- Shift the blue handle **A** towards



to disable the envelope sealing or towards



to enable the envelop sealing.

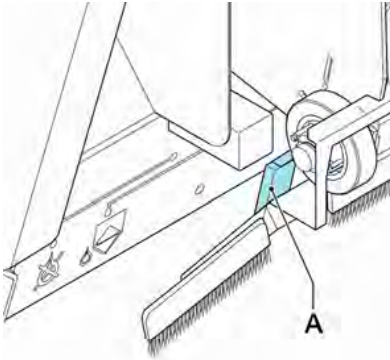

- Close the top cover.

Before you start a job with sealing, wait approximately 5 minutes for the brushes to moisten or use moistened brushes. For instructions on the installation of brushes, see [Clean and replace brushes](#) on page 61.

Filling the Sealing Liquid Reservoir

- Open the front cover **A**.

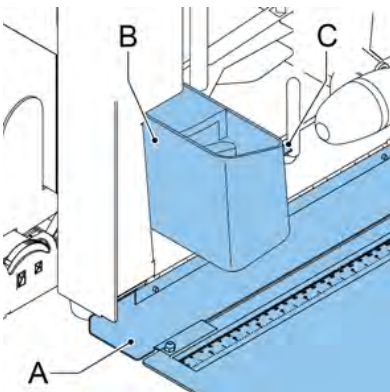

2. Fill the reservoir **B** to the "Max" lip **C** with sealing liquid.
3. Close the front cover **A**.

Before starting the job, wait approximately 5 minutes for the brushes to moisten.

Before starting the job, wait approximately 5 minutes for the brushes to moisten or use moistened brushes. For instructions on the installation of brushes, see [Clean and replace brushes](#) on page 61.

For good moistening, regularly check that the sealing liquid reservoir is filled.

Shut Down the System

1. Use the power switch to switch off the system. The power switch is located on the right-hand side of the system.
-

3 Options

Side Exit

The system can be equipped with a side exit and catch tray. The side exit can be fitted instead of the standard envelope receiving tray. The side exit allows a conveyor or a franking system to be fitted in line with the system. The side exit can also be used with a catch tray to achieve vertical stacking. The catch tray is delivered with the side exit.

insert'n Frank / insert'n Mail

4 Processing Mail Sets

Introduction

With the system you can process mail sets in the following ways:

- **Automatic job:** The system automatically picks one sheet from each filled feeder and processes them into mail sets. The automatic feature is described in this chapter.
- **Manual job:** various settings, not available in an Automatic job, can be stored for re-use in user-programmable jobs (Manual jobs). This includes the use of daily mail. Working with manual jobs is described in [What is a job](#) on page 29.

Automatic job processes mail sets according to the following rules:

- The machine picks one sheet from each filled feeder;
- The picked documents will be folded (if necessary) and inserted into an envelope;
- Only the feeders that feed successfully will be selected;
- Only the Double Feed Control (DFC) of the upper feeder will be selected (this is done automatically).

The following features are not supported with Automatic job processing:

- Linked feeders (the option where, if one feeder is empty, the system automatically continues using another feeder);
- Multifeed (picking more than one sheet from a certain feeder);
- Daily mail (see [Processing Daily Mail](#) on page 25);
- Reading functionality (see [Reading Introduction](#) on page 52);
- No envelope mode (see [Envelope settings](#) on page 38);
- Envelopes with open flap (see [Envelope settings](#) on page 38).

If you want to use any of these features, you have to use Manual jobs to process the mail set (see [What is a job](#) on page 29).

Processing a Basic Mail Set

A basic mail set consists of documents from one or more document feeders. This set is inserted into an envelope.

Before you start, make sure you have read the [Introduction on processing mail sets](#) on page 22.

1. From the home menu, press the **[New job]** button.
2. Choose **[Automatic]** to start an Automatic job.
3. Load the documents and envelopes into the feeders.

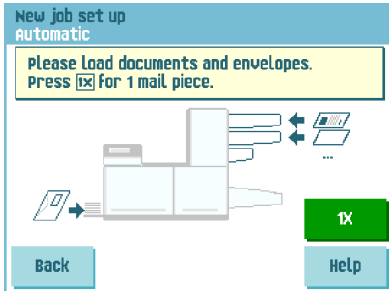

4. Press the **[1x]** test run button to create one mail set and follow the instructions on screen.



After a successful test run, it is possible to use the **[Save]** button to save the settings of the Automatic job to a new job.

5. Press the **[start]** button to start the mail set production.

The system stops producing mail sets when one of the feeders is empty or the **[stop]** button is pressed.

Processing a Mail Set with BRE or Inserts

A mail set with BRE consists of documents from one or more document feeders and an insert/BRE from the BRE feeder. This set is inserted into an envelope.

Before you start, make sure you have read the [Introduction on processing mail sets](#) on page 22.



Load the BREs with the flap down (flap leading).



If a short feeder is present, load the BREs in the short feeder.

If no short feeder is present, BREs can be loaded in the standard feeders.

1. From the home menu, press the **[New job]** button.
2. Choose **[Automatic]** to start an Automatic job.
3. Load the documents, BREs or inserts and envelopes into the feeders.

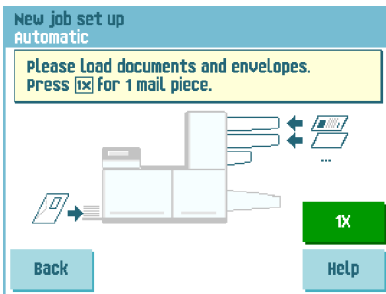

4. Press the **[1X]** test run button to create one mail set and follow the instructions on screen.
5. Press the **[start]** button to start the mail set production.

The system stops producing mail sets when one of the feeders is empty or the **[stop]** button is pressed.

Document Separation

The term 'Document separation' refers to the adjustment required for separating the upper document from the rest of the documents in the stack. This prevents documents being picked up from the stack at the same time. This machine has automatic feeders only; all document separation is automatically adjusted.

Processing Daily Mail



The daily mail function is only available when reading is not activated. When daily mail is set, the links to the daily mail feeder will be deselected automatically.



When the daily mail function is selected DFC is not available.

To process documents or sets of documents, which can not be processed automatically (e.g. stapled documents), the top feeder is equipped with a daily mail switch.

To use the Daily Mail function:

1. Select a job where the daily mail function is selected. You can recognize the daily mail by the  icon in the job information menus.

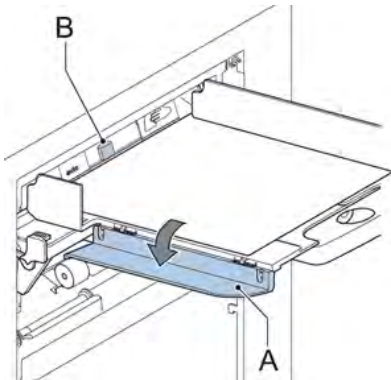

2. Turn down the left side guide **A** of the upper tray. Now you can see the Daily Mail handle **B**.
3. Move the handle to the right to enable the Daily Mail function.
4. Turn side guide **A** upwards.
5. Press the **[start]** button to start the job.

6. Place the document or document set in the feeder (see [Filling the Document Feeder Tray](#) on page 16).
The document or document set will be folded and inserted into the envelope as described in the selected job.
7. Place the next document or document set in the feeder. The system will keep running to process the inserted document or document set.
8. When finished with Daily Mail, press the **[stop]** button to stop the job.
9. Set the Daily Mail handle **B** to the 'AUTO' position to disable the Daily Mail and enable the automatic document separation.

Test Run

Before starting an Automatic job, it is possible to perform a single test run. This test run is intended to validate the settings of the Inserting System:

- Inspect and adjust the stop position of the envelope.
- Check the fold settings for one set.
- Check if the address is correctly positioned behind the envelope window.

Adjusting the Address Position

If the address on your mail is not correctly positioned behind the envelope window, change the address position as follows:



Adjusting the address position is only possible after running a test run (by using the **[1x]** button).

1. Choose a job and press the **[1x]** button.



2. Press **No** if asked if the mail set is correct.
3. Press **Yes** if asked if the documents are inserted correctly.

4. Press **No** if asked if the address is readable.
5. Follow the steps in the wizard.

Adjusting the Envelope Insert Fingers

To make a good insert of the document set into the envelope, the insert fingers **A** should be about 5 mm (0.2 inch) inside the envelope.

The outer fingers should be about 5 to 10 mm (0.2 to 0.4 inch) from the edges of the envelope.

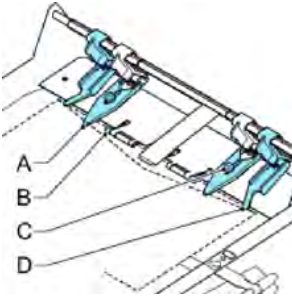

To verify that the position of the fingers is correct:

1. Choose a job and press the **[1x]** button.
2. Follow the steps in the wizard.
3. Loosen the knurled knobs **C**.
4. Adjust the fingers **A** so that the tip is approximately 5 mm (0.2") inside the envelope.
5. Tighten the knurled knobs **C**.
6. Adjust the outer fingers **D** approximately 5 - 10 mm (0.2 till 0.4") from the edges of the envelopes.



Check the position of the insert fingers when changing to a different type of envelope.

Verifying the Insert Position

To make a good insert of the document set into the envelope, the envelope should be positioned correctly.

The document set is inserted correctly if the flap folding line of the envelope is positioned underneath the green roller **B**.

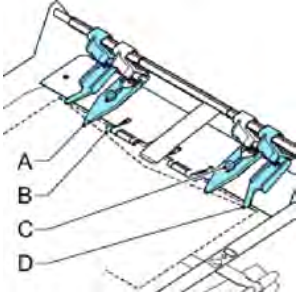

To verify the insert position:



This adjustment must only be checked in case of problems or when changing the envelope type.

1. Choose a job and press the **[1x]** button.
2. Lift the locking lever of the loc and pull the loc into the vertical position.
3. Press **No** until the question about envelope position appears.

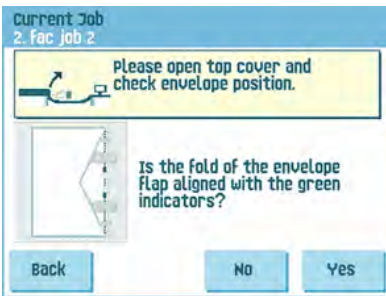

4. Press **No** again and follow the instructions on screen.

5 Working with Jobs

What is a job

If you have to process a lot of mail sets of the same type (for example bills), you can save the settings to a 'job'. The next time you just select the job and immediately start without defining any settings.

The following settings are saved in a job:

- Envelope type/size;
- Which document feeders should be used, how many documents should be fed from each feeder and document height for each feeder;
- Feeder linking on/off;
- If BREs or insert cards should be included;
- Address position;
- Fold settings;
- Double feed control settings;
- Reading settings (option);
- Mailing and Franking settings (option);
- Batch Counter, defining the number of mail sets that the job must process. The job will automatically stop processing when this number is reached.

Creating a new job

To create a new job:

1. From the home menu, press the **[New job]** button.



2. Press **[Manual]** to create a new job.
For **[Automatic]**, see [Processing a basic mail set](#).

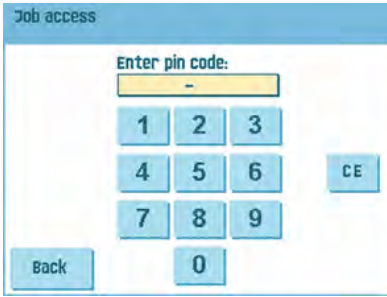

3. Enter the pin code **2546**.

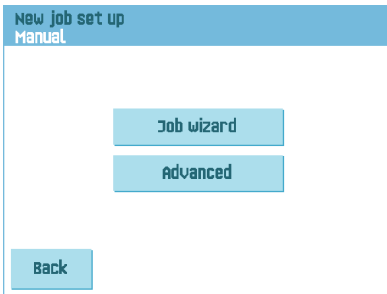

4. Press the **[Job wizard]** button to create a new job with the job creation wizard or press the **[Advanced]** button (experienced users only) to define the settings of the new job. If you use the job creation wizard, follow the steps on screen. If you use the advanced way of job programming, continue as follows:

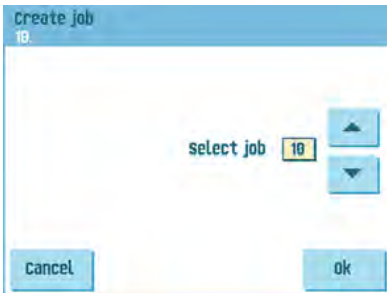

5. Press **[OK]** to confirm the selected free job number.



A new selected job number starts with default settings.

The job settings menu opens. The meaning of all buttons and settings is explained in [Job settings](#).



6. Press **[Save]** to save the job with the entered settings under the specified job number and name.
To name a job, see [Job name settings](#) on page 45.
7. Press the **[1x]** button to verify that the insert position and address position are correct (see [Verifying the Insert Position](#) and [Adjusting the address position](#) on page 26).

Performing a test run

Before starting a job, it is possible to perform a single test run with the settings of the current job.

To perform a test run:

1. In the home menu, use the arrows to scroll through the Job selection list.



2. Select the job you want to use.

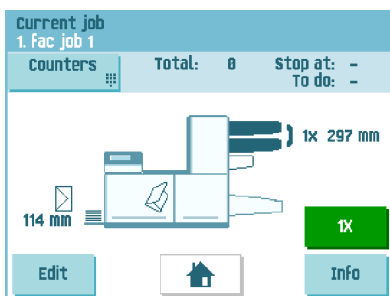

3. Click the [1x] button.
4. Follow the steps in the wizard.

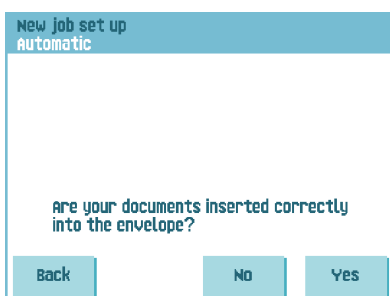

Adjusting the Envelope Position

Before performing a test run, it is possible to adjust the envelope position.

To adjust the envelope position:

1. Press the  button to start adjusting the envelope position.



2. Use the arrows beneath the ruler to adjust the envelope position.

3. Press the  to check the new alignment.



4. Press the **[OK]** button to accept the new alignment.

Using a job

If you want to use an existing job:

1. From the home menu, select the job you want to use.

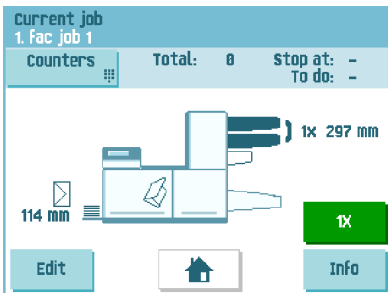

2. If you want to perform a test run:
Press the **[1x]** button to do a test run.
3. If you want to change the counter for this job:
Press the **[Counters]** button to make changes to the amount of mail sets that the job produces.
4. Press the **[Start]** button to start the job.

Editing a job

To edit an existing job:

1. From the home menu, select a job you want to edit.

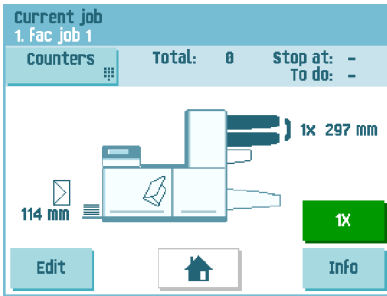

2. Press the **[Edit]** button.
3. Enter the pin code **2546**.

The job settings menu opens. See [Job settings](#) on page 37 for the meaning of all buttons and settings.

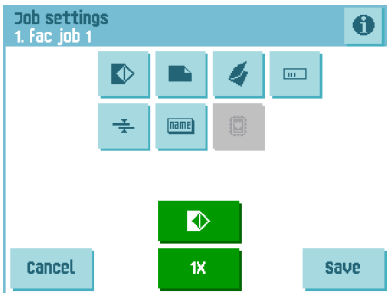

4. Press **[Save]** to save the job with the entered settings under the specified job number and name.
 5. Press the **[1x]** button to verify that the insert position and address position are correct (see [Verifying the Insert Position](#) on page 28 and [Adjusting the address position](#) on page 26).
-

Copying a job

To copy existing job settings to a new job:

1. Press the **[Supervisor]** menu button from the main menu.
2. Enter the pin code **2546**.

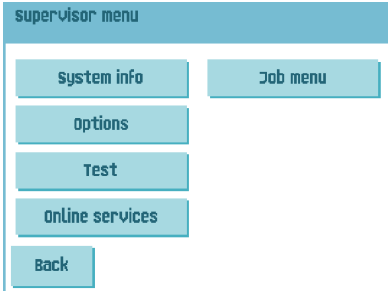

3. Press the **[Job]** menu button.
The job menu opens.



4. Press the **[Copy job]** button.
The copy job menu appears.

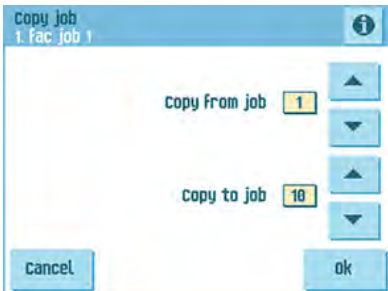

5. Press the arrows if you want to select another job number to copy from or to copy to.



You can only copy job settings to new jobs.

6. Press the  button for details of the job to copy from.
7. Press **[OK]** to copy the job settings.

If all jobs are programmed the touch screen shows “No more free jobs”.

It is possible to copy an Automatic job into a job. Before an Automatic job can be copied, it has to be defined successfully (see [Processing a basic mail set](#) on page 23).

Deleting a job

To delete an existing job:

1. Press the **[Supervisor menu]** button from the main menu.
2. Enter the pin code **2546**.

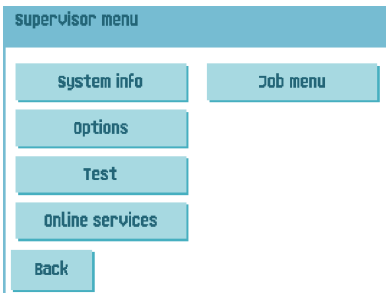

3. Press the **[Job menu]** button.
The job menu opens.

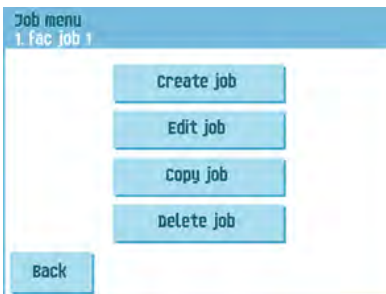

4. Press the **[Delete job]** button.
The delete job menu appears.





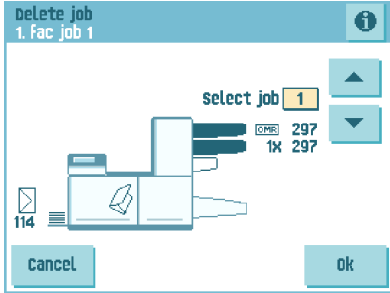



When you press **[OK]**, the job is deleted without a warning.



5. Select a job number and press **[OK]**.

Job settings

From the job settings menu the following settings are available:

-  Envelope settings (see [Envelope settings](#) on page 38);
-  Document settings (see [Document settings](#) on page 39);
-  Fold settings (see [Fold settings](#) on page 41);
-  Reading settings (if installed, see [Reading settings](#) on page 43);
-  Double feed control settings (see [Double feed control settings](#) on page 44);
-  Job name settings (see [Job name settings](#) on page 45);
- 





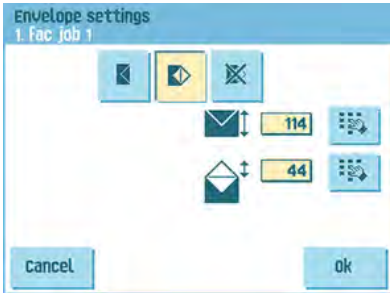

If you want to view the job details of the current job, press the  button. If you want to run a test, press the **[1x]** button.

Envelope settings

In the 'envelope settings' menu you can define the envelope properties.





In the top of the screen, three selection buttons are displayed, from which one can be selected. The selected settings button will be highlighted.

- Press the  button to select an envelope with closed flap. This means that the envelopes are fed with closed flap.
Use the  button to enter the applicable dimensions. It is also possible to select ISO standard envelopes or dimensions in inches (depends on the installation settings). The envelope height can be set between 90 mm (3.5 inch) and 162 mm (6.38 inch).
- Press the  button to select an envelope with open flap. This means that envelopes are fed with open flap. Use the upper  button to enter the applicable dimensions. The envelope height can be set between 90 mm (3.5 inch) and 162 mm (6.38 inch). It is also possible to select ISO standard envelopes or dimensions in inches (depends on the installation settings). Use the second  button to enter the flap height. The flap height can be set between 32 mm and the envelope height minus 32 mm (1.26 inch).
- Press the  button to define a job without inserting the documents in envelopes (no envelope mode). This can be useful for jobs, where documents only have to be sorted and/or folded.

Document settings

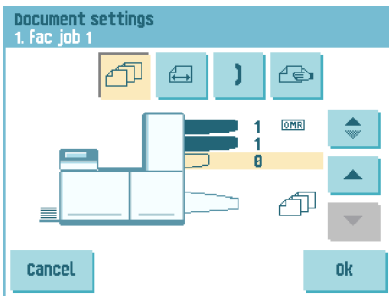
In the 'document settings' menu you define the document formats and the number of documents that must be picked from the different feeders.



- Press the  button to set the number of sheets for the different feeders.
- Press the  button to select a feeder. The selected feeder is highlighted.
- You can feed more than one document for your document set from each feeder. This is called Multi Feed.

Press the arrows to change the number of sheets that must be picked from the highlighted feeder. When the number of documents is 0, the selected feeder will be deselected.





When a feeder is set to daily mail the number of documents is always 1 and can not be set in this menu.

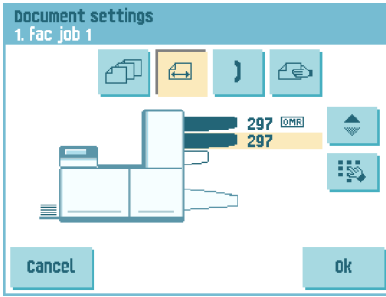

The maximum number of sheets in a set is [25]. When folding is used the maximum set thickness is 5 sheets (80 gr./m2).

- Press the  button to enter the document height. The height or the ISO format of the document will be displayed next to the relevant feeder.





- Press the  button to select a feeder. The selected feeder is highlighted.
- Press the  button to show a numeric keypad to enter the exact dimension of the document.

Dimensions can be entered in mm, inches or as standard ISO paper dimensions (depending on installation settings). The system will not allow entering dimensions out of technical ranges. The document size can be set between 90 mm (3.54 inch) and 356 mm (14 inch).

The default document size setting of a new job is 297 mm (11.7 inch).

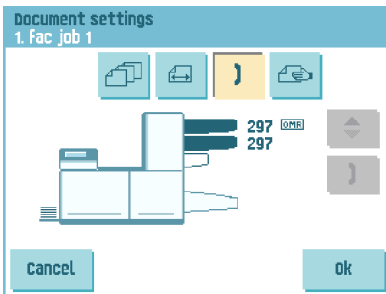
- Press the  button to link two feeders. This function enables to fill two adjacent feeders with the same documents. When the first feeder is empty, the system automatically swaps to the other feeder.







- Press the  button to select two adjacent feeders. The selected feeders will be highlighted.
- Press the  button to link two highlighted feeders. The link-symbol will be displayed between the selected feeders.



When linking two feeders, the program will automatically apply the number and format of the documents of the lowest feeder to the other feeder.



When a feeder is selected for reading, the feeder below can not be linked to this reading feeder.

- Press the  button to enter the setting of the daily mail function. This function enables to process documents or sets of documents, which can not be processed automatically (see [Processing Daily Mail](#) on page 25). The upper feeder is automatically selected.
- Press the  button to enable the daily mail function. The icon  appears behind the upper feeder. If you press the  button again the daily mail function will be disabled.



The daily mail function is only available when reading is not activated. When daily mail is set, the links to the daily mail feeder will be deselected automatically.







When the daily mail function is selected DFC is not available.

Fold settings

In the fold settings menu you can adjust the folding dimensions and folding type.

Select the fold type. The following choices are available:

-  No fold (no settings required)
-  V-fold
-  C-fold
-  Double V-fold
-  Z-fold

Except when no fold is required, the touch screen shows a simple diagram of the document with the fold positions.

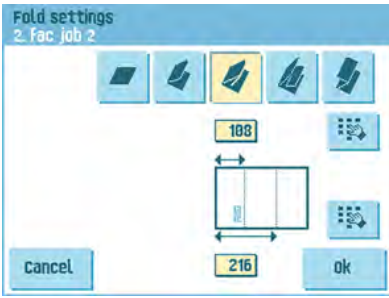

To change the fold positions press the  button next to a fold. Enter the required position of the relevant fold.

Fold type		Minimum position	Maximum position
V-fold		75 mm (2.95")	Longest document length minus 25 mm (0.98")
C-fold	First fold	75 mm (2.95")	Longest document length minus 50 mm (1.97")
	Second fold	Position first fold plus 25 mm (0.98")	Longest document length minus 25 mm (0.98")
Z-fold	First fold	75 mm (2.95")	Longest document length minus 100 mm (3.94")
	Second fold	Position first fold plus 25 mm (0.98")	Longest document length minus 75 mm (2.95")
Double V-fold	First fold	75 mm (2.95")	Longest document length minus 50 mm (1.97")
	Second fold	Position first fold plus 25 mm (0.98")	Longest document length minus 25 mm (0.98")



The touch screen will indicate when entered positions are out of range.

Reading settings (option)

For a full function description of reading, see [Reading Introduction](#) on page 52. In the 'reading settings' menu it is possible to enable or disable the Optical Mark Recognition (OMR) function and to adjust the basic settings. The first 'reading settings' menu covers the following settings:

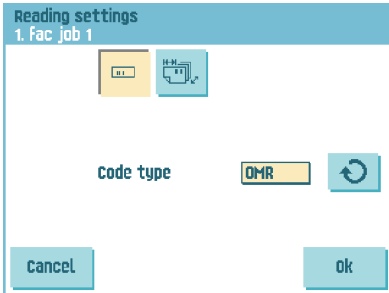

- Code type: default is the setting 'none': reading is disabled.

Change the setting with the  button. The following code is possible:

- 1-track OMR

By pressing the  button the next reading settings menu appears.

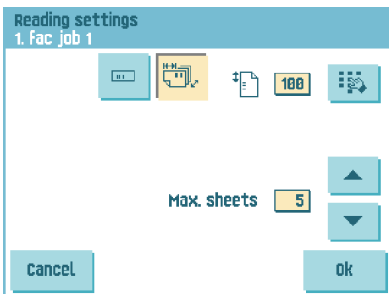





In this menu you can define:

- the location of the OMR code. See [OMR Code Description](#) on page 55 for the correct location.
- the maximum number of sheets. Use the arrow buttons to select the maximum amount of sheets in the set of documents. The maximum number that can be entered here is 5.

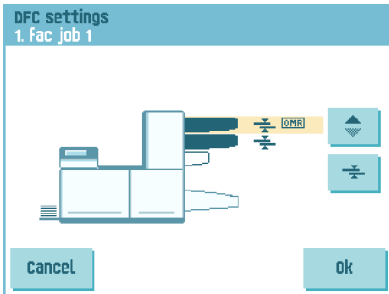
Double feed control settings

In the 'DFC settings' menu you can set Double Feed Control (DFC) for the different feeders on or off.



- Press the  button to select a feeder.
- Press the  button to switch the DFC on or off.
When switched on, the icon is displayed. When a job is started, the first document taken per feeder is used for a reference measurement.
When a document is exceeding that reference thickness an error will be displayed.
- Press the  button to set Continue on double on or off. If Continue on double is on ("yes"), the machine will not stop if two sheets are fed instead of one. The document-set containing the double sheets will be diverted.



When Daily mail is selected, the DFC of the upper (Daily mail) feeder is switched off automatically.

Job name

It is possible to store the job with a meaningful job name, to easily recognize the job. This name is displayed at job selection. Enter a job name with the alpha-numeric keypad.



- Use the  button to clear a character left of the cursor position (backspace).
- Use the **[CE]** button to clear all entered characters and start again.

6 Advanced Settings

What are Advanced Setting?

Advanced Settings are all settings that can be found under the Display Settings Menu and the Supervisor Menu.



The Display Settings menu contains the following settings:

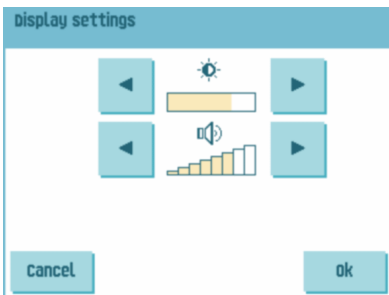

- Set screen brightness (see [Changing the Display Settings](#) on page 47);
- Set interface volume (see [Changing the Display Settings](#) on page 47);

The Supervisor Menu contains the following settings:

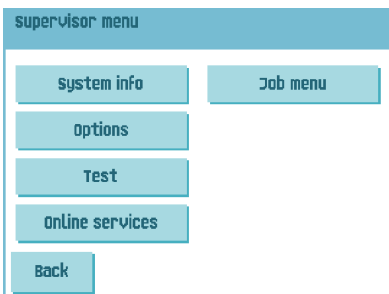

- System info (see Viewing System info and Software versions);
- Options (see [Activating an option](#) on page 49);
- Test (see [Test menu](#) on page 50);
- Online Services (see [Start-up Online Services](#));
- Job menu (see [What is a job](#) on page 29);

Opening the Advanced Settings

If you want to see or edit any of the Advanced Settings:

1. From the home menu, press the **[Menu]** button.



2. Choose if you want to see the Display Settings or the Supervisor Menu. Press the according button to enter that menu. Please note: to access the Supervisor Menu, enter the PIN-code **2546**. After entering the correct pin code the Supervisor Menu appears.

Changing the Display Settings

From the Display Settings screen, you can change various settings.

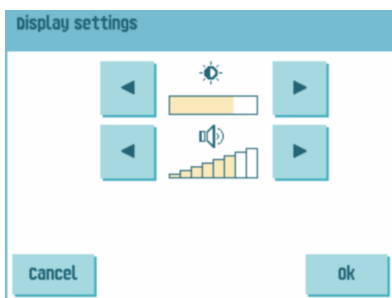

To change the Display Settings:

1. Use the arrows next to the brightness symbol to increase or decrease the display brightness.
2. Use the arrows next to the volume symbol to increase or decrease the interface volume.

Viewing System info and Software versions

From the Supervisor menu, you can view the System info and Software versions.

Proceed as follows:

1. From the Supervisor menu, press the **[System info]** button.

The System info menu opens.

Here, the following information is shown:

- Flex certificate - this option is used for OMR;
- Counter since last visit - the counter value since the last service visit;
- Last error - The last error generated by the system.



2. Press the **[Software versions]** button to view information on the version of the installed software.

The 'software versions' menu opens.

This screen shows the software versions that are present in the total system, see example.

Pressing the **[i]** button shows the subversion revision numbers instead of the standard software version numbers. Generally these are used for development reasons, but sometimes it's convenient to have them for trouble shooting reasons.

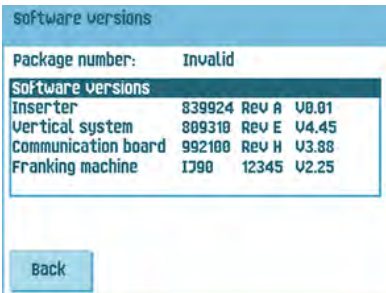

What are licensed options?

The Option menu shows the following information:

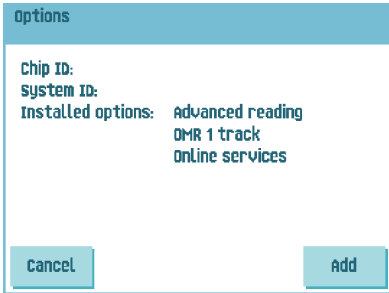

- Chip ID
- System ID
- Installed options.

These software options are enabled using license codes. These license codes, together with the identification number of the machine enable the relevant options. The enabled and available software options are displayed in this screen. Contact your dealer for information about these license codes.

The system supports the following licensed options:

- Advanced reading (see [Reading Introduction](#) on page 52);
- OMR 1 track (see [OMR Code Description](#) on page 55);
- insert'n Frank / insert'n Mail (INF) (see [Mailing and Franking settings](#) on page 45);
- OLS (see [Online Services introduction](#)).

Activating an option

To add a licensed option:

1. In the Options screen, press the **[Add]** button.



2. Use the keypad to enter the license key code that you received from the supplier to activate the relevant option on this machine.
If needed, use the arrow keys to navigate through the entered characters.
3. Press the **[OK]** button to add the licensed option.
The system will now verify the license key.
4. Switch the system off and on.

Test Menu

The Test menu can be used to check the system, reset all photocells and execute reading tests.

The menu consists of the following functions:

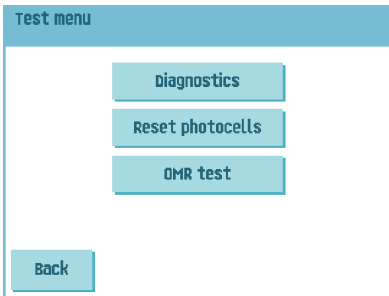

- Diagnostics - Use this function to check if all motors, clutches and sensors are correctly connected. This test derives the status of the actuators and clutches by briefly activating the actuators and then measuring the current (see [Running diagnostics](#) on page 51);
- Reset photocells - Use this function to calibrate all photocells (see [Resetting photocells](#) on page 62);
- OMR test - Use this function to test the OMR functionality (see [Running an OMR test](#) on page 58).

Running diagnostics

To run a diagnostics of the system:

1. In the Test menu, press the **[Diagnostics]** button. The Hardware test screen appears.

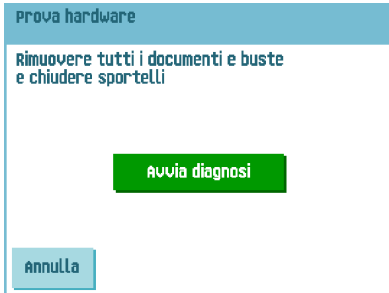

2. Remove all documents and envelopes and close all covers before starting the diagnose.
3. In the Hardware test menu, press the **[Start diagnose]** button. When the test is finished, the Status report is shown, showing a list of all problems found during diagnostics.

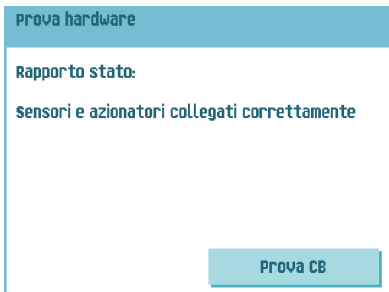

4. If no problems were found, press the **[OK]** button.
If problems have been found that can not be solved, call your service organization.
-

7 Reading

Introduction

The folding and inserting system can be equipped with reading. This allows the system to read special codes that have been printed on the documents. These codes contain information about the processing of the sheets. The following code type is available:

- 1-track basic or advanced OMR: Optical Mark Recognition

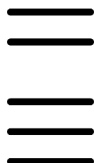

Depending on the settings, the code tells the system if:

- The document set is complete
- Enclosures must be added to the set
- The system must stop
- The set is complete (no pages are missing)

The sheets with the printed code are placed in a feeder. Depending on the programmed code, the other feeders can be used as selective feeders to add enclosures. In case of a Z-fold, the address has to be printed on the last page of the set (see [Document orientation](#) on page 54 for the code position). With the other fold types, the first sheet of a set always contains the address. A full length code is printed on every sheet of a set. The code must appear at the same location on every page regardless of the actual code length.

The code on the last sheet of the set contains the insert instruction. The other sheets carry the accumulate instruction. If a parity check is used with OMR, this is checked on each sheet.

General requirements for printing codes

If you print documents for reading:

- Make sure the ribbon or toner quality is sufficient.
- Print the code in black.
- Marks on the same sheet must have equal intensity.
- Print the code at the same position on every sheet.
- Be aware of "background noise". The reading function can be disturbed by: color changes on the form, background design and a logo or copy on the opposite side of the sheet that will bleed through.
- For matrix printers near letter quality (NLQ) printed characters are preferred to obtain maximum blackness (double strike).



For more information on how to print a reading code on your document, contact your service organization.

7

Adjusting the reading head position

The horizontal position of the reading head must be adjusted to the same position of the printed marks on the documents.

To adjust the reading head, proceed as follows:

1. Fold a document with reading code on the first mark.

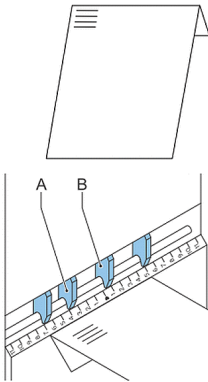

2. Open the top cover.
3. Hold the document in the middle against the ruler.
4. Shift the reading head **A** so it is positioned exactly above the middle of the reading marks.







English

5. Divide the paper guides **B** along the width of the document.
6. When the reading head is adjusted it is possible that paper guides have to be removed and placed on the other side of the reading head.

Document Orientation

Switch on the reading function and set the position of the reading marks as described in [OMR Code Description](#) on page 55.

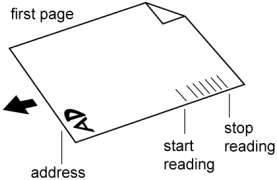
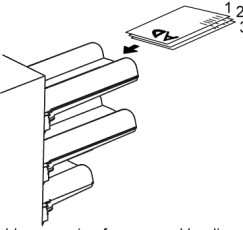
Document orientation:

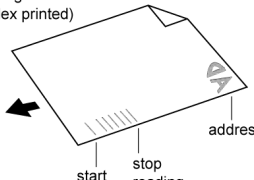
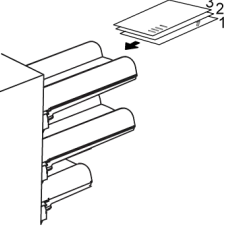
Fold type	Type of documents	Loading positions
no fold  V-fold  C-fold  Double V-fold 	first page  address start reading stop reading	 Address carrier, face up and leading.
Z-fold 	last page (duplex printed)  start reading stop reading address	 Address carrier, face down and trailing.

OMR Code Description

Position of the code on the document:

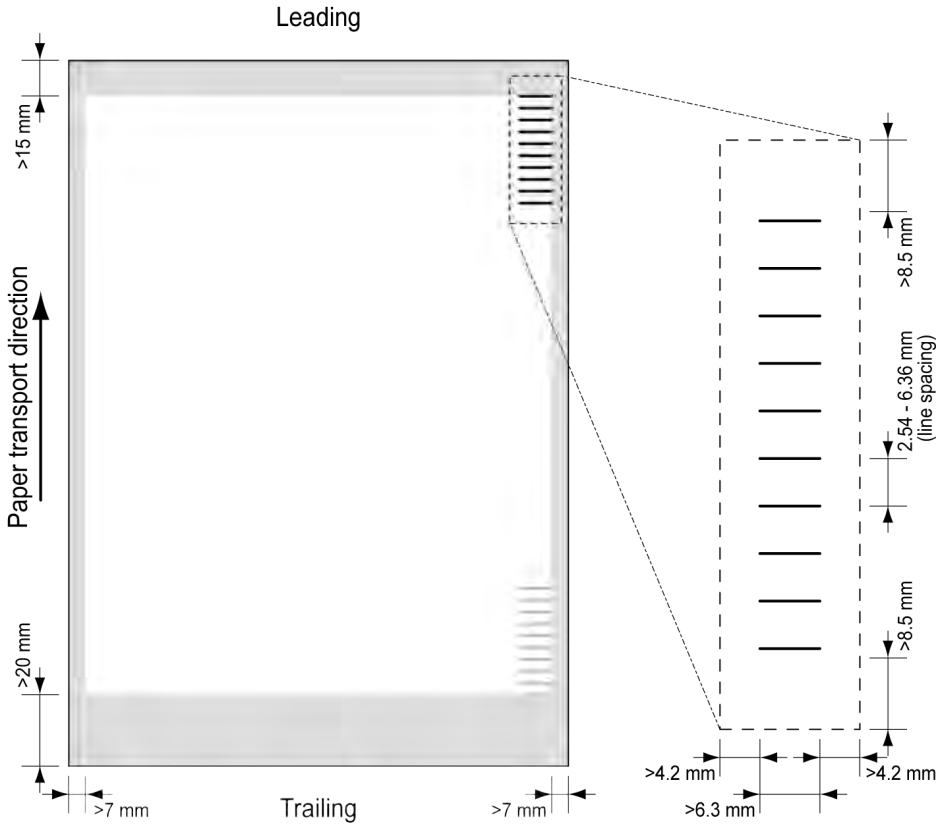

Minimum line thickness of a mark: 0.2 mm (0.008 inch)

Default the first mark from the top is set to: 100 mm (3.9 inch). This parameter is set in the job settings.

The code must have a consistent number of mark positions on every page.

The white area in the picture shows the limits where the code can be printed.

OMR license types

There are two OMR license types:

- Basic
- Advanced

OMR basic license

For the OMR basic license the following functions are available:

- Start mark: indicates the start of the code.
- Insert/Accumulate: defines when a document set is complete and must be inserted into an envelope.
- Parity check: by adding a parity mark the reading code can be checked. The sum of the marks must be even.
- Safety Mark: is used as an extra security. With skewed paper the reading head can miss part of the reading code. In these situations the safety mark is not read, and the system will give an error. The safety mark also indicates the end of the reading code. This mark must always be present on the document if it is part of the code definition.

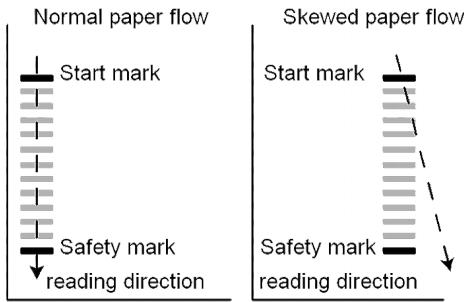

The minimum code is one mark in one line (insert). However for reliability it is advised to use at least 2 marks. The first line is the start mark. A mark printed on the second line means insert. No mark on the second line means accumulate.



In some cases, on request of the customer, the reading of the basic commands can be reversed by the service organization. This means that no mark is interpreted as an insert command and that for the accumulate command a mark has to be printed.

OMR advanced license

For the OMR advanced license the following functions are available:

- The basic functions (Start, Insert, Parity, Safety)
- Divert - The machine stops, manually remove the set from the collator. Reset and start again.
- Stop - The machine stops, manually remove the set from the collator. Reset and start again.
- Selective Feed - The machine will selectively feed an enclosure when commanded so.
- Sequence Check - Sheets in a stack can accidentally get out of sequence or can be missing. This can be detected by the sequence check. Each sheet has a binary code that is a part of the reading code. Depending on the application one, two or three marks are used by sequence check.

OMR general remarks

General remarks:

- In case of OMR the marks must always be used in the sequence as shown in the figure.

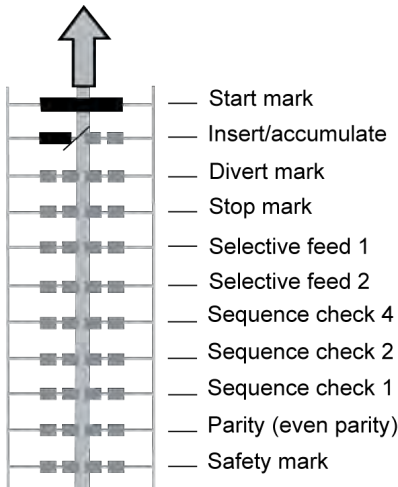

- If a function is suppressed the following function will move upwards one line.
- The mark definition is a service setting.

An Example of OMR Code

In the figure the legend for the following example is shown. In this example feeder station 3 is the reading feeder. The feeder stations 1 and 2 are selected for selective feeding.

In this example, a set of 4 sheets with two selective feeds (station 2 and 1) and three sequence check marks is shown.

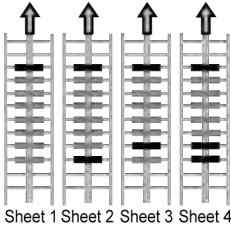

- The first position is used for the start mark which must be printed on every sheet.
- The second mark position is used for the insert/accumulate command. The mark is printed on the last sheet of the set (inserting is required).
- Position 3 and 4 are reserved for selective feeding from station 2 and 1. Print a mark on position 3 when a selective feed from station 2 is required. Print a mark on position 4 when a selective feed from station 1 is required.
- Position 5, 6 and 7 are used for the sequence check marks.

Running an OMR test

To run an OMR test:



Before running an OMR test, select a job that uses OMR reading.

1. In the Test menu, press the **[OMR test]** button. The OMR test menu appears.

OMR code test result

Test result	
Mark quality:	--
Mark(s):	--
Gain setting:	--
Up-p:	--

Back Test

2. Press the **[Test]** button to start the OMR test. After the test is finished, the Result screen appears.

3. In the Results screen, evaluate the test results.
Use the  button to see the OMR info.
 4. Press the **[Back]** button to return to the OMR test menu.
-

8 Operator Maintenance

Maintenance Schedule



Disconnect the mains power supply before performing any maintenance.

The user must not attempt to service the appliance beyond that described in this operator manual. All other servicing must be carried out by qualified service personnel only. Please contact your authorized distributor.

Maintenance frequency	Maintenance
Daily	<ul style="list-style-type: none">• Check the system functions.• Keep the system in proper condition by removing dust, paper remains, etc.
Weekly	<p>The machine is delivered with an extra set of brushes. To always have one clean set available, it is recommended to soak one set in water and use the other set.</p> <ul style="list-style-type: none">• When dirty or saturated, clean the brushes of the envelope sealing or replace them (see Clean and replace brushes on page 61).• When dirty or saturated, clean the moistening cloth or replace if necessary.• Clean feed and insert rollers as instructed by the Service Engineer.
When necessary	<p>When the display warns about dusty sensors, certain sensors have to be cleaned. After cleaning, always calibrate the photocells (see Resetting photocells on page 62).</p> <p>For the sensors on the envelope or document path, see Clean the sensors on the envelope or document path on page 61.</p> <p>For the exit sensors, see Clean exit sensors on page 62.</p>

Clean and replace brushes

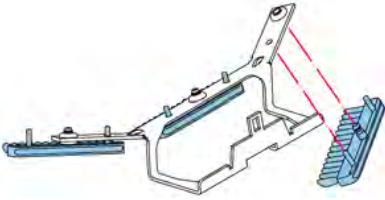

When dirty or saturated, clean the brushes of the envelope sealing or replace them as follows:

1. Moisten the new brushes in water.
 2. Remove the brushes one by one by pulling them down from the brush holder.
 3. Replace the brushes. Make sure that the studs on the brushes are fitted in the corresponding holes in the brush holder.
-

Clean the sensors on the envelope or document path

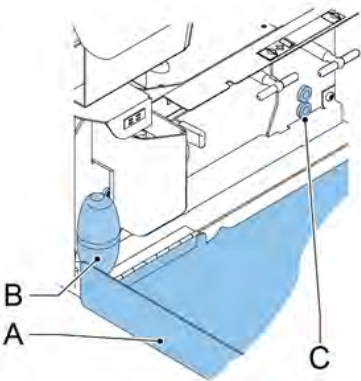

When the display warns about dusty sensors in the envelope or document path, clean them as follows:

1. Open side cover A.
 2. Place bellows B in the upper air plug C and firmly squeeze a few times to blow the dust from the document path sensor.
 3. Place the bellows in the lower air plug and firmly squeeze a few times to blow the dust from the envelope path sensor.
 4. Calibrate the photocells (see [Resetting photocells](#) on page 62).
-

Clean the exit sensors

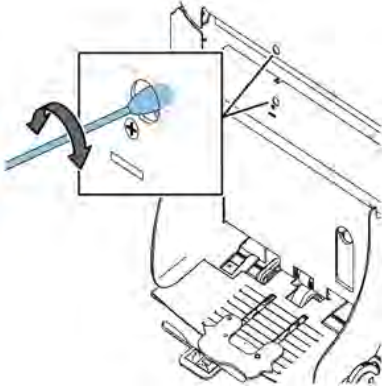

To clean the exit sensors:

1. Rotate a slightly moistened cotton swab in the lower hole, to clean the lower exit sensor.
 2. Rotate a slightly moistened cotton swab in the upper hole, to clean the upper exit sensor.
 3. Calibrate the photocells (see [Resetting photocells](#) on page 62).
-

Resetting Photocells

To calibrate all photocells:

1. In the Test menu, press the **[Reset photocells]** button. The Calibrate photocells menu appears.

Photocells 1/3				
	Current	Voltage	Paper	Status
Env. track	0%	0.0V	0	OK
Flapcell	0%	0.0V	0	OK
Insertcell	0%	0.0V	0	OK
Closercell	0%	0.0V	0	OK
Exitcell	0%	0.0V	0	OK

Press <cal.> to calibrate photocells

Cal.

◀▶ ok

2. Remove all documents and envelopes and close all covers before starting the calibration.
 3. In the Calibrate photocells menu, press the **[Cal.]** button.
When the calibration is finished, the system returns to the Calibrate photocells menu.
-

9 Fault Finding

Error Messages

When an error occurs the display shows a screen showing the following information:

- An indication of the area in which the error occurred
- An error description
- A suggested solution behind the pointing hand

Press the  button to view more information about the occurred error and about the possible actions to avoid the error from re-occurring.

After solving the problem, press **[Reset]** to reset the error (the error screen will disappear).

Special Errors

- Reading errors (when reading is enabled)
The document set is diverted. The operator must remove the document set and has to complete the set manually!
- Technical errors
The display shows a message. The error cannot be solved by operating personnel and assistance of the service support is needed.

Warning Screen

When a cover is opened, the display shows a warning screen with the message "Cover open and a suggested solution "Close cover".

Clearing Stoppages

Stoppages can occur in the following areas:

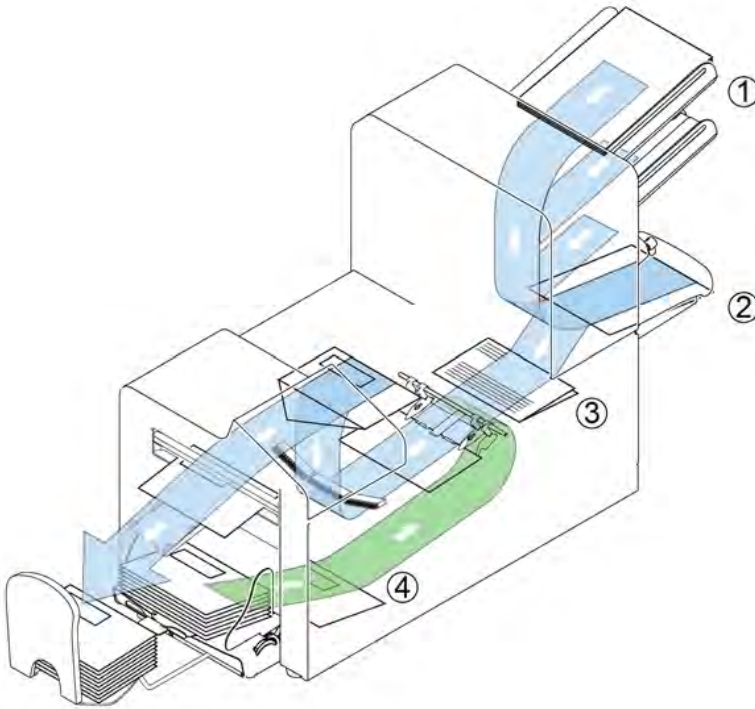

1. Feed area
2. Collating area
3. Fold area
4. Lower envelope track

For clearing of stoppages, three system sections can be opened:

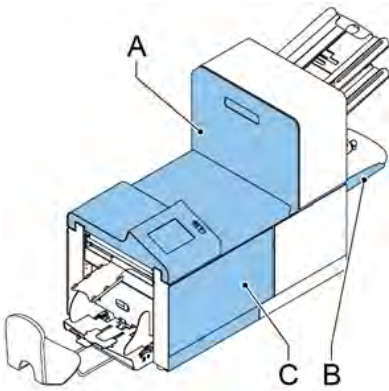

- A - Top cover to reach the Fold and Feed area.
- B - Collator plate to reach the collator area.
- C - Front cover to reach the envelope track and inserter area.

Lower Envelope Track

When a stoppage occurs in the lower envelope track, remove the envelopes as follows:

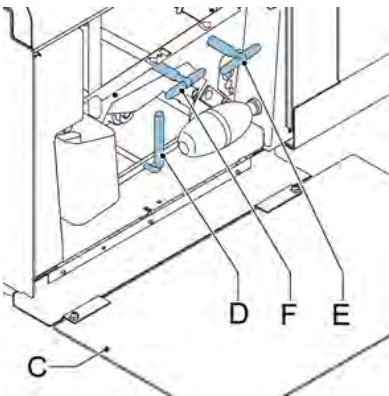

If needed, envelopes can be transported manually to the insert table or lower envelope track by means of handle **F**. To transport a mail set manually, turn handle **E**.

1. Open the side cover **C**.
2. Lower and hold the handle **D** to the left and remove the envelope(s) from the lower envelope track.
3. Release the handle **D**.
4. If necessary, the envelopes and documents can be transported manually by turning the blue knob **E** clockwise.
5. Turn the blue knob **F** clockwise to manually transport envelopes through the lower envelope track.

6. Close the side cover.
7. Press the **[Reset]** button to reset the error and restart the job.

FlexFeed

When a stoppage occurs in the flexFeed, remove the documents from the flexFeed as follows:

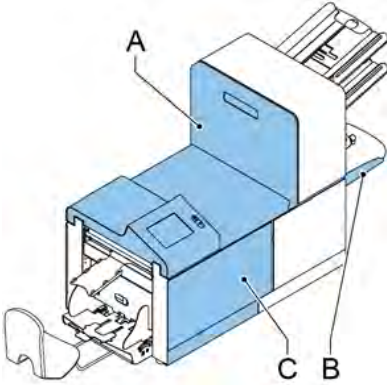

1. Open the top cover **A** by pulling up the handle.
2. Remove the documents from the flexFeed area.
3. Close the top cover **A**.
4. Press the **[Reset]** button to reset the error and restart the job.

Collating Area

When a stoppage occurs in the collating area, remove the documents from the collating area as follows:

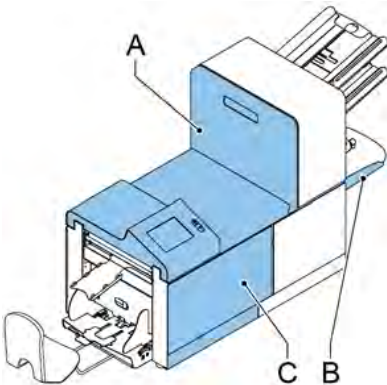

1. Move the collator plate **B** down.

2. Remove the documents from the collator area.
 3. Move the collator plate **B** up in position.
 4. Press the **[Reset]** button to reset the error and restart the job.
-

Fold

When a stoppage occurs in the Fold area, remove the documents from the area as follows:

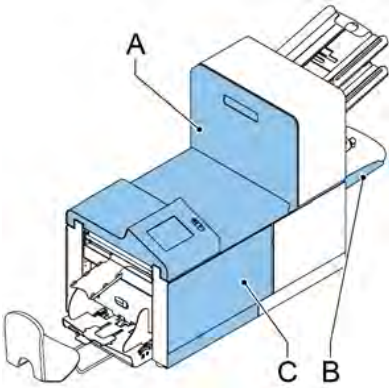

1. Open the top cover **A** by pulling up the handle.
 2. Remove the documents from the Fold area.
 3. Close the top cover **A**.
 4. Press the **[Reset]** button to reset the error and restart the job.
-

Operator Troubleshooting

To resolve problems:

1. Write down the error.
2. Try to solve the problem by consulting the troubleshooting table.
3. Switch the inserter off and on again, to verify system operation.
4. When the error still occurs contact your service organization.



When contacting the service organization, you will also be asked for the last error message and the software version of the installed software. To determine the software version, see Viewing System info and Software versions.

Trouble Shooting Table

Symptom	Possible cause	Remedy	Reference
The system cannot be started after switching on.	System not connected to mains.	Connect the system to the mains.	-
	Fuse is blown.	Replace fuse below power switch.	-
	A cover is opened.	Close the covers.	-
System stops with envelope at insert position (flap not open).	Envelopes stacked reversed in the hopper.	Check envelope feed adjustments. Place envelopes correctly in hopper.	Loading Envelopes on page 17
	Envelope flap sticks.	Store envelopes according to specifications.	Envelope settings on page 38
	Wrong envelope type used (not according to specifications or job settings).	Change envelopes according to specifications.	Envelope settings on page 38
Envelopes are double fed.	Envelope separation not correctly set.	Adjust envelope separation.	Loading Envelopes on page 17
	Envelopes not placed properly in the hopper.	Check and replace if needed.	Loading Envelopes on page 17
Envelope stops skewed.	Side guides of the envelope hopper are set too wide.	Check side guides and adjust if needed.	Loading Envelopes on page 17
Envelopes are fed irregularly.	Hopper almost empty.	Refill hopper.	Loading Envelopes on page 17
	Separation set too narrow.	Adjust envelope separation.	Loading Envelopes on page 17
	Side guides set too narrow.	Check side guides and adjust if needed.	Loading Envelopes on page 17
	Envelope support not positioned correctly.	Reposition the envelope support.	Loading Envelopes on page 17

Flap is wrinkled and sometimes not opened.	Envelope not within specifications.	Check specifications and change envelopes if needed.	Verifying the Insert Position on page 28
	Flap sticks.	Store envelopes according to specifications.	Verifying the Insert Position on page 28
	Flap curled.	Envelopes stored or manufactured improperly.	Verifying the Insert Position on page 28
	Separation set too narrow.	Adjust envelope separation.	Loading Envelopes on page 17
Fingers are placed on top of the envelope.	Fingers adjusted too deep into the envelope.	Check fingers position, adjust if needed.	Adjusting the envelope insert fingers on page 27
	Envelope stops too early.	Check envelope stop position, adjust if needed.	Verifying the Insert Position on page 28
System stops while inserting (stoppage at the inserting point).	Fingers not correctly adjusted.	Check fingers position, adjust if needed.	Adjusting the envelope insert fingers on page 27
	Inserted document too long for used envelope.	Check fold settings.	Fold settings on page 41
	Envelope throat incorrect.	Check envelope specifications.	Verifying the Insert Position on page 28
	Envelope glued inside.	Eliminate faulty envelopes.	-
	Window not glued properly.	Eliminate faulty envelopes.	-

Flap not sufficiently moistened.	Water level low.	Check water level, refill if needed.	Filling the Sealing Liquid Reservoir on page 19
	Brushes dry.	Check brushes, replace if needed by the extra soaked set.	Maintenance Schedule on page 60
	Brushes dirty.	Check brushes, clean if needed.	Maintenance Schedule on page 60
	Moistening felt dry.	Check the moistening felt, refill water tray if needed.	Filling the Sealing Liquid Reservoir on page 19
	Moistening felt dirty.	Check the moistening felt, clean if needed.	Maintenance Schedule on page 60
	Brushes worn out.	Replace brushes.	Maintenance Schedule on page 60
	Moistening felt worn out.	Replace moistening felt.	Maintenance Schedule on page 60
Envelope not always ejected from sealer.	Inserted document too big.	Check fold settings, adjust if needed.	Fold settings on page 41
	Document not inserted deep enough.	Check adjustment of envelope stop position and fingers.	Verifying the Insert Position on page 28
	Sealing area dirty.	Clean sealing area.	Maintenance Schedule on page 60
No document fed.	Feeder empty.	Refill feeder.	Filling the document feeder tray on page 16
	Side guides set too narrow.	Adjust the side guides.	Adjusting the side guides on page 15
Skewed documents fed.	Side guides set too wide.	Adjust side guides.	Adjusting the side guides on page 15

Document set not correctly inserted.	Insert position not correct.	Check insert position.	Verifying the Insert Position on page 28
	Insert fingers not correctly positioned.	Check insert finger position.	Adjusting the envelope insert fingers on page 27
Address not readable from window	Address position not correctly defined.	Check address position.	Adjusting the address position on page 26

MyBinding.com
 5500 NE Moore Court
 Hillsboro, OR 97124
 Toll Free: 1-800-944-4573
 Local: 503-640-5920

10 Specifications

Technical Specifications

	6204Åeries
Type	Inserter system for medium office use.
Theoretical max. speed	2000 inserts per hour, depending on application.
Power consumption	100V AC / 50 Hz / 5.0 Amps. 115V AC / 60 Hz / 5.0 Amps. 230V AC / 50 Hz / 2.5 Amps.
Voltage tolerance	100V: +6% / -10% 115V: +6% / -10% 230V: +10% / -10%
Fuse	100/115 V AC: T 5.0 A, 125 V. Time lag, 5.0 Amps. rated current, 125 V. 230 Vac: T 2.5 A H, 250 V. Time lag, 2.5 Amps. rated current, high breaking capacity, 250 V.
Approvals	EMC Certificate conform EMC-Directive. FCC Certificate conform 47CFR, part 15 CB Certificate conform IEC 60950-1 UL Listed I.T.E. (Information Technology Equipment) Conform UL-IEC 60950-1, file E153801 Conform NEN-EN-IEC 60950-1 and derivatives.
Noise Level	<68 dBA (according to ISO 11202)
Operating temperature	10°C - 40°C (50°F-104°F)
Humidity	30%-80%

MyBinding.com
5500 NE Moore Court
Hillsboro, OR 97124
Toll Free: 1-800-944-4573
Local: 503-640-5920

Hopper and feeder capacity

Envelope hopper	325 envelopes (80 g/m ²)
Document feeder tray	325 sheets (80 g/m ²)

Configuration Dimensions

	1 station	1.5 stations	2 stations	2.5 stations
Height	527 mm (20.7 inch)	527 mm (20.7 inch)	527 mm (20.7 inch)	637 mm (25.1 inch)
Width*	460 mm (18.1 inch)	460 mm (18.1 inch)	460 mm (18.1 inch)	460 mm (18.1 inch)
Length*	765 mm (30.1 inch)	765 mm (30.1 inch)	765 mm (30.1 inch)	765 mm (30.1 inch)
Weight	69 kg (152 lbs)	69 kg (152 lbs)	69 kg (152 lbs)	72 kg (159 lbs)

* Width:

- The optional side exit is 90-195 mm outside the cover (3.5-7.7 inch)

Length:

- with hopper and collator 1120 mm (44.1 inch)
- with standard exit (catch tray) 1260-1360 mm (49.6-53.5 inch)
- with side exit 1200 mm (47.2 inch)

Document and Insert Specifications

Paper quality

Minimum 60 g/m² (15 lb bond)

Maximum 250 g/m² (62.5 lb bond), when folded max. 170 g/m² (42.5 lb bond)

Booklets up to approximately 1 mm (0.04 inch) thickness, depending on stiffness

MyBinding.com

5500 NE Moore Court

Hillsboro, OR 97124

Toll Free: 1-800-944-4573

Local: 503-640-5920

Paper size

Minimum width: 130 mm (5.1")

Maximum width: 236 mm (9.3"), when folded max. 230 mm (9.1")

Minimum length: 90 mm (3.5"), the minimum document length used for the upper feeder is 115 mm (4.5")

Maximum length: 356 mm (14")

Folding capacity

max. 5 sheets (max. 80 g/m²)

Envelope sizes

Standard BRE (Business Reply Envelopes)

Envelope quality

Minimum 80 g/m² (20 lb bond)

Maximum 120 g/m² (30 lb bond)

MyBinding.com
5500 NE Moore Court
Hillsboro, OR 97124
Toll Free: 1-800-944-4573
Local: 503-640-5920

Envelope and Document Set Specifications

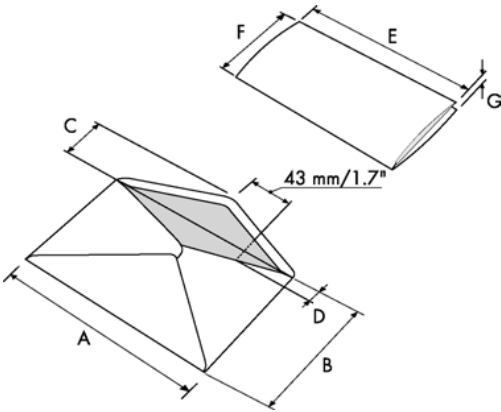

	A	B	C	D	E	F	G
Minimum size	160 mm 6.3"	90 mm 3.5"	32 mm 1.25"	10 mm 0.4"	130 mm 5.1"	84 mm 3.3"	60 g/m ²
Maximum size*	248 mm 9.7"	162 mm 6.38"	B-32 B-1.25	35 mm 1.4"	A-12 ** A-0.47 **	B-6 B-0.2	2.5 mm *** 0.1" ***

* Maximum insert specifications are based on single sheets. When multiples are handled, more room inside the envelope is needed depending on the application.

** When insert is more than 1 mm (0.04 inch): A-15 mm / A-0.6 inch.

*** Booklets up to approximately 1 mm (0.04 inch) thickness, depending on stiffness.

Remarks:

- The specification of the paper handling equipment is often wider than that of the envelopes and documents handled. The condition of material handled will limit the specified environmental conditions.
- We recommend that materials to be handled are stored at a temperature of 20°C (68°F) with a relative humidity factor of 50%. If difference in temperature occurs between store room and mailing area, the material has to be stored near the machine at least 24 hours before use.

MyBinding.com
 5500 NE Moore Court
 Hillsboro, OR 97124
 Toll Free: 1-800-944-4573
 Local: 503-640-5920

11 Terminology

Terminology

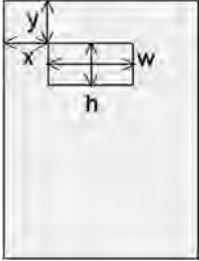
Term	Description
Address carrier	The address carrier is the document that carries the address of the person for who the mail-set is meant. The address must remain visible while enclosures are added and the document-set is folded. The fold type and selected envelope must ensure that the address is visible behind the window in the envelope. For personalized mailings there is always an address carrier present as long as envelope printing is not supported. Normally there is one address carrier.
Address position	 <p>Position of the address on the address carrier, measured from the upper left corner. The address position consists of a horizontal x coordinate, a vertical y coordinate, a horizontal width w and a vertical height h.</p>
Automatic	The feature of an Inserting System to automatically determine its Job settings by measuring the sizes of documents and envelope. From all Feeders that are loaded one sheet will be taken. Based on the maximum document length (which is also the length of the documentset) and the length of the envelope the fold type is determined.
Automatic job	A job that is created with the Automatic functionality.
Business Reply Envelope (BRE)	Envelope included in outgoing mail-sets for addressee response purposes.

MyBinding.com
5500 NE Moore Court
Hillsboro, OR 97124
Toll Free: 1-800-944-4573
Local: 503-640-5920

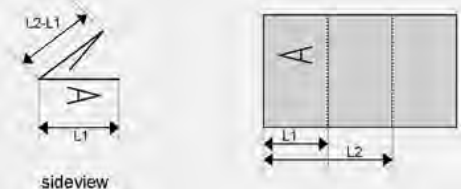
C-fold	<p>Fold type in which a document-set is folded twice in which the folded flaps are on top of each other. This fold is illustrated in the picture below.</p>  <p>The position of both folds is adjustable. Synonym: Letter fold.</p>
Clear	The function of an inserting system in which all mail-sets in progress are finished and the document path is left empty.
Conveyor stacker	Stacks up filled envelopes from the system.
Daily Mail	Capability of an inserting system to manually insert mail-sets one by one into the system, which are then inserted into an envelope. Optionally, depending on settings, additional enclosures can be added and the mail-set can be folded. This function is intended for small amounts of mail that each can have a different build-up.
Document	A document is one of the components of a mail-set. A document can consist of one or more sheets. Documents can be divided into address carriers and enclosures. For personalized mailings there is always one address carrier and an optional number of enclosures.
Document-set	The document-set is the physical collection of address carrier and enclosure(s) that is under production in the Inserting System. The document-set is completed during production and is to be inserted in the envelope. The number of enclosures can range from 0 to the limit opposed by the number of available Feeders. Once the document set has been inserted into an envelope it is called mail set.
Double Feed Control (DFC)	Double Feed Control is the sensor that measures the thickness of a sheet to check if the inserting system does not accidentally take more sheets than intended. DFC sensors exist on Feeders (double sheet detection). Currently DFCs on Neopost inserting systems perform relative measurements, which means that they need a cycle to 'learn' the thickness of a sheet. Also the length of the document is measured so partly overlapping sheets will be detected.
Double parallel fold	See double V-fold.

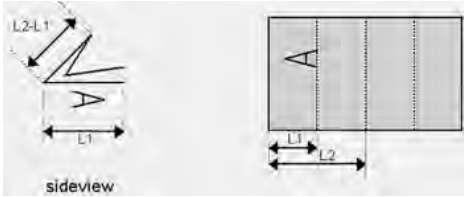
Double V-fold	<p>The double V-fold is a type of fold where the document is first folded halfway and the resulting folded set is again folded halfway. This fold is illustrated in the picture below.</p>  <p>The position of both folds is adjustable. Synonym: double parallel fold.</p>
Envelope	<p>The envelope is the packaging of a mail set. Window envelopes are envelopes that have a transparent section through which the address on the address carrier can be read. Besides the normal top-closing window envelopes there are also bottom-closing envelopes.</p>
Face down	<p>Situation in which the front of a sheet is facing downwards when placed in a document feeder.</p>
Face down leading	<p>Situation in which the front of a sheet is facing downwards and the top of the sheet is closest to the separation unit in a document feeder.</p>
Face down trailing	<p>Situation in which the front of a sheet is facing downwards and the bottom of the sheet is closest to the separation unit in a document feeder.</p>
Face up	<p>Situation in which the front of a sheet is facing upwards when placed in a document feeder.</p>
Face up leading	<p>Situation in which the front of a sheet is facing upwards and the top of the sheet is closest to the separation unit in a document feeder.</p>
Face up trailing	<p>Situation in which the front of a sheet is facing upwards and the bottom of the sheet is closest to the separation unit in a document feeder.</p>
Feeder	<p>A Feeder is a Module for the input of documents to the inserting system. The Feeder separates documents sheet by sheet from the stack of documents in the feed tray.</p>
Feeder linking	<p>The ability to load two feeders with the same document type where the Inserting System automatically switches to a second feeder when the first feeder is empty and vice versa. In the mean time the first feeder can be refilled, so the inserting system can keep running without having to stop for refilling the feeders.</p>
Feed tray	<p>Part of the feeder that contains the stack of documents.</p>
feed	<p>The XXXX feed is the feeding part of the system.</p>

Insert	<ul style="list-style-type: none"> • An insert is the action of inserting a document-set into an envelope. • For native English speaking customers an insert is also a short, not to be folded document, usually an enclosure.
Inserter	An Inserter is the Module where the document-set is inserted into the envelope, the envelope is closed and if necessary sealed.
Inserting system	The system of all the Modules that cooperate to perform the inserting function (accumulate document-set, fold and insert) and have a single point of control.
insert'n Frank /	Interface for the Neopost franking machine.
	<p>A job is an actually produced collection of mail-sets based on a certain Job Definition at a certain point in time for a specific purpose. It consists of:</p> <ul style="list-style-type: none"> • The Job definition used for the production • Information about the batch size
Job counter	The counter that registers the number of mail-sets that is produced as part of a specific job.
Letter fold	See C-fold.
Linking	See Feeder Linking.
Multifeed	The feature of an Inserting System in which more than one sheet is taken from a Feeder.
OMR	See Optical Mark Recognition.
OMR code definition	Standard 1-track OMR code definition. Specifies the amount of reading marks used and the functionality linked to each of them (how each should be interpreted).
Online Services (OLS)	The ability to connect the system to a central server for updates and other communication.
Operator	The person operating a document system.
Optical Mark Recognition (OMR)	Optical Mark Recognition is intended for reading and interpreting printed codes. These codes are one or more black marks which are read from a document. These marks give information to the Inserting system about how to build-up and handle a set.
.....

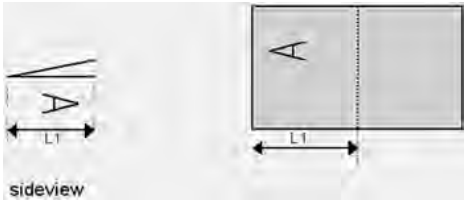

Reading error	Condition in which the system could not reliably read or interpret the OMR reading marks or barcode from a sheet.
Reading marks	Marks added to documents containing finishing instructions that can be identified by a reading head and interpreted according to the used OMR code definition.
Remote diagnostics	The feature that makes it is possible to analyze a problem on an Inserting System from a remote location.
Service engineer	Technical engineer whose task it is to resolve problems with systems in the field. Besides dealing with problems, service engineers are also responsible for preventive maintenance.
Single fold	See V-fold.
Stop counter	Counter which sets the amount of envelopes to be filled. After filling this amount of envelopes the system will stop (even during a clear).
Supervisor	Person who is responsible for the technical state of the machine. Normally a supervisor has access to programming functions, which are restricted for standard users.
Test run	<p>A test run is intended to validate the settings of the Inserting System:</p> <ul style="list-style-type: none"> • Inspect and adjust the stop position of the envelope. • Check the fold settings for one set. • Check if the address is correctly positioned behind the envelope window.
Thickness detection	Checks the thickness of the document set. If the thickness is less or more than the set value an error message is displayed.
Tray	Contains a stack of paper for a printer or inserter. This paper is supplied to the machine for further processing.
V-fold	<p>A V-fold implies the document/set is folded once. The fold-position is adjustable. This fold is illustrated in the picture below:</p>  <p>Synonym: Single fold.</p>
Vertical transport	The vertical transport section between feeders and collator.

Z-fold

A Z-fold means that a document is folded twice in such a way that each folded flap is on a different size of the folded document, resulting in a Z-shape. This fold is illustrated in the picture below.

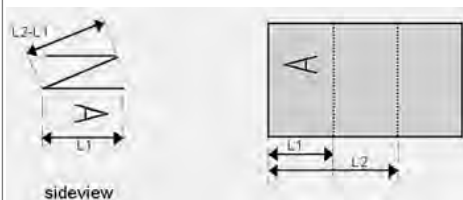

The position of both folds is adjustable. Synonyms: zigzag fold

—

—

—

MyBinding.com
5500 NE Moore Court
Hillsboro, OR 97124
Toll Free: 1-800-944-4573
Local: 503-640-5920

13 Index

13

English

MyBinding.com
5500 NE Moore Court
Hillsboro, OR 97124
Toll Free: 1-800-944-4573
Local: 503-640-5920

Index

B

Brushes 18, 19, 60, 61, 68

C

Can 2, 6, 12, 13, 21, 22, 25, 29, 38, 39, 43, 46, 47, 52, 55, 64, 76, 82

Catch Tray 8, 11

Control Panel 9

Counter 13, 29, 76

Cover 8, 63, 64, 68, 73

D

Diagnostics 50, 51, 76

E

Envelope Hopper 8, 68, 73

F

Feeder 6, 13, 15, 16, 22, 24, 25, 29, 39, 44, 52, 55, 68, 73, 76

H

Hopper 6, 68, 73

K

Keypad 39, 45

L

Language 1

M

Menu 12, 13, 37, 38, 39, 41, 43, 44, 46, 49, 50

N

Normal 5

O

Off 18, 21, 44, 45

Online Services 46, 49, 76

P

Pass Through 45

Power 2, 4, 8, 60, 68, 72

Processing Mail 6, 12, 23, 24

R

Rollers 60

S

Sensors 8, 60, 61, 62

Side Guide 8

Stacker 76

Standard 38, 73, 76, 82

Supervisor 1, 46, 48, 76

T

Task 76

Thickness 6, 39, 44, 55, 73, 75, 76

Time 1, 25, 72, 76

MyBinding.com

5500 NE Moore Court

Hillsboro, OR 97124

Toll Free: 1-800-944-4573

Local: 503-640-5920