

GBC Pinnacle 27 Standard 27" ***Thermal Roll Laminator -*** ***1701700A***

Instruction Manual



Provided by

MyBinding.com
When Image Matters.

Call Us at 1-800-944-4573

GBC Pinnacle 27 Roll Laminator

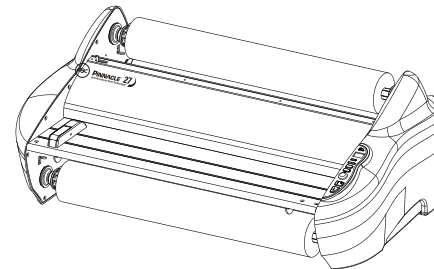
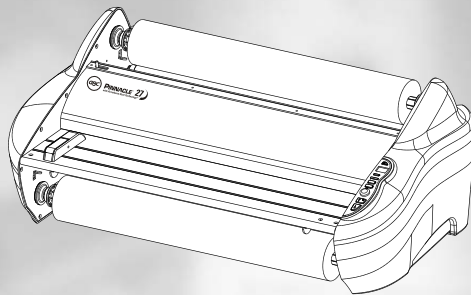

This device complies with Part 15 of the FCC rules. Operation is subject to the following two conditions:
 (1) This device may not cause harmful interference, and
 (2) this device must accept any interference received, including interference that may cause undesired operation.

This Class A digital apparatus complies with Canadian ICES-003.

Cet appareil numérique de la classe A est conforme à la norme NMB-003 du Canada.

© Instruction Manual
 (1701700)

English

4



General Binding Corp.
 Northbrook, Illinois 60062, USA

www.gbc.com

305001163340



To Register this product go to www.gbc.com
 Pour enregistrer ce produit allez sur www.gbc.com
 Para registrar este producto entre en www.gbc.com



MyBinding.com
 When Image Matters.

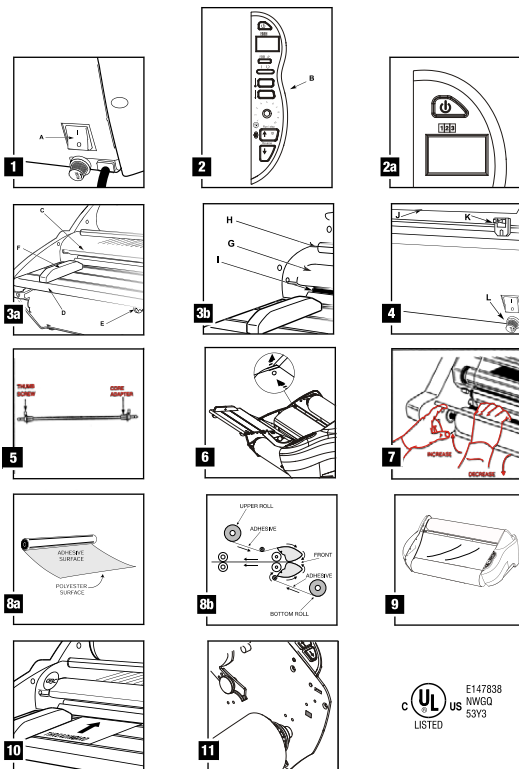

UL LISTED
E147838
NWGO
53Y3

Important Safety instructions

YOUR SAFETY AS WELL AS THE SAFETY OF OTHERS IS IMPORTANT TO GBC. IN THIS INSTRUCTION MANUAL AND ON THE PRODUCT ARE IMPORTANT SAFETY MESSAGES. READ THESE MESSAGES CAREFULLY.

THE SAFETY ALERT SYMBOL PRECEDES EACH SAFETY MESSAGE IN THIS INSTRUCTION MANUAL.

ON THE PRODUCT YOU WILL FIND IMPORTANT SAFETY MESSAGES. READ THESE MESSAGES AND INSTRUCTIONS CAREFULLY. SAVE THESE INSTRUCTIONS FOR LATER USE.

THE FOLLOWING WARNINGS ARE FOUND ON THIS PRODUCT.



This safety message means that you could be seriously hurt or killed if you open the product and expose yourself to hazardous voltage.



Do not touch heat shoes until they have cooled.



This safety message means that you could cut yourself if you are not careful.

WARNING: THE SAFETY ALERT SYMBOL PRECEDES EACH SAFETY MESSAGE IN THIS INSTRUCTION MANUAL. THIS SYMBOL INDICATES A POTENTIAL PERSONAL SAFETY HAZARD THAT COULD HURT YOU OR OTHERS, AS WELL AS CAUSE PRODUCT DAMAGE OR PROPERTY DAMAGE.

WARNING: DO NOT ATTEMPT TO SERVICE OR REPAIR THE LAMINATOR.

WARNING: DO NOT CONNECT THE LAMINATOR TO AN ELECTRICAL SUPPLY OR ATTEMPT TO OPERATE THE LAMINATOR UNTIL YOU HAVE COMPLETELY READ THESE INSTRUCTIONS. MAINTAIN THESE INSTRUCTIONS IN A CONVENIENT LOCATION FOR FUTURE REFERENCE.

Important Safeguards

WARNING: FOR YOUR PROTECTION, DO NOT CONNECT THE LAMINATOR TO ELECTRICAL POWER OR ATTEMPT TO OPERATE UNTIL YOU READ THESE INSTRUCTIONS COMPLETELY. KEEP OPERATING INSTRUCTIONS IN A CONVENIENT LOCATION FOR FUTURE REFERENCE. TO GUARD AGAINST INJURY, THE FOLLOWING BASIC SAFETY PRECAUTIONS MUST BE OBSERVED IN THE SET-UP AND USE OF THE LAMINATOR.

General safeguards

- Use this laminator only for its intended purposes as according to the specifications outlined in the operating instructions.
- Keep hands, long hair, loose clothing and articles such as neckties or ties away from the front of the pull rollers to avoid entanglement and entrapment.
- Avoid contact with the heat shoes during operation or shortly after the laminator has been turned off. The heat shoes can reach temperatures in excess of 300°F.
- Keep hands and fingers away from the path of the sharp film cutter blade located at the film exit.
- Do not place the laminator on an unstable cart, stand or table. An unstable surface may cause the laminator to fall resulting in serious bodily injury. Avoid quick stops, excessive force and uneven floor surfaces when moving the laminator on a cart or stand.
- Do not defeat or remove electrical and mechanical safety equipment such as interlocks, shields and guards.
- Do not insert objects unsuitable for lamination.
- Do not expose laminator to liquids.

Electrical safeguards

- This laminator must be connected to a supply voltage corresponding to the electrical rating as indicated on the serial plate located on the rear of the machine.
- Unplug the laminator before moving it, or when it is not in use for an extended period of time.
- Do not operate the laminator with a damaged power supply cord or plug.
- Do not overload electrical outlets as this can result in fire or shock.
- Do not alter the attachment plug. This plug is configured for the appropriate electrical supply.
- The unit is intended for indoor use only.
- CAUTION:** The receptacle must be located near the equipment and easily accessible. Do not use an extension cord.
- Disconnect the attachment plug from the receptacle to which it is connected and keep the power supply cord in your possession while moving the laminator.
- Do not operate the laminator with a damaged power supply cord or attachment plug, upon occurrence of a malfunction, or after laminator has been damaged. Contact an authorized GBC service representative for assistance.

Service

Perform only the routine maintenance procedures referred to in these instructions.

Do not attempt to service or repair the laminator.

Unplug the unit and contact an authorized GBC service representative for any required repairs if one or more of the following has occurred:

- The power supply cord or attachment plug is damaged.
- Liquid has been spilled into the laminator.
- The laminator is malfunctioning after being mishandled.
- The laminator does not operate as described in these instructions.

WARNING: THIS IS NOT A TOY - DO NOT ALLOW CHILDREN TO OPERATE THIS LAMINATOR!

Installation

- Shipping damage should be brought to the immediate attention of the delivering carrier.
- Place the laminator on a stable flat surface capable of supporting 100 lbs. The surface should be at least 30" high to assure comfortable positioning during operation. All four rubber feet should be on the supporting surface.
- Connect power cord to an appropriate power source. Avoid connecting other equipment to the same branch circuit to which the laminator is connected as this may cause nuisance tripping of the circuit breaker or blown fuses.

Caring for the GBC Pinnacle 27-Roll Laminator

The only maintenance required by the operator is to periodically clean the heat shoes. The following procedure will help keep the heat shoes free of adhesive that has been deposited along the edge of the laminating film.

CAUTION: THE FOLLOWING PROCEDURE IS PERFORMED WHILE THE LAMINATOR IS NOT USE. EXTREME CAUTION.

WARNING: Do not apply cleaning fluids or solvents to the rollers.

WARNING: Do not attempt to laminate adhesives marked "Flammable".

- Remove the film from the laminator following the procedure outlined in the section FILM LOADING AND THREADING.
- Preset the laminator until the READY LAMP () illuminates.
- Clean the top and bottom heat shoes with a soft cloth.
- Follow the procedure in section FILM LOADING AND THREADING, Method Using Film Threading Card to reload the laminator.

NOTE: Do not use metal scouring pads to clean the heat shoes!

WARNING: Do not laminate filter and/or metallic items. Damage to the rollers may result.



Features Guide

A. POWER SWITCH: (figure 1)

Located at the back of the machine, applies power to the laminator. The 'ON' position is indicated by the 'I' symbol. The 'OFF' position marked 'O' symbol.

B. CONTROL PANEL: (figure 2)

- **POWER LAMP (I)**: Indicates that the laminator is plugged into the power source, the main power switch is in the 'ON' (I) position and the stand-by switch (D) is pressed on.
- **READY LAMP (O)**: This will illuminate when the laminator has reached operating temperature.
- **STANDBY SWITCH (D)**: Push to turn laminator on or off when main power switch at the rear of machine is in the 'ON' (I) position.
- **HIGH TEMP SWITCH (H)**: Push to select high temperature setting. Lights red when selected. Refer to Lamination Guide on feed table to select appropriate temperature setting.
- **LOW TEMP SWITCH (L)**: Push to select low temperature setting. Lights red when selected. Refer to Lamination Guide on feed table to select appropriate temperature setting.
- **RUN/STOP SWITCH (R/S)**: Controls the operation of the rollers. Push to select the 'RUN' (R) function and begin lamination. Push again to select the 'STOP' (S) function when the laminated item has passed through the laminator.
- **REVERSE SWITCH (R)**: Push to activate the 'REVERSE' (R) function to clear miss-feeds and jams.
- **SPEED CONTROL KNOB (S)**: Use to select laminating speed.
- **FOOTAGE COUNTER/TEMPERATURE DISPLAY (F/T)**: When MAIN POWER SWITCH is in the 'ON' (I) position and the 'STANDBY' (D) button is pressed to activate machine, display shows laminators temperature while heating. When operating temperature is reached, display defaults to a footage counter. The FOOTAGE COUNTER (F) displays in feet, the amount of film laminated.
- **FOOTAGE COUNTER RESET (F/R)**: Resets the FOOTAGE COUNTER (F) to 0.

C. HEAT SHIELD: (figure 3a)

Prevents inadvertent contact with the heat shoes.

D. FEED TABLE: (figure 3a)

The Feed Table is used to position items for lamination. **The laminator will operate only when the Feed Table and Feed Table Latch are properly installed.**

E. FEED TABLE LATCH: (figure 3a)

Used to lock the Feed Table into position and activate an interlock switch. The latches is located on the right and left underside of the Feed Table. The Feed Table can be removed by retracting the latches and lifting the table upward and away from the laminator. Make sure the feed table latches are properly locked.

F. FEED TABLE GUIDE: (figure 3a)

The Feed Table Guide aligns items to be laminated and is used to ensure that longer items are fed into the laminator straight. The Feed Table Guide may also be used to feed smaller items side by side. Position the Feed Guide toward the center of the Feed Table and position the items to be laminated against each side of the Feed Guide as they are being introduced into the laminator. To position the adjustable guide, lift the latch and slide the guide to the desired position. Then lower the latch.

G. HEAT SHOES: (figure 3b)

Teflon coated heat shoes melt the adhesive on the laminating film before the nip rollers compress it.

H. IDLER BARS: (figure 3b)

The Idler Bars, located near each supply roll, are used to direct the film to the heat shoes. The lower Idler Bar is attached to the Feed Table to facilitate easy film loading.

I. HEATED NIP ROLLERS: (figure 3b)

The Heated Nip Rollers are located behind the heat shoes. The nip point is where the heated film is compressed and pulled through the laminator.

J. PULL ROLLERS: (figure 4)

The Pull Rollers are located at the back of the laminator. They simultaneously pull the film through the laminator and provide tension as the film cools to provide good quality lamination.

K. REAR SLITTER: (figure 4)

Used to cut the film where it exits the rear of the laminator.

L. CIRCUIT BREAKER: (figure 4)

The Circuit breaker is an electrical safety device, located under the main power switch.

M. SUPPLY SHAFT: (figure 5)

The supply shaft holds the film supply rolls. One core adaptor at each end is fitted with a locking collar to insure proper film alignment. **Note: Top and bottom supply rolls must be the same width to prevent adhesive from contaminating the heat shoes and rollers.**

N. AUTO SHUT-OFF:

After two hours of inactivity the laminator will shut down. To activate the laminator, with the main power switch in the 'ON' (I) position, push the 'STANDBY' (D) button on the control panel and wait for the ready light to illuminate.

O. AUTO SHUT-OFF SELECTOR: (figure 11)

Used to enable or disable the Auto Shut-Off feature.

Film Loading and Threading

Refer to Figure 6 and follow the procedures to remove the Feed Table and Heat Shield.

- 1 Remove Heat Shield by sliding lever to the right and lifting the Heat Shield up and away from the laminator.
- 2 Slide the Feed Table latches toward the center.
- 3 Lift the Feed Table up and away from the laminator

CAUTION: HEAT SHOES COULD BURN YOU.

- 4 If reloading film, cut the remaining top and bottom film webs between the supply rolls and heat shoes. **Be careful not to scratch the heat shoes.**
- 5 Change the top and bottom roll at the same time. Use core adaptors and film shaft from previous rolls
- 6 Remove the film rolls by sliding the shaft to the right to release it from the hex shaped brake hub. Loosen the locking screw on the left core adaptor and slide the adaptor off of the shaft. Then slide the film shaft out of the film core. Insert the film shaft into the new roll of film and re-install the core adaptor. Tighten the locking screw. *Note: See figure 8b for diagram on properly loaded film. Be certain that the adhesive side of the film is away from the heat shoe surface.*

- 7 Re-install loaded supply shaft onto the laminator by inserting the shaft into the round hole in the left side frame then into the hex shaped brake hub

7a. Film Tension Adjustment.

Proper film tension is the minimum amount of tension required to eliminate wrinkles in the finished laminated item. The film tension is pre-adjusted in the factory and adjustment by user should not be necessary. To adjust film tension when required:

1. Push and hold the brake lever (figure 7), located on the left side frame near the film roll. Rotate the film roll until the lever engages the internal brake mechanism.
 2. Refer to figure #7 for proper rotation of the film to increase or decrease the tension.
 3. Release the lever and check the tension by rotating the film. Resistance should be slight not forced.
 4. Laminated test samples to check for proper tension.
- 8 Refer to Figure 8 or Threading Guide located on the feed table for illustration of properly loaded film. Unwind top and bottom film rolls allowing enough slack for threading. Drape the film from lower supply roll over the heat shoes allowing enough slack to re-install the feed table/idler bar. **Thread film from upper roll under the idler bar and drape over heat shoes** (Figure 9).

- 9 Re-install feed table and slide feed table latches back to locking position

- 10 Re-install heat shield.

- 11 Press 'Standby' (D) button to activate the laminator and wait for READY (O) light to illuminate.

- 12 Push 'RUN/STOP' button for run function. Slide the threading card (provided with new rolls of GBC laminating film) on the feed table, gently pushing the film into the nip rollers (figure 10). *Note: If the threading card is not engaging the nip rollers, unwind the film a little to provide more slack. The threading card should now be guiding both rolls of film through the laminator.*

- 13 Push the 'RUN/STOP' (R/S) button to stop the rollers when the threading card exits the rear of the laminator.

CAUTION: SHARP BLADE.

- 14 The film cutter may be used to separate the laminated items. Position the cutter in the middle and slide it to both sides, depress the cutter handle while sliding the cutter across the film.

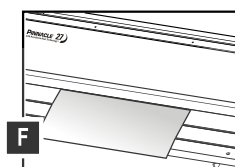
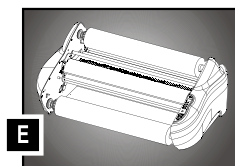
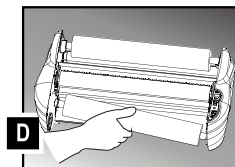
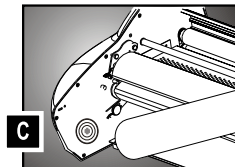
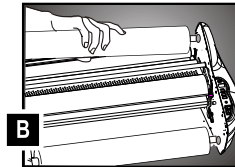
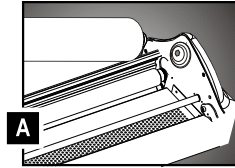

Operation

⚠ CAUTION: MAKE SURE HEAT SHIELD AND FEED TABLE ARE IN THE PROPER POSITION TO OPERATE THE UNIT.

- 1 Move the Main Power switch to the 'ON' (I) position (figure 1). With the main power switch in the ON (I) position, the laminator can be turned on or off using the standby switch (⏻) located on the control panel. When the standby switch is activated the red power indicator (I) will illuminate. The laminator is now heating. Laminator temperature will be displayed.
- 2 Use the lamination guide on the feed table to select the correct laminating temperature and speed for the film gauge and media that you are laminating. The guide will provide a good starting point. You may need to adjust the speed up or down slightly to accommodate the finish or thickness of the media.
- 3 Select laminating speed that fits your comfort level for feeding media into the laminator
- 4 When the laminator reaches operating temperature, the green ready indicator (⏻) on the control panel will illuminate. The display will default to the 'FOOTAGE COUNTER' (⏻) function.
- 5 Position the item(s) to be laminated on the feed table.
- 6 Push 'RUN/STOP' (⏻) button to the 'Run' (⏻) position.
- 7 Slide the item(s) to be laminated into the nip rollers.
- 8 When the laminated items exit the rear of the laminator, push the 'RUN/STOP' (⏻) button to the 'STOP' (⏻) position.
- 9 Use the Rear Slitter located at the back of the laminator to separate the laminated item(s) from the film web.

Clearing a Film Jam (Wrap-Up)

Film jams may occur if the laminator is not positioned to allow exiting film to drop freely to the floor. Accumulation of laminate as it exits the laminator may cause film to wrap around the roller, causing a jammed condition.

To clear a jam it is necessary to rotate the rollers in a reverse direction.

To clear a jam:

- 1 Immediately stop the laminator by pushing the 'RUN/STOP' (⏻) button to the 'STOP' (⏻) position.
- 2 Remove the feed table and heat shield.
- 3 Cut the top and bottom film webs.
- 4 Grasp the loose ends of the web and pull straight out. Install the feed table with the loose ends of the web on top of the table.
- 5 Push the 'REVERSE' (⏻) button and guide the film out of the laminator.
- 6 When the film has cleared the heat shoes, release the reverse switch.
- 7 Thread the film per section Film Loading and Threading.

Specifications

	Pinnacle 27
Operating Speed	Variable
Dimensions (W x L x H)	536 x 900 x 350mm
Net Weight / Gross Weight:	46kgs / 52kgs
Voltage	120V, 60Hz
Current	12A
Power	1580W
Warm-up Time	8-10 minute
Max. Thru Put Thickness:	2mm
Speed 1 ~ 10:	1.4m/4.6ft ~ 3.6m/11.8ft

Electrical requirements - Refer to the serial plate located on the rear of the laminator for the specific electrical rating applicable to the unit.

LAMINATION GUIDE			
Nap I		Nap II	
150°C / 300°F		120°C / 250°F	
1.5mil	3mil	1.7mil	3mil
38mic	75mic	42.5mic	75mic
Speed		Speed	
1-10	1-5	1-10	1-5
This chart is for reference only. Actual Speed setting may vary depending on media thickness and ink coverage.			

This chart is for reference only. Actual temperature setting will vary depending on media thickness and ink coverage.

Laminating Tips

- Do not attempt to laminate abrasive or metal items such as staples or paper clips as they will damage the heat shoes and rollers.

Do not force items into the nip area of the rollers. An item that is not easily drawn into the laminator is probably too thick to laminate.

Wrinkles may result if an attempt is made to reposition an item once the rollers have grasped it.

Do not stop the laminator before an item has completely exited the rear of the laminator. Even a momentary stop will cause a mark (heat line) to appear on the laminated item.

Adhesive will be deposited on the heat shoes and rollers if:

Only one roll of film is used. The top and bottom rolls must be used for problem free lamination.

One or both rolls of film are allowed to run completely off the core.

Troubleshooting Guide

SYMPTOM	POSSIBLE CAUSE	CORRECTIVE ACTION
Power indicator does not illuminate when Standby (⏻) switch is pushed	Main power switch is in The 'OFF' (⏻) position	Move main power switch to the 'ON' (I) position
	Laminator is not connected to power source	Insert plug into appropriate receptacle
	Circuit breaker has opened	Reset circuit breaker
Feed table latches not in position		Move feed table latches into position
Laminated items are wrinkled	Insufficient film tension	Adjust film brake tension
Laminated items are wavy	Excessive heat	Select appropriate heat setting
Laminated items are cloudy	Insufficient heat	Select appropriate heat setting
		Wait for ready light to illuminate
Unsatisfactory adhesion to media	Insufficient heat	Select appropriate heat setting
		Wait for ready light to illuminate
	Media may not be suitable for thermal lamination	The composition or finish of the media may not be compatible with the thermal Lamination process

Warranty

Operation of this machine is guaranteed for **one year** from date of purchase, subject to normal use. Within the guarantee period, GBC will at its own discretion either repair or replace the defective machine free of charge. Defects due to misuse or use for inappropriate purposes are not covered under the guarantee. Proof of date of purchase will be required.

Repairs or alterations made by persons not authorized by GBC will invalidate the guarantee. It is our aim to ensure that our products perform to the specifications stated. This guarantee does not affect the legal rights which consumers have under applicable national legislation governing the sale of goods.

Register this product online at www.gbc.com