

# ***HSM Shredstar BS14c Cross- cut Continuous Operation Shredder - HSM1057***

**Instruction Manual**



*Provided by*

**MyBinding.com**  
*When Image Matters.*

Call Us at 1-800-944-4573

**HSM**<sup>®</sup> *shredstar*<sup>®</sup>

BS14C Paper Shredder  
Instruction Manual



**HSM**<sup>®</sup> *shredstar*<sup>®</sup>

## IMPORTANT SAFETY NOTES



Turn off and unplug the shredder before moving, emptying the waste bin, or if the shredder will not be used for a long period of time.



Keep children and pets away from shredder.



Do not place fingers, hands or any foreign objects in the feed slot. Serious injury may result.



Insert only one credit card at a time.



Keep ties, jewelry, hair and loose clothing away from the feed slot. Serious injury may result.



Do not use canned air on shredder. Never use aerosol, petroleum based or other flammable products on or near shredder.



Do not exceed the recommended paper capacity of 14 sheets. One folded sheet of paper equals 2 sheets. An occasional paper clip or metal staple is allowed.



Shred only one CD, DVD at a time.

- Do not shred envelopes or labels with a sticky substance like glue. Do not shred wet paper, carbon paper or vinyl bags. The shred will stick in the cutters and may cause paper jams or lower shredding performance.
- Empty the wastebasket regularly to prevent paper jams.
- Do not operate if the power cord appears damaged. Do not alter this unit or cord in any way.
- Do not place this shredder near water or any heat source. Keep 6 inches away from wall.
- Do not use any oil or lubricants not clearly specified for shredder use in or around this unit. Some agents may combust causing serious injury.
- If an extension cord is used, make sure that the total ampere ratings of the products plugged into the extension cord do not exceed the extension cord ampere rating, and that the total of all products plugged into the wall outlet does not exceed 15 amps.
- This shredder should be used only with an operator in attendance. Keep shredder in the ON/OFF position and unplug from the AC outlet when not in use for an extended period of time.
- Avoid exposing the shredder to direct sunlight.

## TECHNICAL DATA

Part Number:	HSM1057
Security Level:	3
Shred Size:	5/32" x 1 3/8" (4 x 35mm)(cross cut)
Throat:	8.74" (222 mm)
Maximum Capacity:	14 sheets
Shred Bin Capacity:	5.8 gallons (22 liters)
Voltage:	115 V/60 Hz
Noise level:	58 dB
Weight:	22.9 lbs. (10,4 kg)
Continuous run time	

Note: In order to maintain the machine, we suggest using it got 120 minutes on and 30 minutes off.

### INSTALLATION:

- Unpack and set the machine upright on level surface.
- Make sure the waste bin is properly inserted into the shredder cabinet.
- Plug in the machine. See "TECHNICAL DATA" for necessary precautions.
- The outlet should be installed near the equipment and be easily accessible.

The main connection at the machine must be freely accessible.

### MAINTENANCE INSTRUCTIONS

To ensure proper operation and function, periodic oiling of the cutting system is required. Failure to oil your cutting system could result in reduced sheet capacity performance, excess noise, paper jams and possible machine failure. Run the machine in reverse after every 15-30 minutes of continuous use while applying a thin strip of oil to the cutting head.

- Squeeze the lubricant across the full width of the cutters.
- Clean the shredder housing using a soft cloth dampened with a mild solution of detergent (such as dish washing liquid) and warm water. DO NOT use chemical cleaners or solvents.

### CLEANING PHOTO EYE SENSORS

1. Unplug your machine – for your safety
2. Lift CD Flap on machine (If no flap installed, disregard this line and continue on) Note: In the center of the paper slot, you should see (2) transparent squares - one on either side of the slot.
3. Use compressed air or take a dry tissue or paper towel and wipe back and forth a few times just to dust that area off
4. Replace flap if necessary
5. Plug machine back in

## OPERATING INSTRUCTIONS

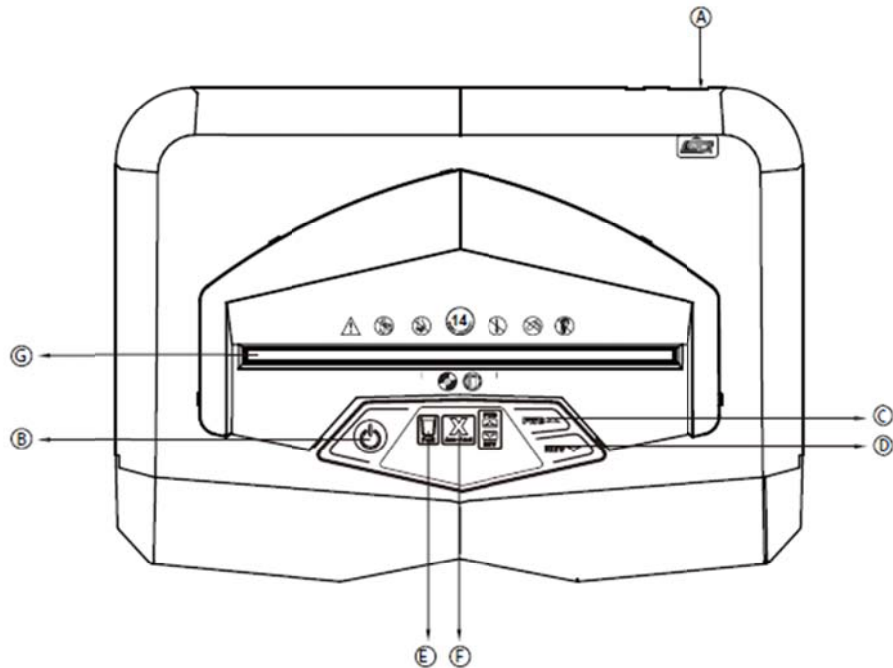

3. To shred a CD, DVD or credit card insert through designated slot ⑥.
4. After shredding, press the stand-by button ③ to turn off the shredder and turn off the power switch in back of shredder ⑤.
5. Empty the waste bin regularly to prevent jams and damage to cutting mechanism.
6. Stand-by button ③ blinks when bin is opened. After bin is returned to engaged position, the machine will resume operation.
7. Cooling fan will operate when shredder is in continuous run mode. Some noise may occur when fan operates.







### JAM-ALERT

This unit is equipped with jam-alert technology. The jam-alert icon ④ will blink indicating that the maximum sheet capacity has been exceeded. Reduce the number of sheets and place the paper back into the paper feed.

## SHREDDER CONTROLS

### Buttons

-  Switch Main Power Switch ⑤ to ON position.
-  Press Power Button ③ to turn on.
-  Press Power Button ③ to turn the power off.
-  Press and hold FWD to manually operate shredder in forward ③.
-  Press and hold REV to manually operate shredder in reverse ④.

## OPERATION

1. Turn on the main power switch in back of shredder ⑤. Press the stand-by button ③. The following function buttons will illuminate: stand-by button ③, the FWD ③ and REV ④.
2. Insert paper into paper feed slot ⑥. Do not feed more than 14 sheets at one time. The shredder will stop after paper has passed through.

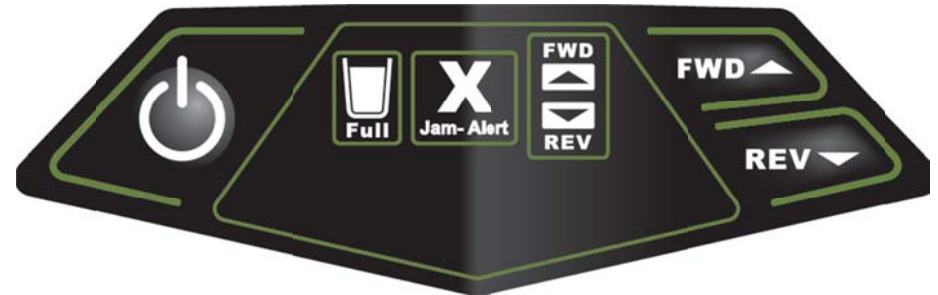

### BIN FULL

When waste bin is full, a green "Full" light will flash ⑦.

## STANDBY MODE

The shredder is equipped with an energy saving standby mode which will activate after 30 minutes of being idle. To resume, press the stand-by button ③.

## TROUBLESHOOTING

### SHREDDER WILL NOT OPERATE

1. Make sure shredder is plugged into power source and the main power switch Ⓐ is switched on.
2. Make sure the waste bin is fully inserted into the shredder housing.

### PAPER JAM

1. Press and hold REV Ⓞ button to clear the jam.
2. Press power button to continue shredding.  
CAUTION: Sharp cutter blades. Do not reach underneath the shredder head to remove jammed paper. Serious injury can result.
3. If the paper jam cannot be cleared by pressing the REV button:
  - a. Tear or cut the remaining paper just above the shredder throat.
  - b. Press power button Ⓞ to switch off the machine.
  - c. Press power button Ⓞ again to switch on the machine in order to clean the jammed paper inside the throat.
  - d. Repeat steps (b) and (c) until all paper is cleared from inside the throat.

### SHREDDER STOPS WHILE SHREDDING

1. Switch off the main power switch Ⓐ and unplug the shredder from the power source.
2. Plug the shredder into power source. Switch on the main power switch Ⓐ in back of shredder and press the stand-by button Ⓞ.
3. For further troubleshooting, please contact product support 800-613-2110.

## STANDARD PRODUCT WARRANTY

Quality is part of the company philosophy and all products are manufactured to the highest quality standards. All technical data and measurements are approximate values and based upon single shift operations. All products are subject to different limits and specifications due to operation length, paper size, grain, weight, misuse/abuse and power configurations.

Prior to operation read the Manufacturers Operating Instructions included with this product. This will help ensure all precautions are taken to avoid cancellation of the manufacturer's warranty.

**The manufacturer warrants that any new products sold will be free from defects in material and workmanship when used under specified and normal operating conditions. This warranty is void if repairs are necessitated by accident, misuse, abuse, water damage or fire.**

The capabilities of all products are in each specification flier. Exceeding model specifications causing product failure is not covered by this warranty. Modifications, alterations and repairs must be performed by an authorized technician. Lubrication for cross cut shredders is required every fifteen to thirty minutes of operation, to maintain top working condition and this warranty.

### Compact Shredders & Shredstar Models

Failure caused by defect is limited to two (2) years from date of invoice. A maximum of one replacement unit is authorized during the warranty period. Strip and cross cut cutting rollers are warranted to be free of manufacturer defects for the life of the shredder from date of invoice.

### Notes:

- Freight or transportation damage is not classified as a warranty repair in any case.
- Proof of purchase invoice is required from the end-user warranty validation or warranty registration date.
- All parts under warranty will be shipped and invoiced using standard costs and will be credited for the full amount only when the defective part is returned.

