

Akiles CoilMax-EX Pro
4:1 Oval Hole Electric Coil
Binding Machine with Electric
Coil Crimper and Inserter

Instruction Manual



Provided by

MyBinding.com
When Image Matters.

Call Us at 1-800-944-4573

Maintenance

It is recommended you lubricate the punching blades inside the machine 1-2 times a year depending on use.

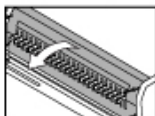

1. Take off the front cover of the machine by first removing the 4 screws.



2. Lubricate the punching blades with lithium or synthetic grease.



3. Punch scratch paper or paper towels to get rid of excess residue.

Technical Information

CoilMac-EX Pro

Fully disengageable pins, Oval (4 x 5mm) holes, 0.2475" pitch



BINDING FORMAT

	CoilMac-EXPro	CoilMac-EX41	CoilMac-EX51	CoilMac-EX06
Legal (14" or 356 mm)	= 54 + 2 holes	= 53 + 2 holes	= 65 + 5 holes	= 55 + 2 holes
Oficio (13" or 330 mm)	= 52 holes	= 53 holes	= 65 holes	= 54 holes
A4 (11.69" or 297 mm)	= 47 holes	= 46 holes	= 59 holes	= 49 holes
Letter (11" or 279 mm)	= 44 holes	= 43 holes	= 55 holes	= 46 holes
A5 (8.27" or 210 mm)	= 33 holes	= 33 holes	= 41 holes	= 34 holes
1/2 Letter (8.5" or 215.9 mm)	= 34 holes	= 32 holes	= 42 holes	= 35 holes

CAPACITY & DIAMETER

No. Sheets (20 lbs)	DOCUMENT		COIL mm	No. Sheets (20 lbs)	DOCUMENT		COIL mm
	inch	mm			inch	mm	
25	1/8"	3.2 mm	5 mm	180	3/4"	19.0 mm	20 mm
35	5/32"	4.0 mm	6 mm	200	25/32"	19.8 mm	22 mm
45	3/16"	4.8 mm	7 mm	230	7/8"	22.2 mm	25 mm
60	1/4"	6.4 mm	8 mm	250	1"	25.4 mm	28 mm
70	9/32"	7.2 mm	9 mm	280	1-1/16"	27.0 mm	30 mm
80	5/16"	7.9 mm	10 mm	300	1-1/8"	28.5 mm	32 mm
100	13/32"	10.3 mm	12 mm	350	1-5/16"	33.3 mm	38 mm
120	15/32"	11.9 mm	14 mm	400	1-9/16"	39.7 mm	45 mm
150	19/32"	15.0 mm	17 mm	450	1-7/8"	47.5 mm	50 mm

Warranty Policy

Your machine has a warranty of one year from the date of purchase. In the event of a manufacturer's defect, your distributor will repair or replace the machine at their option. This warranty does not cover damages due to improper use or mis-treatment of the unit, including any extraordinary event leading to the damage of the machine, whether it is reversible or not.

If the machine is not working properly, please contact your dealer for technical support. Please have your machine's serial number and purchase date ready. If the machine must be returned for repair, it is your responsibility to properly pack and ship the machine as any damage incurred during its transportation is not covered by our warranty policy.

CoilMac-EX Pro

Operation Manual

Features

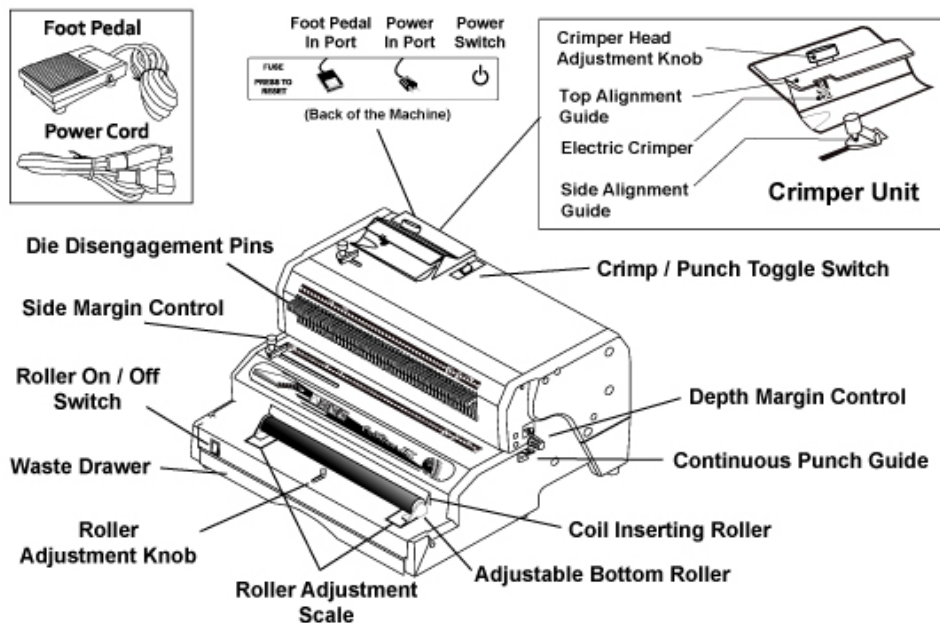

Assembly

1. Place your new CoilMac-EX Pro on top of a sturdy working table (Picture 1).
2. Plug the power cord and foot pedal into the back of the machine (Picture 2).
3. Place the foot pedal on the floor and turn on the power switch behind the machine (Picture 3).

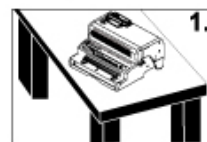

Safety Instructions

- * Keep fingers, hair, jewelry, neckties and any other loose clothing or objects away from the roller, as they may be accidentally pulled into the roller during use.
- * Do not allow children to operate the machine, as it is not a toy.
- * Always turn off the machine and place the foot pedal out of reach when machine is not in use.
- * To reduce the risk of electrical shock, never operate the machine near water.
- * Do not use the machine if the power cord is damaged.
- * Do not allow the electrical cord to be in contact with hot surfaces.
- * In case of malfunction, please contact your dealer for technical support.

Setup

1. Use the included **Coil Size Guide** to determine the correct Depth Margin and Coil Diameter for your book (Picture 1).

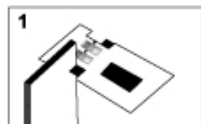

2. Push and turn the **Depth Margin Control** to 1 of 4 colors depending on the size of your book. (Picture 2a). The Depth Margin Control knob should lock into 1 of 4 positions (Picture 2b).

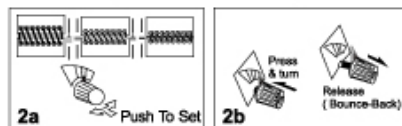

3. OPTIONAL: Use the Coil Diameter Selector to check that you are using the correct coil size for your book (Picture 3).

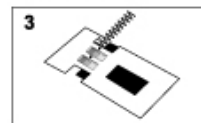

Punching

1. Make sure the **Function Control** on the front of the machine is set to Punch.
2. Use the Punch Throat Ruler and Side Margin Control to center the punching of your document (Picture 1 and 2). To see if you need to disengage any holes, insert a sheet and disengage any hole that is left partially exposed on the Punch Throat Ruler. Failure to do so, will leave a partially punched hole at the edge of your document.

For CoilMac-EX Pro (Oval Holes)

All holes are disengageable which guarantee a clean punch on sheets of any size.

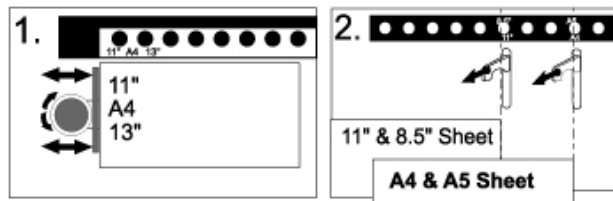

3. Insert sheets and press the foot pedal to punch.

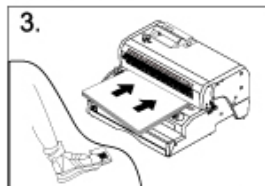

TIPS

Maximum single punching capacity is **25 sheets** (20 lb paper).
Recommended number of sheets per punch (for maximum equipment durability): 20 sheets (20 lb paper).
Empty the waste drawer from time to time. An overfilled waste drawer may cause the machine to malfunction and void your warranty.

For Documents Larger than 14" (356 mm)

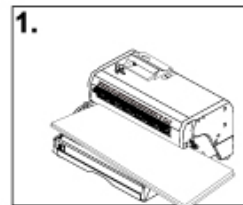

1. Align sheets as indicated on punch throat ruler. Insert sheets and press foot pedal to punch the left side first.

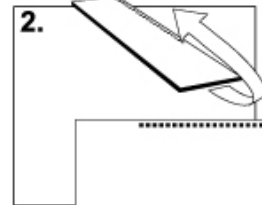

2. Remove the sheets and flip them over as illustrated. The punched holes should now be on your right side.

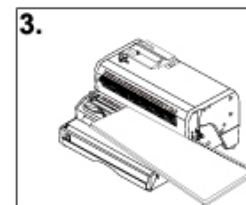

3. Insert the sheet from the right hand side and put the **Continuous Punch Guide** alignment knob into one of the holes. Now press the foot pedal to punch the holes on the left.

IN CASE OF PAPER JAM

The punch cycle will automatically stop when the machine is overloaded with too many sheets. When this occurs, please use the manual jam release.

1. Shut off the power switch.
2. Insert a 6 mm Allen key (not included) into the hole in the left side panel of the machine (Picture A).
3. Rotate the Allen key counter clockwise to pull the punch pins out of the sheet (Picture B).
4. Remove all sheets from the punch throat.
5. Remove Allen key from the machine, then turn ON the power and press the foot pedal to make sure machine operates correctly.

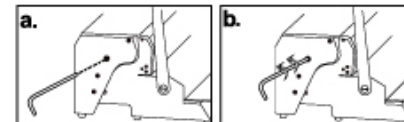

Coil Inserting & Crimping

Inserting

1. Unlock **Roller Adjustment Knob** (turn counter-clockwise) and adjust the **Bottom Roller** forward or backward on the **Roller Adjustment Scale** depending on the size of the coil being used. Lock the **Roller Adjustment Knob** (turn clockwise) once aligned. (See picture 1)
2. Hand insert the coil into the first 4 or 5 punched holes. (See picture 2)
3. Flip the **Roller On / Off Switch** to start the coil inserter. Hold document evenly, so that the coil touches the roller and spins into the book. Once the coil is all the way through, remove the book from the roller. If the coil goes too far, flip the book and spin the coil into the book again. Your goal is to have the coil protrude about 1" on each side of the document. Turn off the **Roller ON / OFF Switch** when you are done. (See picture 3)

Crimping

1. Make sure the **Crimp / Punch Toggle** is set to Crimp. Turn **Crimper Head Adjustment Knob** fully clockwise (6-25 mm) or counter-clockwise (25-50 mm) depending on the coil size being crimped (See picture 4a). Place the booklet on the **Crimper Unit** (See picture 4b).
2. Step on the foot pedal and the electric crimper will cut and crimp one end of the coil. Flip the book and step on the foot pedal to crimp the other side.

Roller Adjustment Knob

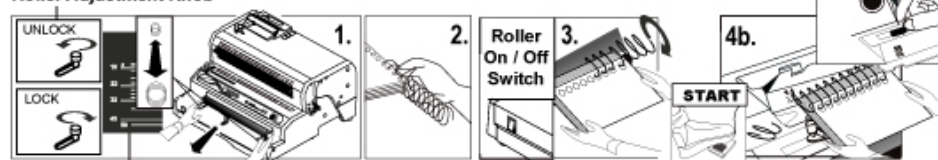

Roller Adjustment Scale