

***Balt 3' x 4' Framed
Magnetic Gloss White Glass
Dry-Erase Whiteboard***

Instruction Manual



Provided by

MyBinding.com
When Image Matters.

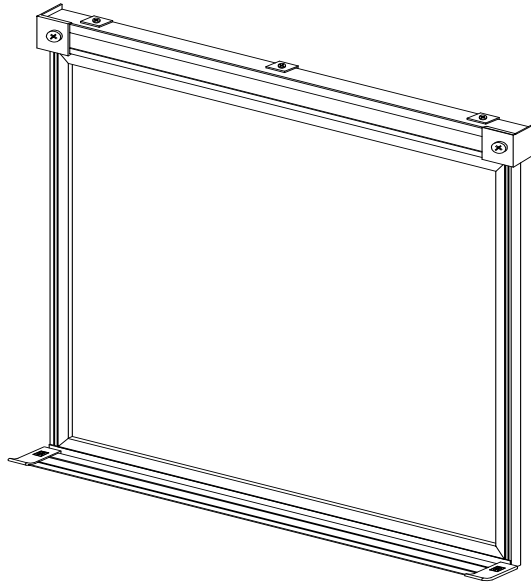

Call Us at 1-800-944-4573

Trimmed Glass Boards

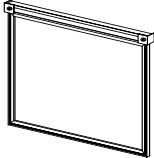
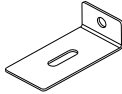

Assembly Instructions

Trimmed Glass Board

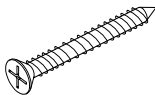
Part	Drawing	Description	Qty	Part	Drawing	Description	Qty
P1		Glass Board	1 EA	<div style="border: 1px solid black; padding: 10px;"> <p style="text-align: center; border: 1px solid black; display: inline-block; margin-bottom: 10px;">Hardware List</p> <p>A  L Clip</p> <p>B  Self Drilling Screw</p> <p>C  Plastic Anchor</p> <p>D  CS Screw</p> <p>E  Drywall Anchor</p> </div>			
P2		Tray	1 EA				

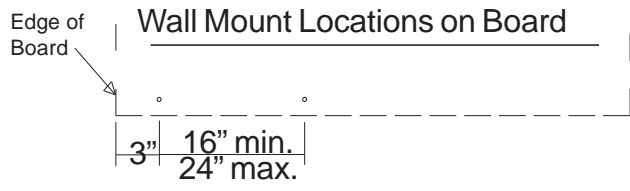

TYPE WALL

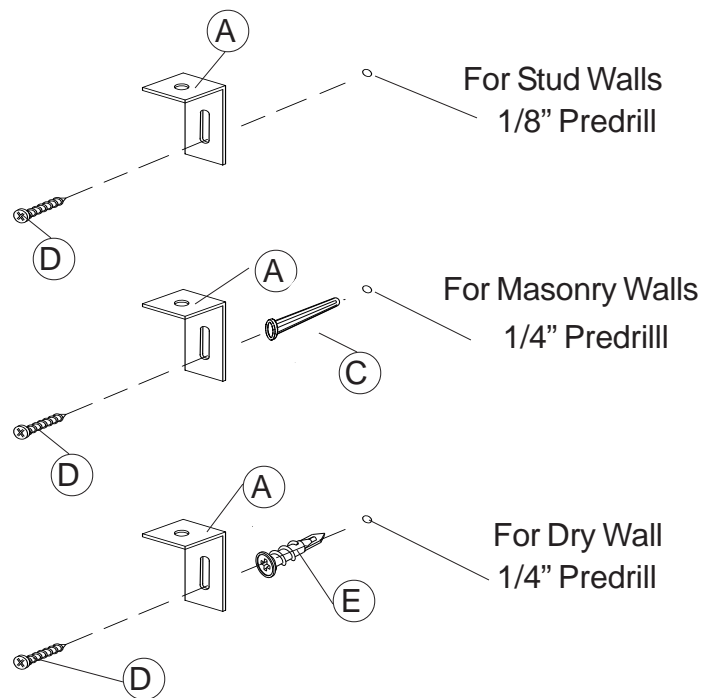

Preparing to Install Your New Glass Board

- 1.) Measure the length and width of your new board. Determine the wall center line and height off the floor that you want your new board to be located. Hold your board up in position and draw a line under the bottom of the board and parallel with the floor. If your wall has studs, determine the centerline of the studs. It is recommended that you tie into as many studs as possible when mounting your board.

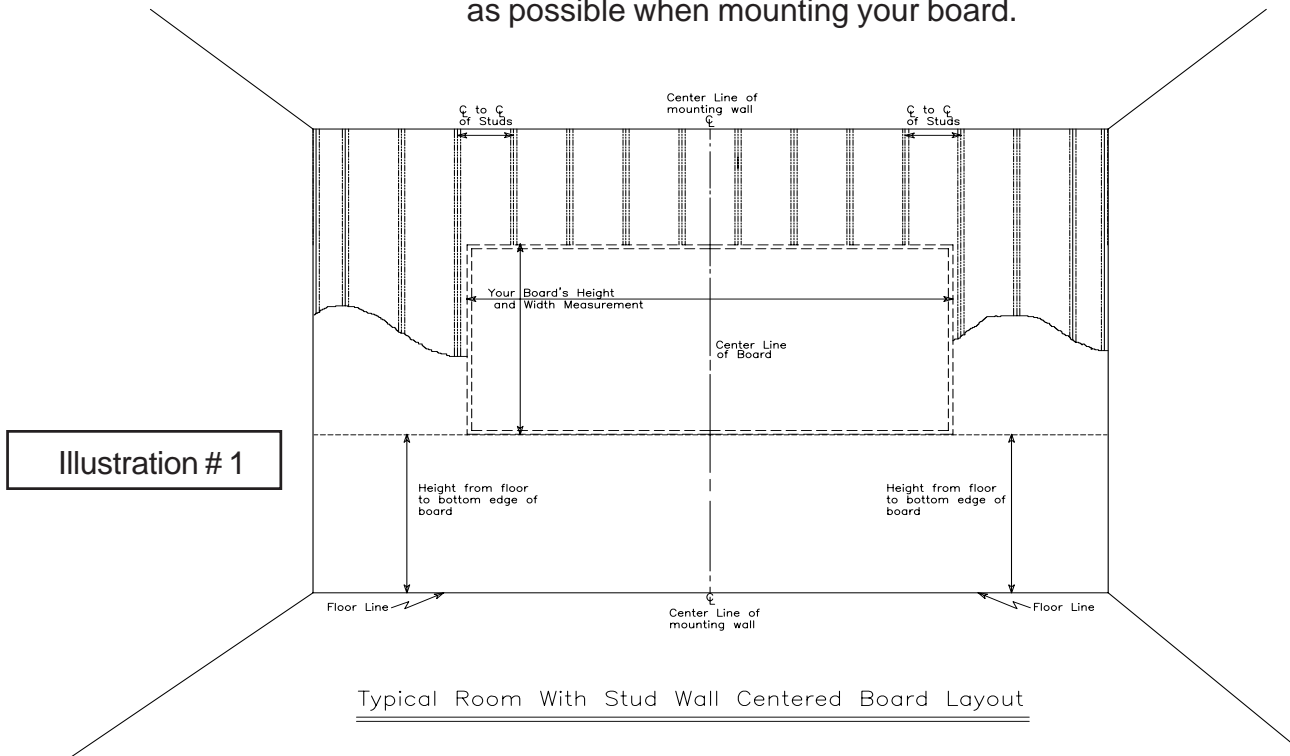

NOTE: The proper installation of your board will require at least two people.
 Tools required: Tape measure, chalkline, electric drill / screwdriver, drill and screwdriver bits, stud finder and level.

- 2.) Measure 1" up from your line and draw a second parallel line. You will need to drill 3/16" diameter holes in the back leg of the Tray extrusion for your mounting Screws (D). See Detail #2A for location. Follow the recommended hole locations, correct wall mount anchors and correct predrill for your type wall from Page 2. Attach Tray (P2) to the wall using the correct mounting hardware for your type wall.

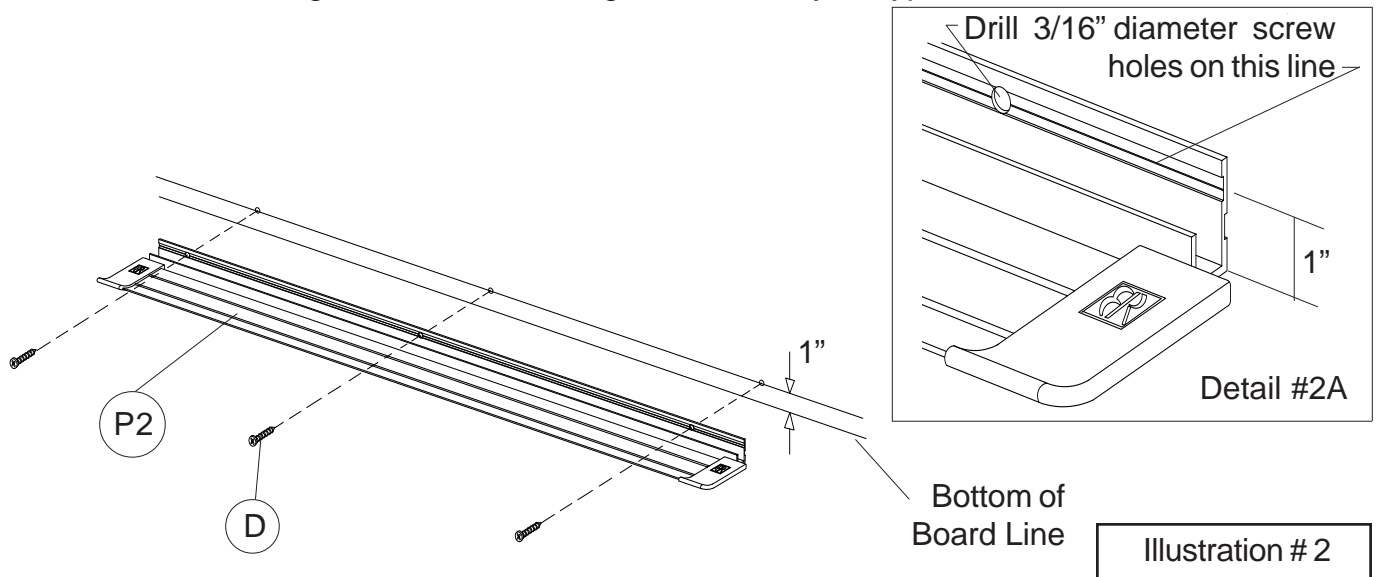
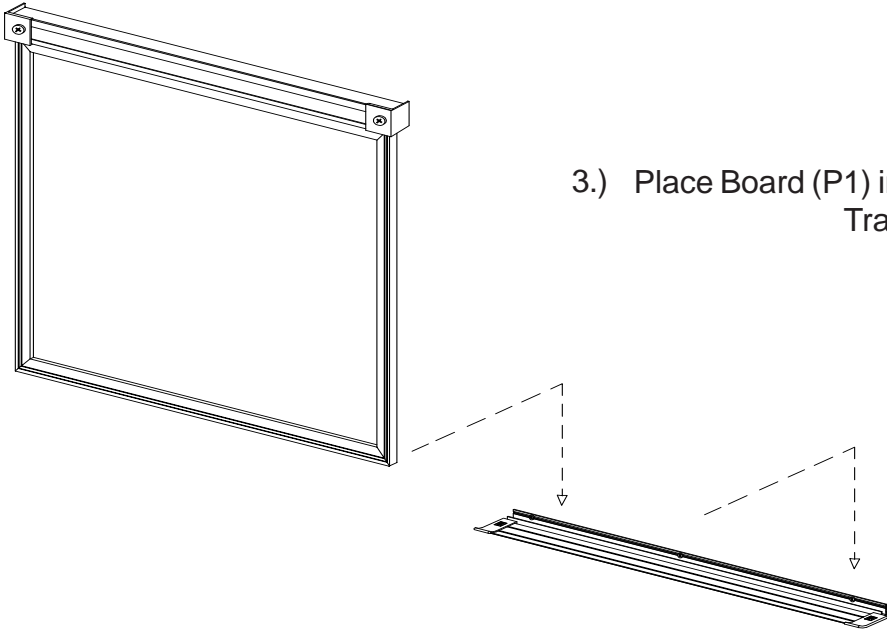
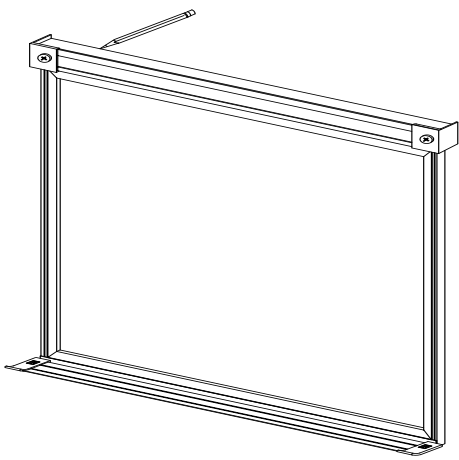

Illustration # 3



3.) Place Board (P1) into the wall mounted Tray (P2) board groove.



4.) Mark a line along the top edge of the board.

Illustration # 4

5.) Draw a line 1" down from the top line. Install the L-Clips (A) using the recommended mount spacing and the correct hardware for your type wall.

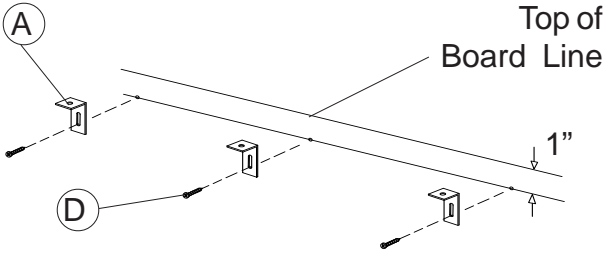
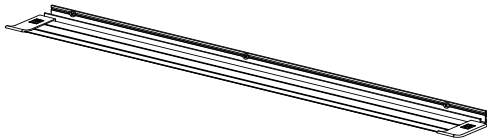

Illustration # 5



6. Make sure your L-Clips (A) are pushed up. Place the Glass Board (P1) back into the board groove in the Tray (P2). Push the L-Clips down and secure to the top of the board using Self Drilling Screws (B) as shown in illustration #6.

