

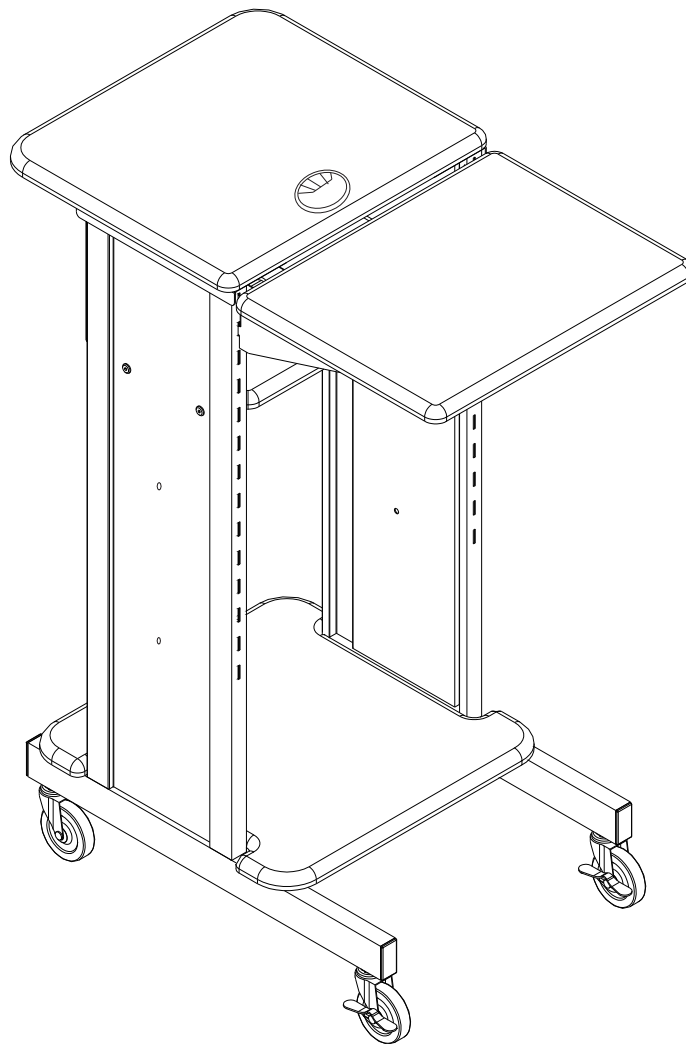

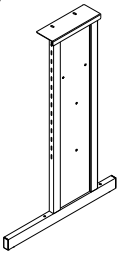







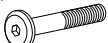







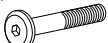





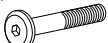

# Presentation Cart

AV Cart w/Adjustable Height Shelves

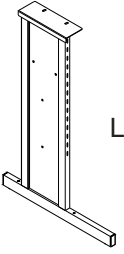
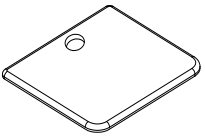
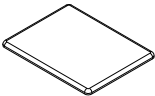
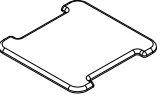
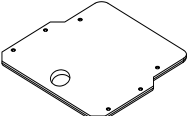
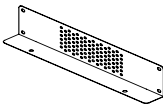
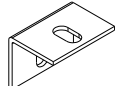
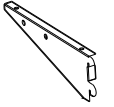

## Assembly Instructions

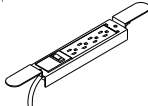
Part Drawing	Description	Qty	Part Drawing	Description	Qty																																
P1	 Leg Assembly Right	1 EA	<div style="text-align: center; border: 1px solid black; border-radius: 10px; padding: 10px;"> <h3>Hardware List</h3> <table border="0"> <tr> <td>A</td> <td></td> <td>9/16"Socket Screw</td> <td>22 EA</td> </tr> <tr> <td>B</td> <td></td> <td>2-1/2" Socket Screw</td> <td>4 EA</td> </tr> <tr> <td>C</td> <td></td> <td>Square Nut</td> <td>4 EA</td> </tr> <tr> <td>D1</td> <td></td> <td>3" Locking Caster</td> <td>2 EA</td> </tr> <tr> <td>D2</td> <td></td> <td>3" Caster</td> <td>2 EA</td> </tr> <tr> <td>E</td> <td></td> <td>Plastic Grommet</td> <td>2 EA</td> </tr> <tr> <td>F</td> <td></td> <td>Allen Wrench</td> <td>1 EA</td> </tr> <tr> <td>G</td> <td></td> <td>Caster Wrench</td> <td>1 EA</td> </tr> </table> </div>			A		9/16"Socket Screw	22 EA	B		2-1/2" Socket Screw	4 EA	C		Square Nut	4 EA	D1		3" Locking Caster	2 EA	D2		3" Caster	2 EA	E		Plastic Grommet	2 EA	F		Allen Wrench	1 EA	G		Caster Wrench	1 EA
A		9/16"Socket Screw				22 EA																															
B		2-1/2" Socket Screw				4 EA																															
C		Square Nut				4 EA																															
D1		3" Locking Caster				2 EA																															
D2		3" Caster				2 EA																															
E		Plastic Grommet				2 EA																															
F		Allen Wrench				1 EA																															
G		Caster Wrench				1 EA																															
P2	 Leg Assembly Left	1 EA																																			
P3	 LCD Platform	1 EA																																			
P4	 Laptop Shelf	1 EA																																			
P5	 Lower Shelf	1 EA																																			
P6	 Middle Shelf	1 EA																																			
P7	 Stability Panel	1 EA																																			
P8	 Angle Bracket	4 EA																																			
P-9	 Right Shelf Bracket	1 EA																																			
P-10	 Left Shelf Bracket	1 EA																																			
			 Optional Electrical Outlet 1 EA W/Cord Winder <b>(NOT INCLUDED)</b>																																		

# Assembly Diagram

**READ THROUGH INSTRUCTIONS FROM BEGINNING TO END BEFORE STARTING TO ASSEMBLE UNIT.**

- 1.) Identify and Separate all the Parts and Hardware.
- 2.) Place the LCD Platform (P-3) with the insert nuts facing up. Attach 1 Right Leg Assembly (P-1) and 1 Left Leg Assembly (P-2) using 4 each (A) screws.  
*(Finger tighten only)*

- 3.) Attach Stability Panel (P-7) to Right & Left Leg Assemblies (P-1 & P-2) using 4 (A) Screws as shown in illustration #1.  
*(Finger tighten only)*

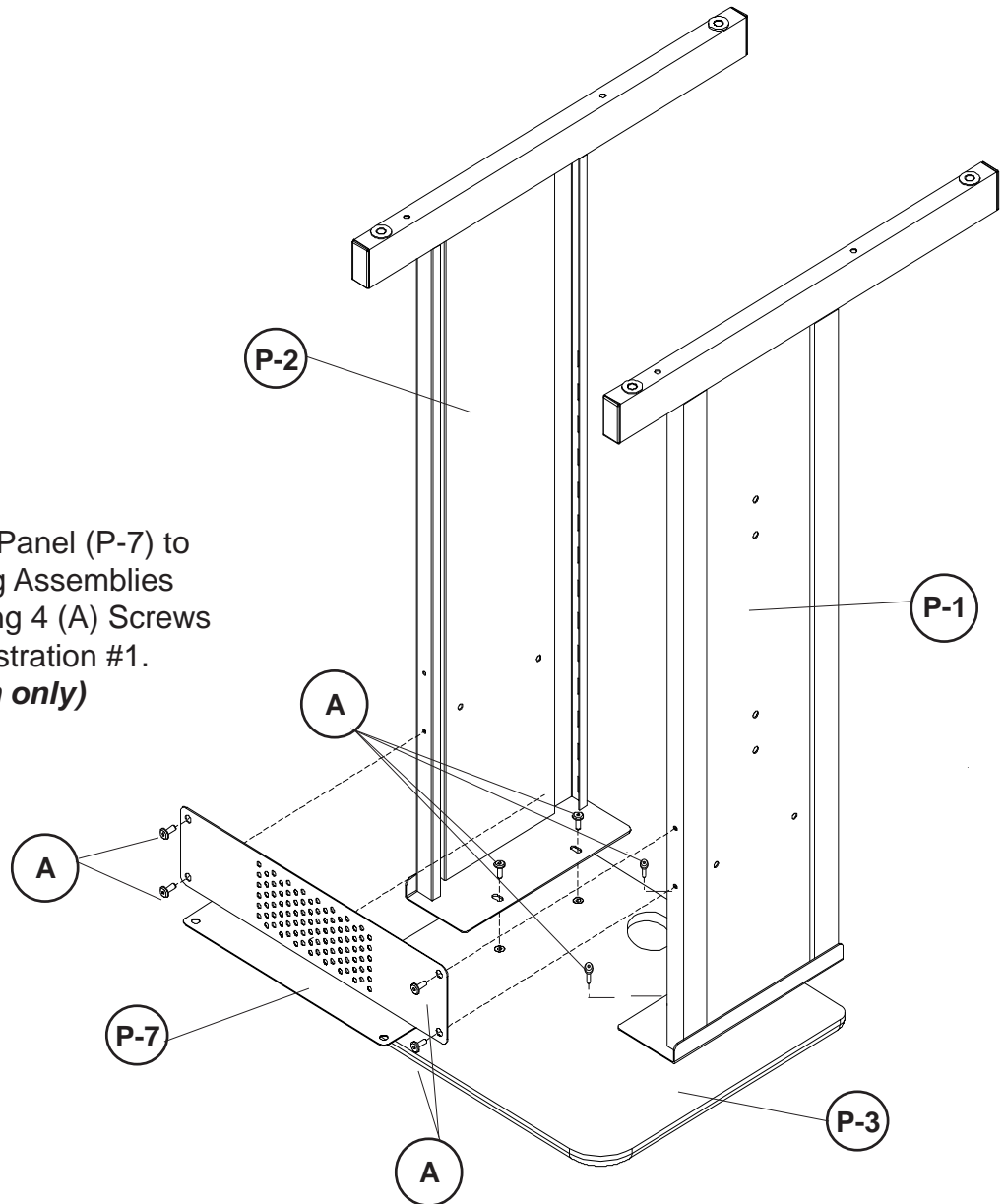
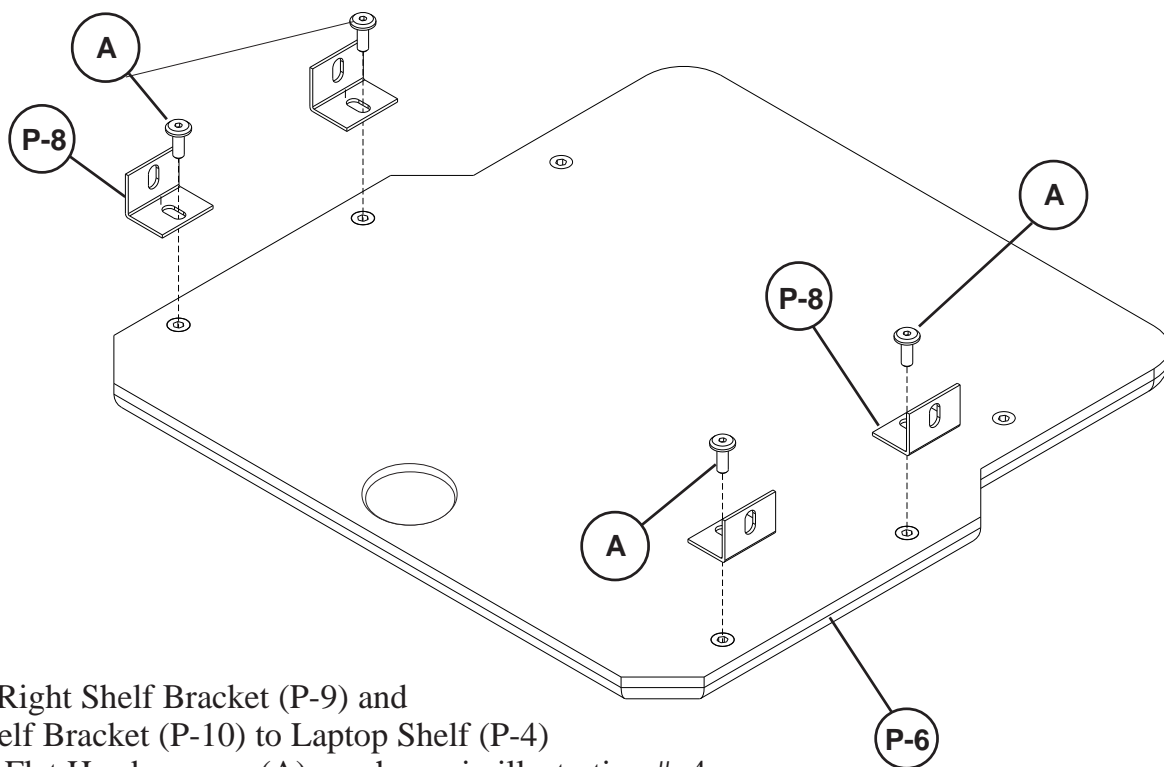

Illustration # 1

4.) Align 4 each Angle Brackets (P-8) with the edge of the Middle Shelf (P-6) and attach using 4 each (A) Screws as shown in illustration #2. (**Finger tighten only**)

Illustration # 2



5.) Attach Right Shelf Bracket (P-9) and Left Shelf Bracket (P-10) to Laptop Shelf (P-4) using 4 Flat Head screws (A) as shown in illustration # 4. (**Finger tighten only**)

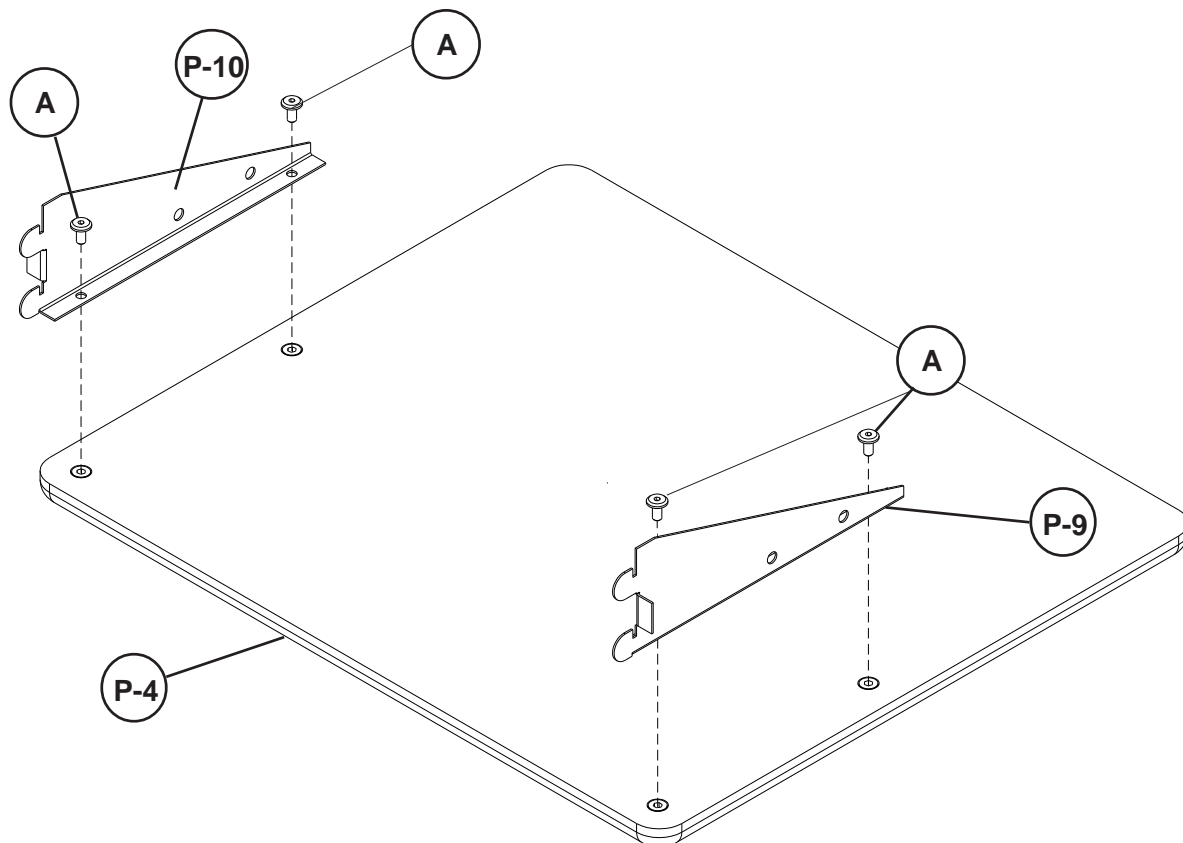
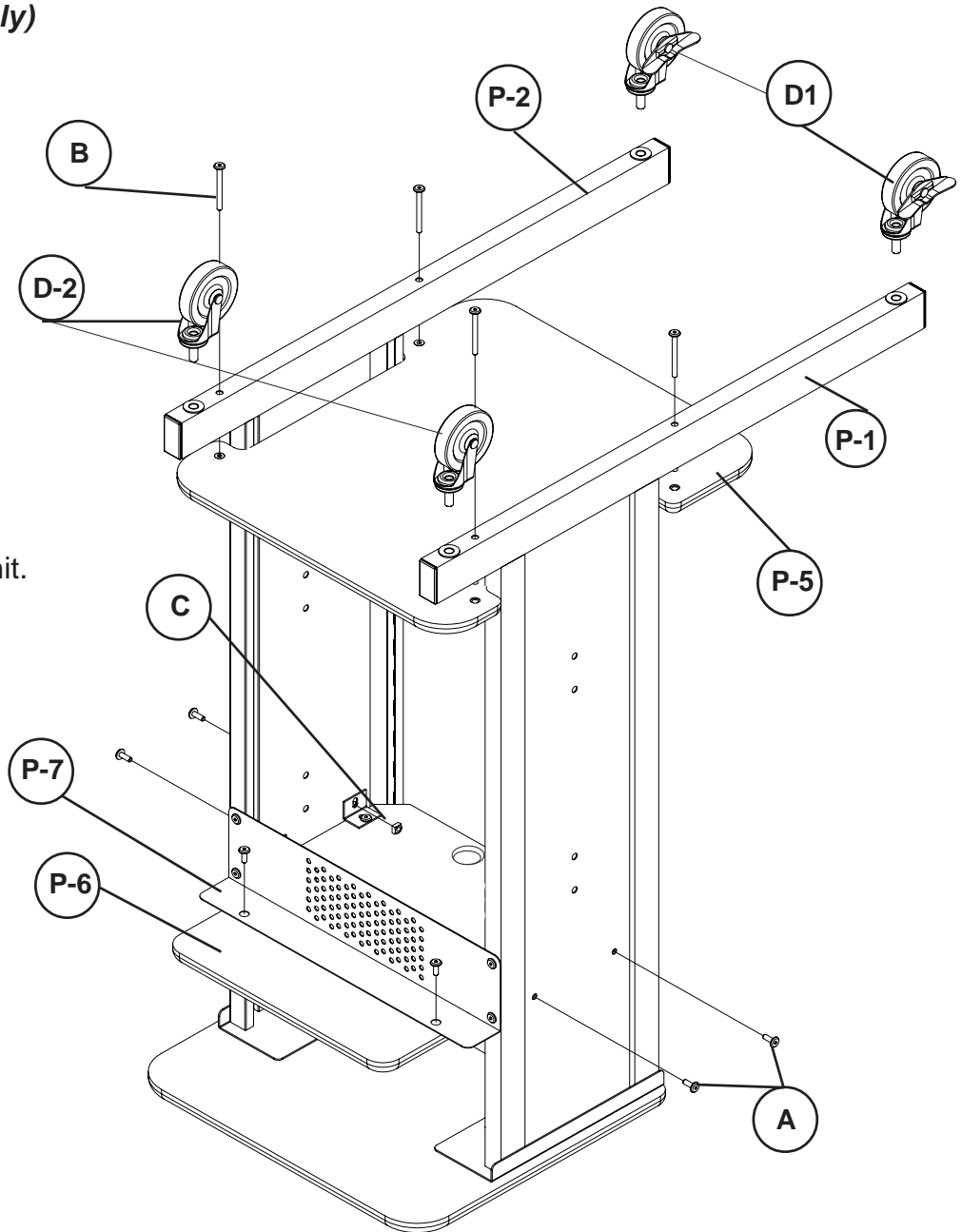

Illustration # 3

- 6.) Attach Lower Shelf (P-5) to the Right & Left Leg Assemblies (P1 & P2) using 4 each (B) screws as shown in illustration # 4.  
**(Finger tighten only)**



- 7.) Attach 2 Locking Casters (D-1) to the front of the unit. Attach 2 Casters (D-2) to the back of the unit. Tighten all Casters using Caster Wrench (G).

- 8.) Slide Middle Shelf (P-6) Between Right & Left Leg Assemblies (P-1 & P-2) and attach Middle Shelf (P-6) using 4 each (A) screws and 4 each (C) Square Nuts as shown in illustration # 4. Secure Middle Shelf (P-6) to Stability Panel (P-7) using two screws (A).

- 9.) *(Tighten all the screws at this time using Allen Wrench (F)).*

10.) To install Grommets (E) in LCD Platform (P-3) and Middle Shelf (P-6), separate parts and press Grommet Sleeve in opening as shown in illustration # 5.

11.) Snap a plastic Cap into the top of each Sleeve as shown in illustration # 5.

12.) Hook the Right Shelf Bracket (P-9) and Left Shelf Bracket (P-10) into the Right & Left Leg Assemblies at the desired height as shown in illustration # 5.

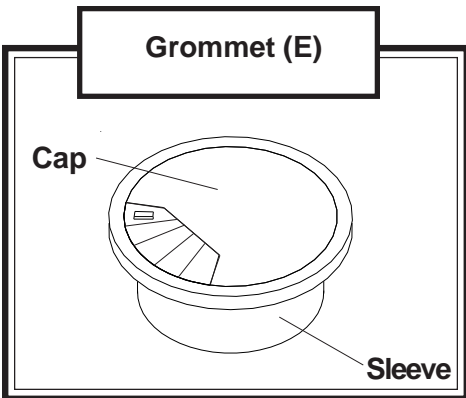
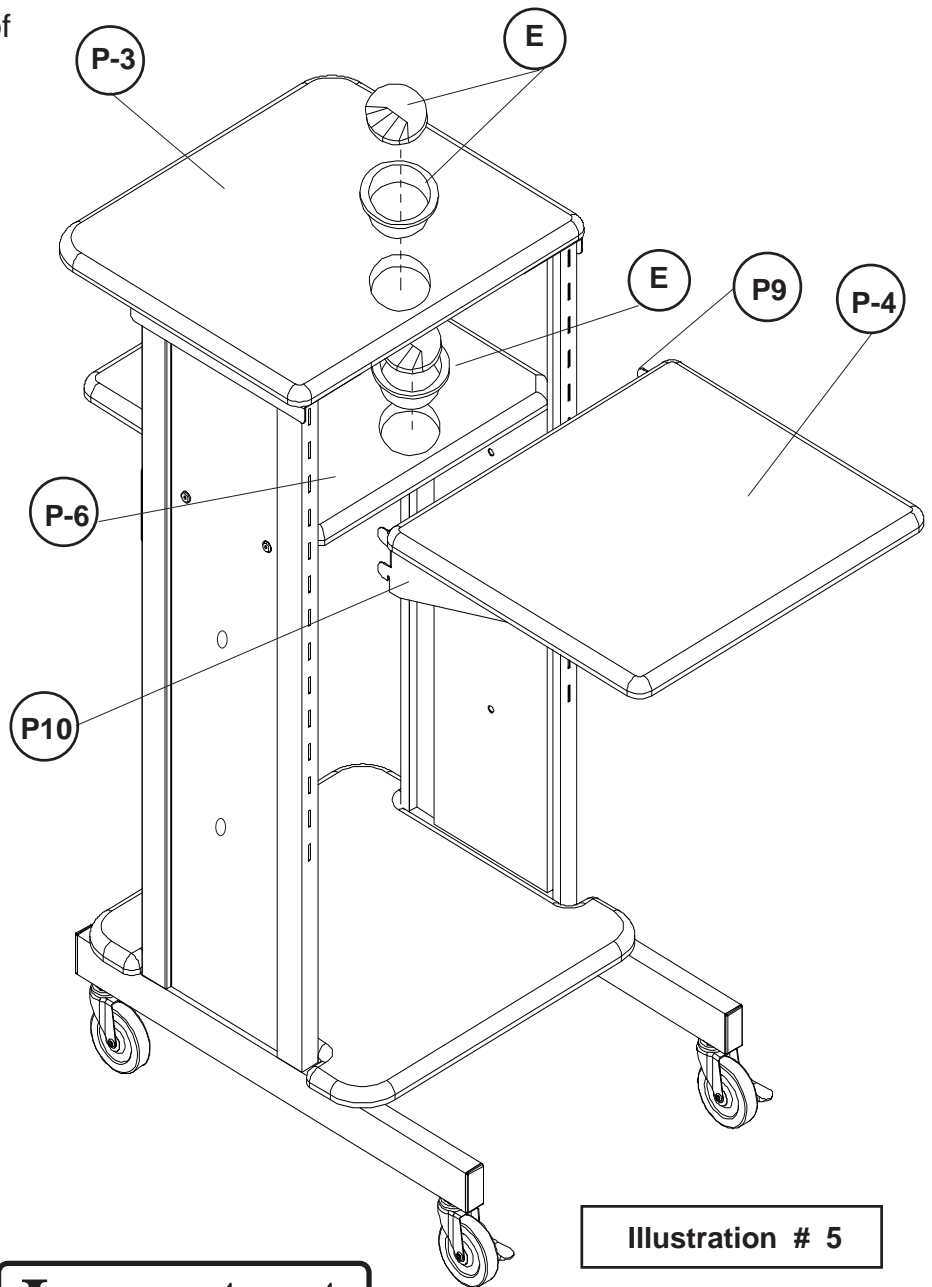

Illustration # 5

## Important



The product you have purchased is guaranteed against material and workmanship defects. This guarantee extends 1 year from date of purchase. Should this product fail to function satisfactorily under normal use due to defect or imperfection, the defective part or product will be replaced. Damage caused by common carriers during shipment is not included in this guarantee.

**This guarantee sets forth all applicable guarantees and remedies. No other warranty, expressed or implied shall apply. Failure to follow instructions found in Important Information Section of Owner Sheet shall void the guarantee. Consequential or incidental damages and or costs are not refundable.**

# Optional Electric Outlet Assembly Diagram

(NOT INCLUDED)

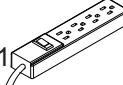
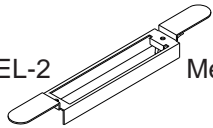
## Parts/Hardware List

EL-1		Electric Outlet	1 EA
EL-2		Metal Bracket w/Cord Winder	1 EA
EL-3		Phillips Head Screw	2 EA
EL-4		Hex Nut	2 EA

- 1.) Identify and Separate all the Parts and Hardware.
- 2.) Slide Metal Bracket over the Electrical Outlet (EL-1) as shown. (note that Metal Stop is at the end with the electrical Plug-in.)
- 3.) Attach Metal Bracket (EL-2) to the Right or Left Leg Assembly (P-1 or P-2) using 2 Phillips Head Screws (EL-3) and 2 Hex Nuts (EL-4) as shown in Optional Electrical illustration.

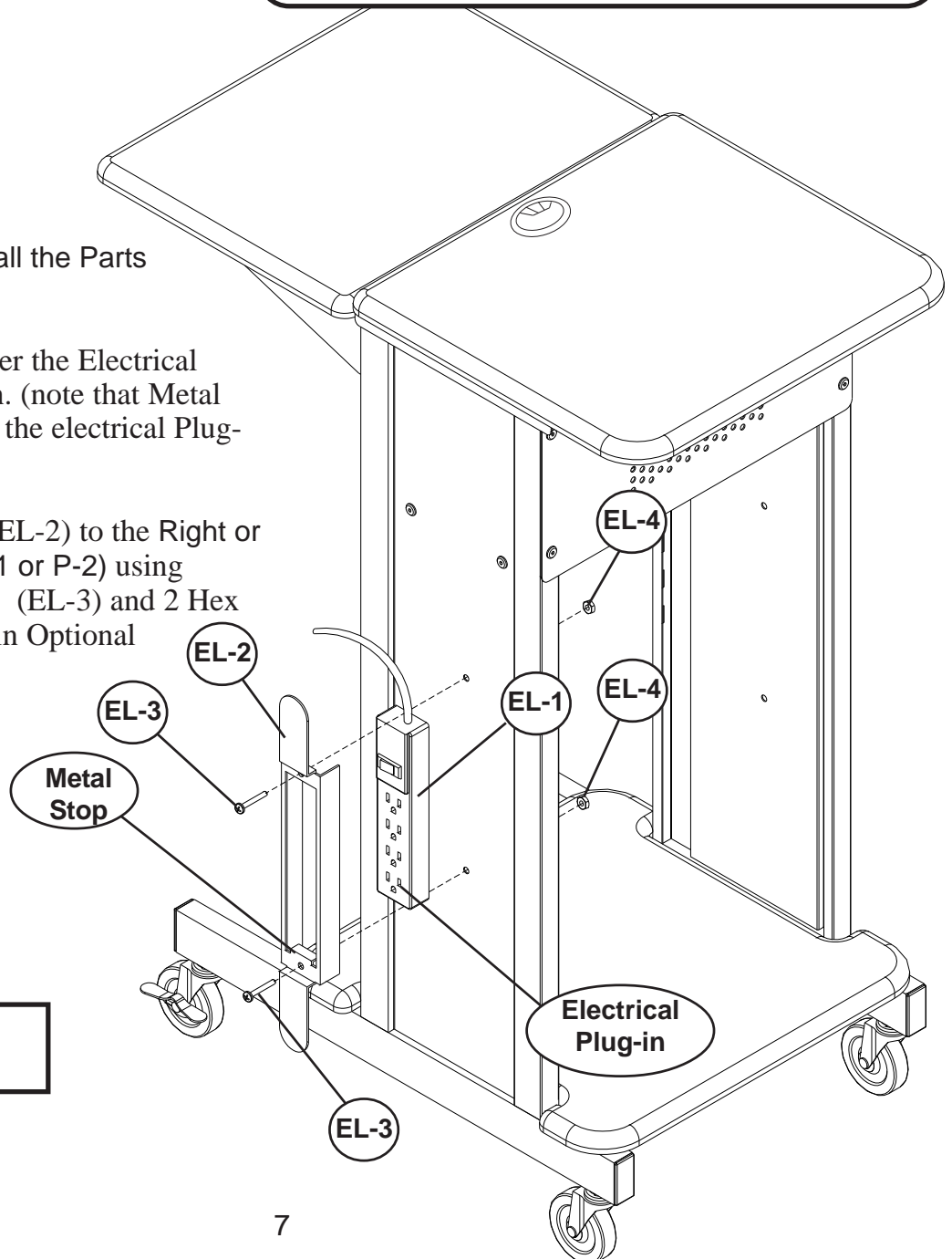

Optional Electrical  
Illustration

# Presentation Cart

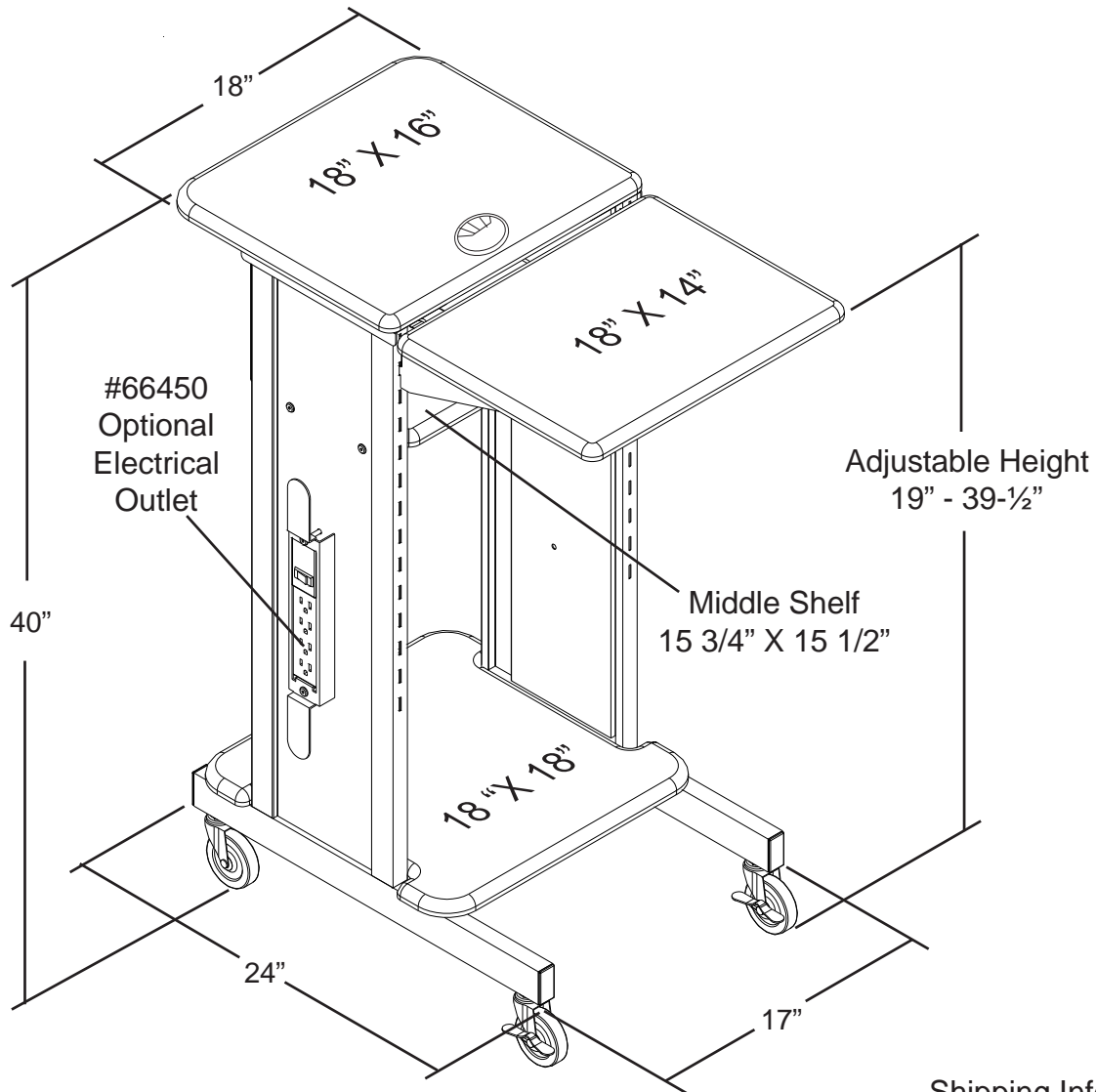

Shipping Information  
2.86 Cubic Feet  
49 lbs.

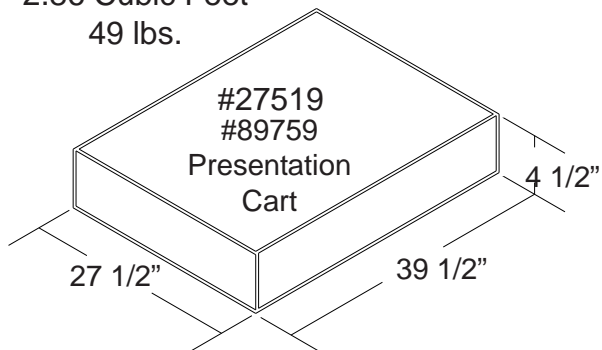

Shipping Information  
0.2 Cubic Feet  
4.0 lbs.

