

# ***Balt Wide Body Flat Panel TV Cart - 27553***

Instruction Manual



*Provided by*

**MyBinding.com**  
*When Image Matters.*

Call Us at 1-800-944-4573



# #27553 Wide Body LCD TV Cart

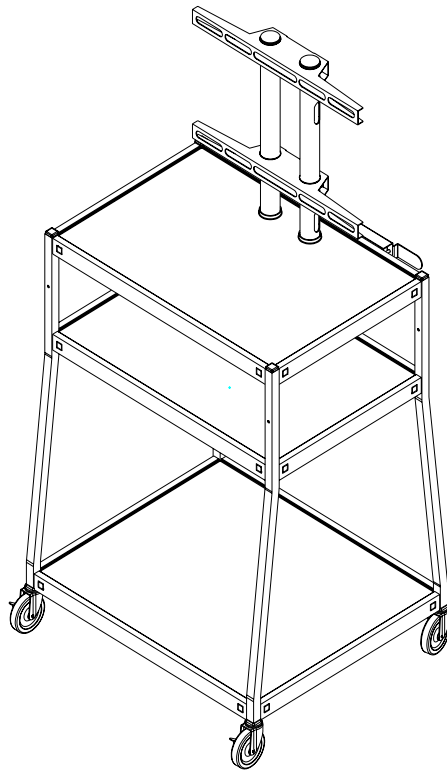







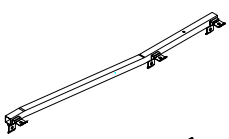
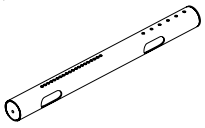
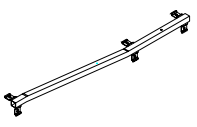
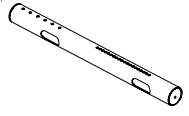
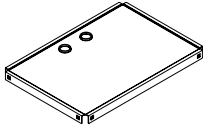
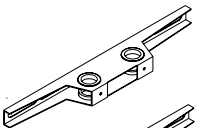
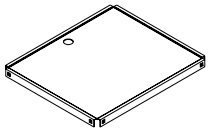
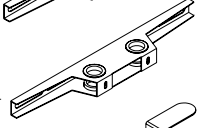
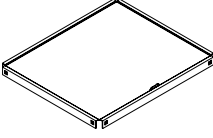
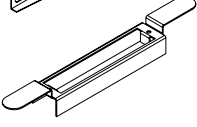
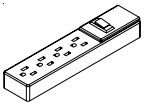

SUPPORTS UP TO A 44" FLAT PANEL TV

## Assembly Instructions

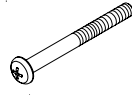
# #27553 Wide Body LCD Cart

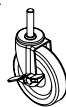
Part	Drawing	Description	Qty	Part	Drawing	Description	Qty
P1		Formed Leg "O"	2 EA	P6		Left Support Tubes	1 EA
P2		Formed Leg "X"	2 EA	P7		Right Support Tubes	1 EA
P3		Top Shelf	1 EA	P8		Top LCD Bracket	1 EA
P4		Middle Shelf	1 EA	P9		Bottom LCD Bracket	1 EA
P5		Bottom Shelf	1 EA	P10		Cord Winder w/Verticle Slots	1 EA
				P11		Electrical Outlet	1 EA

## Hardware List

A1		Sq Hd Screw M8x15mm	24 EA	B1		Hex nut M8 w/Flange	24 EA
A2		Screw M5X70mm Pan Hd electrical	2 EA	B2		Hex nut M5 w/Flange electrical	2 EA
A3		Screw M8X20mm SocketHd installed in end of monitor tubes	2 EA	C		4" Locking Caster	2 EA
A4		Screw M8X25mm Dog Point back of monitor tube-Top	2 EA	D		4" Caster	2 EA
A5		Screw M8X25mm Cone Point back of monitor tube-Bottom	2 EA				

Do not use unless all screws are tight. At least every six months, check all screws to be sure they are tight. If parts are missing, broken, damaged, or worn, stop use of the product until repairs are made by your dealer using factory authorized parts.

# #27553 Wide Body LCD Cart

**READ THROUGH INSTRUCTIONS FROM BEGINNING TO END BEFORE STARTING TO ASSEMBLE UNIT.**

**Illustration # 1**

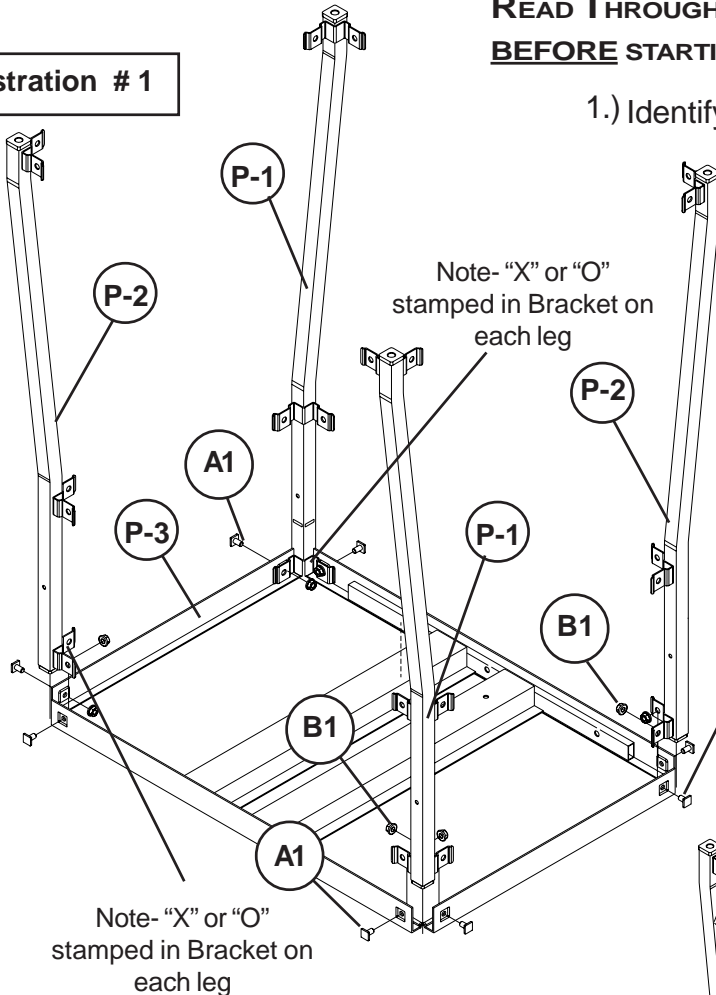

1.) Identify and Separate all the Parts and Hardware.

2.) Attach 2 Legs (P-1) and 2 Legs (P-2) to the Top Shelf (P-3) using 8 screws (A1), and 8 Nuts (B1) as shown in illustrations #1.

3.) Slide Middle Shelf (P-4) in between the 4 Legs (P1 & P-2) and attach using 8 screws (A1), and 8 Nuts (B1) as shown in illustration # 2.

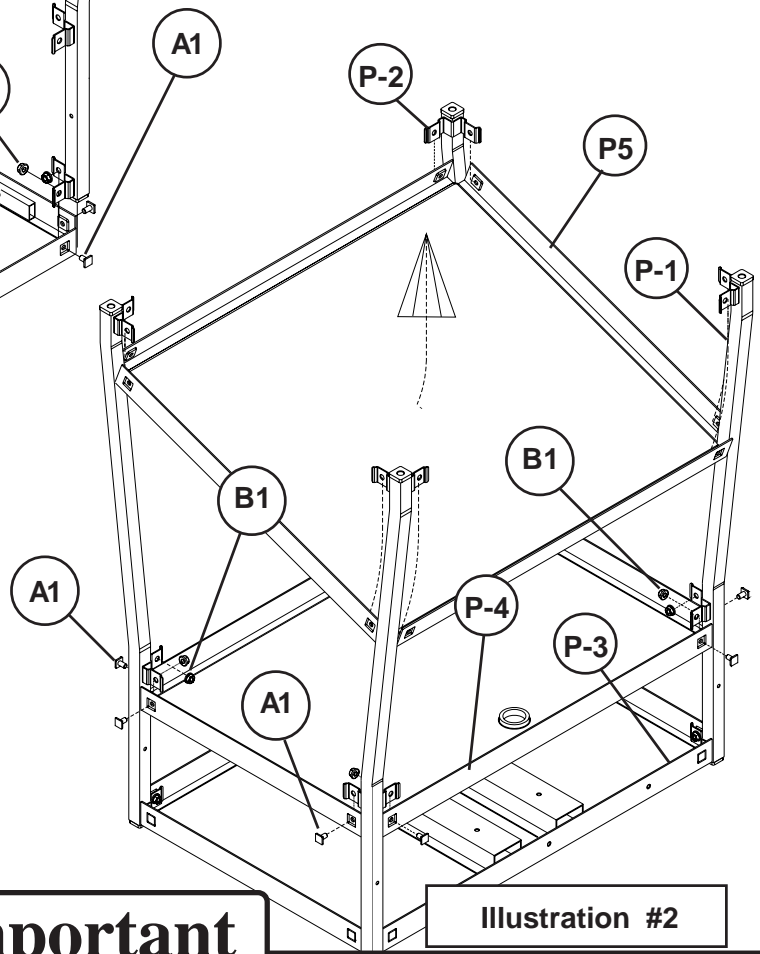

**Illustration #2**

4.) Slide Bottom Shelf (P-5) in between the 4 Legs (P1 & P-2) as shown in illustration #2.



## Important

The Balt product you have purchased is guaranteed against material and workmanship defects. This guarantee extends 1 year from date of purchase. Should this product fail to function satisfactorily under normal use due to defect or imperfection, the defective part or product will be replaced. Damage caused by common carriers during shipment is not included in this guarantee.

**This guarantee sets forth all applicable guarantees and remedies. No other warranty, expressed or implied shall apply. Failure to follow instructions found in Important Information Section of Owner Sheet shall void the guarantee. Consequential or incidental damages and or costs are not refundable.**

**Note:** Be sure that grommet in Middle Shelf (P4) is toward the back as shown in illustration # 3.

5.) Secure Bottom Shelf (P-5) to the 4 Legs (P-1 & P-2) using 8 screws (A1) and 8 Nuts (B1) as shown in illustration # 4.

6.) Press 2 Locking Casters (C) and 2 non-locking casters (D) into the factory installed nylon inserts in the Legs (P-1 & P-2) as shown in illustration #4.

**Missing Parts or UPS Damaged Parts**  
For Your Convenience you can  
EMAIL us at  
**[furniture@baltinc.com](mailto:furniture@baltinc.com)**  
24HOURS 7 DAYS A WEEK

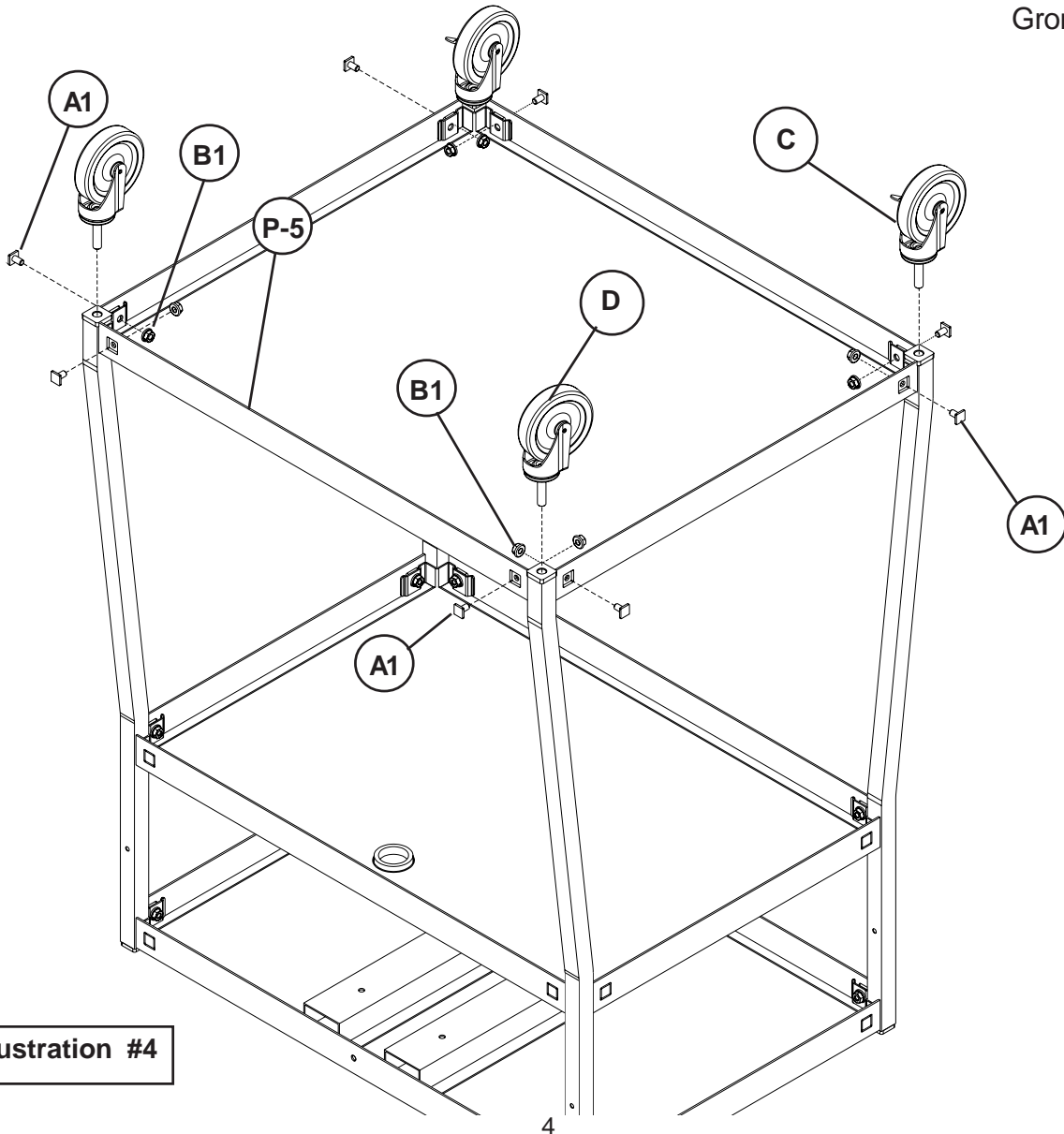
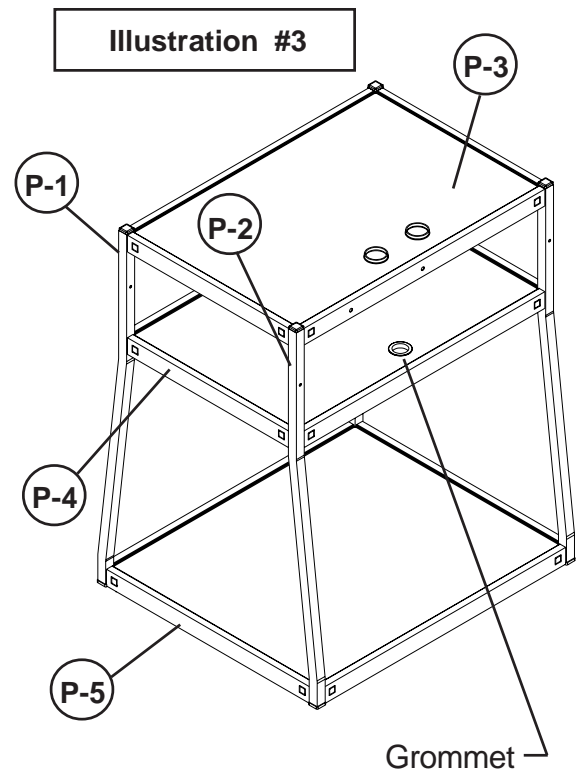

7.) Remove Screws (A3) from bottom of left and Right Support Tubes (P-6 & P-7) and attach to Top Shelf (P-3) as shown in illustration # 5.

8.) Attach Cord Winder (P-10) and Electrical Outlet (P-11) to Top Shelf (P-3) using 2 screws (A2) and 2 Nuts (B2).

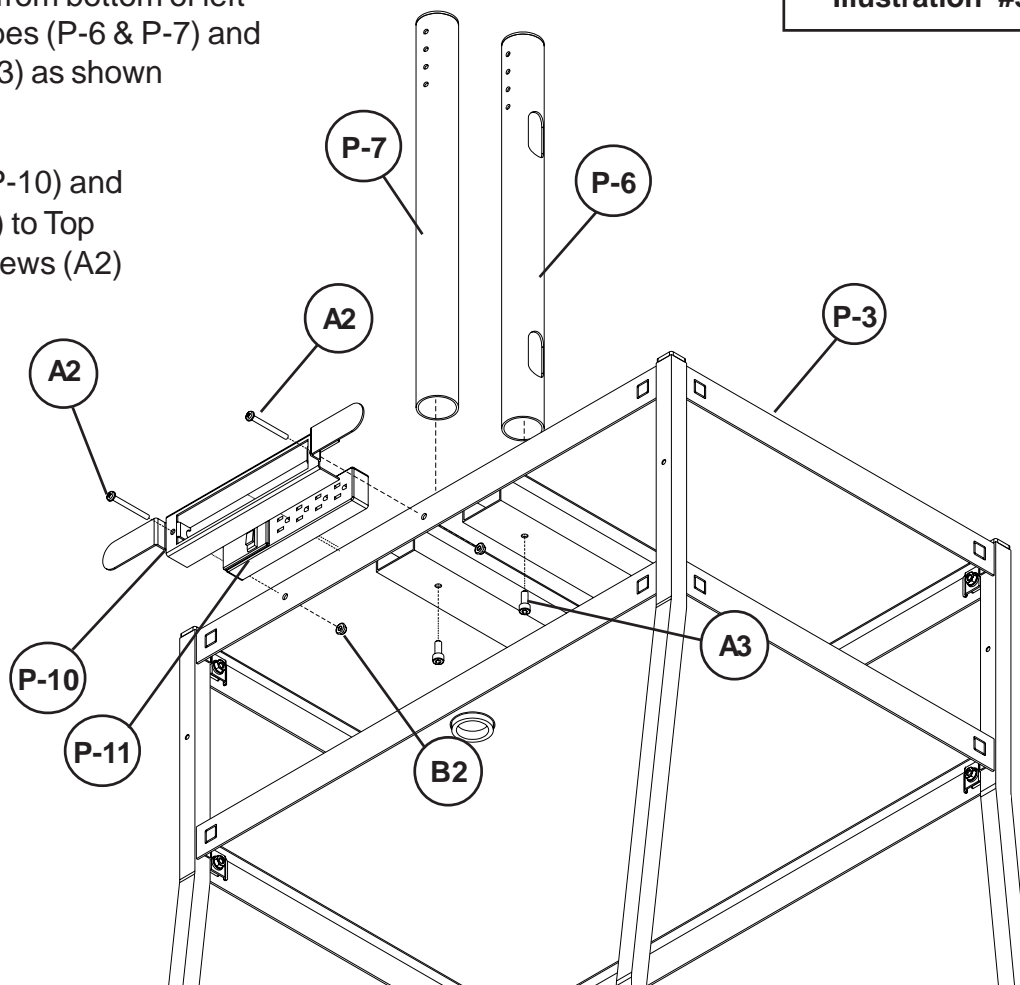

9.) Attach Bottom LCD Bracket (P-9) to Left and Right Support Tubes (P-6 & P-7) at desired height using 2 screws (A5).

10.) Attach Top LCD Bracket (P-8) to Left and Right Support Tubes (P-6 & P-7) at desired height using 2 screws (A4) as shown in illustration # 6.

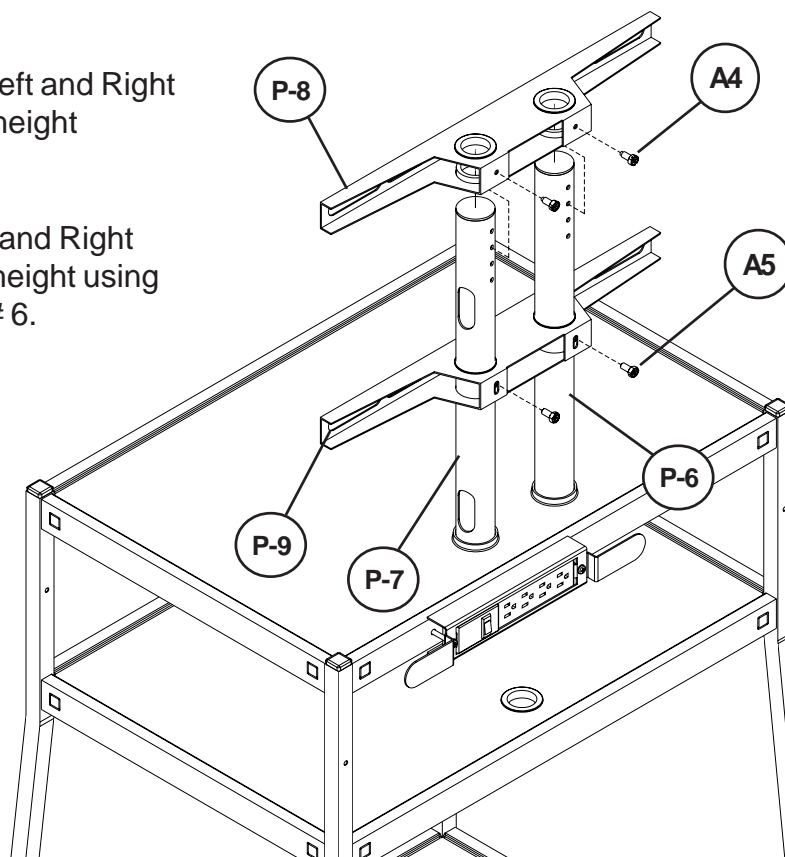

**Should you require assistance during assembly, please call our Customer Service Department Monday - Friday 8 a.m. - 5 p.m. Central Standard Time 1-800-749-2258**