

# ***Balt Economy Tablet Charging Cart - 27689***

Instruction Manual



*Provided by*

**MyBinding.com**  
*When Image Matters.*

Call Us at 1-800-944-4573





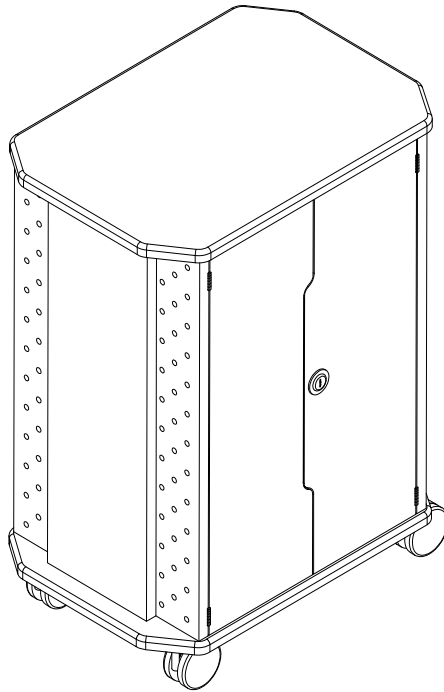





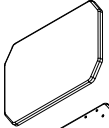
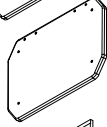



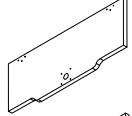
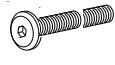
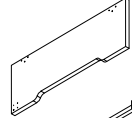
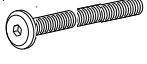
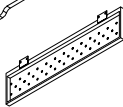

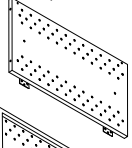

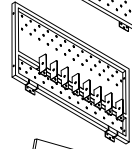

**27689**

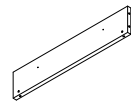
# **Economy Tablet Charging Cart**

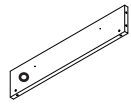





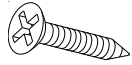

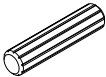

## **Assembly Instructions**

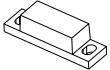
# #27689 Economy Tablet Charging Cart

Part	Drawing	Description	Qty	Part	Drawing	Description	Qty
P-1		Top Panel	1 EA	<b>Hardware List</b>			
P-2		Bottom Panel	1 EA	A		Screw 1/4" X 15mm	16 EA
P-3		Shelf	8 EA	A1		Screw 1/4" X 10mm	20 EA
P-4		Right Door	1 EA	B		Screw M6*32mm	8 EA
P-5		Left Door	1 EA	C		Screw 1/4" X 45mm	6 EA
P-6		Rear Door	1 EA	D		Electrical Clip Screw	4 EA
P-7		Left Metal Side	1 EA	E		3" Locking Caster	2 EA
P-8		Right Metal Side	1 EA	F		3" Non-Locking Caster	2 EA
P-10		Wood Side Panel	2 EA	G		Allen Wrench	1 EA
P-11		Right Back Panel	1 EA	H		Electrical Clip	4 EA
P-12		Left Back Panel	1 EA	J		Door Lock	1 EA
				K		Door Lock Bezel	1 EA
				L		Rear Door Lock	1 EA
				M		Rear Lock Clip	1 EA
				N		Door Latch	1 EA
				O		Door Latch Screw	4 EA
				P		Door Hinge Screws	20 EA

Part	Drawing	Description	Qty
------	---------	-------------	-----

Q		Wood Dowel	8 EA
R		Electrical Cord Holder	2 EA
S		Cord Holder Nut	4 EA
T		Door Magnet	2 EA
U		Magnet Screws	5 EA
V		Electrical Cord Grommet	1 EA
W		Plastic Spacer	4 EA
X		Electrical Wire Holder	16 EA
Y		Magnet Plate	1 EA

**(2) #58208-8 Outlet Electrical Strips**

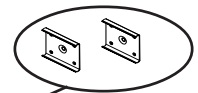
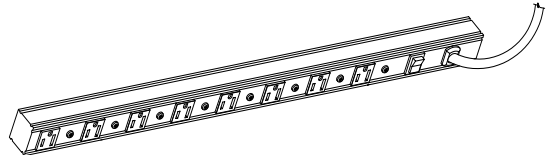

These parts are not used.

# Assembly Diagram

1. Identify and separate all parts.
2. Place the Top Panel (P-1) face down on a padded surface as shown in illustration #1. Connect the Right Metal Side (P-8) to the Top Panel (P-1) using two Screws (B) and going into the embedded threaded inserts in the bottom of the Top Panel. Attach the Left Metal Side (P-7) to the Top Panel using two Screws (B). Tighten Screws with Allen Wrench (G).

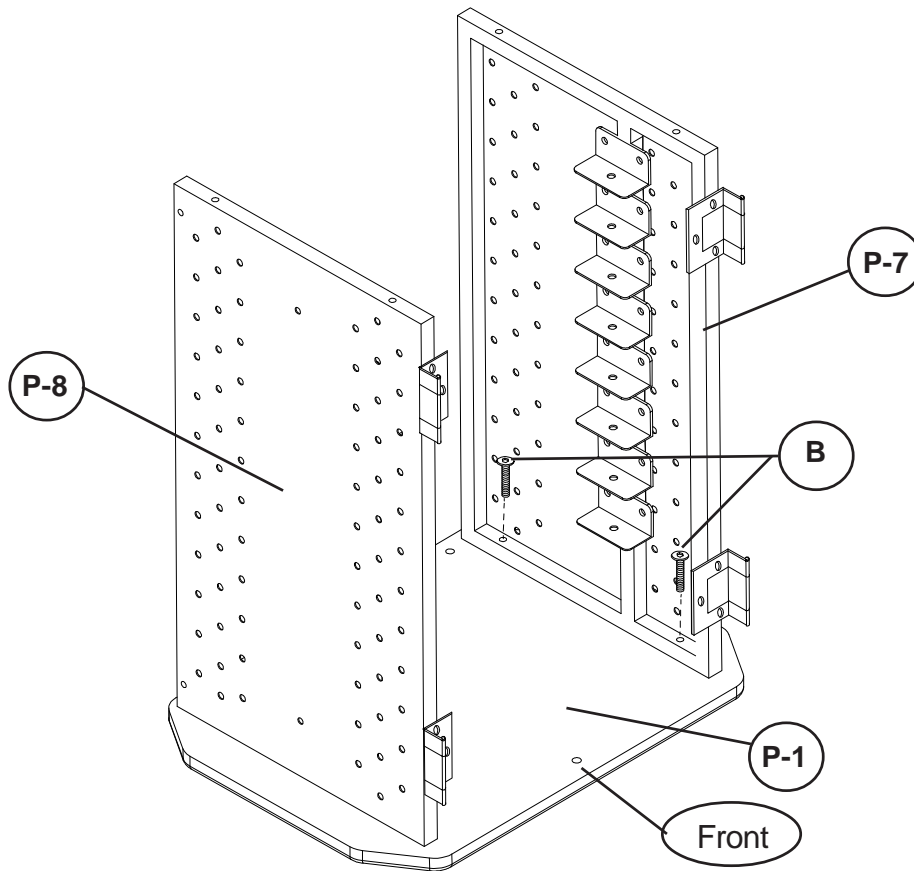

Illustration #1

3. Attach a Wood Side Panel (P-10) to the outside of each Metal Side using two Screws (A1) to secure each panel into place. See illustration # 2.

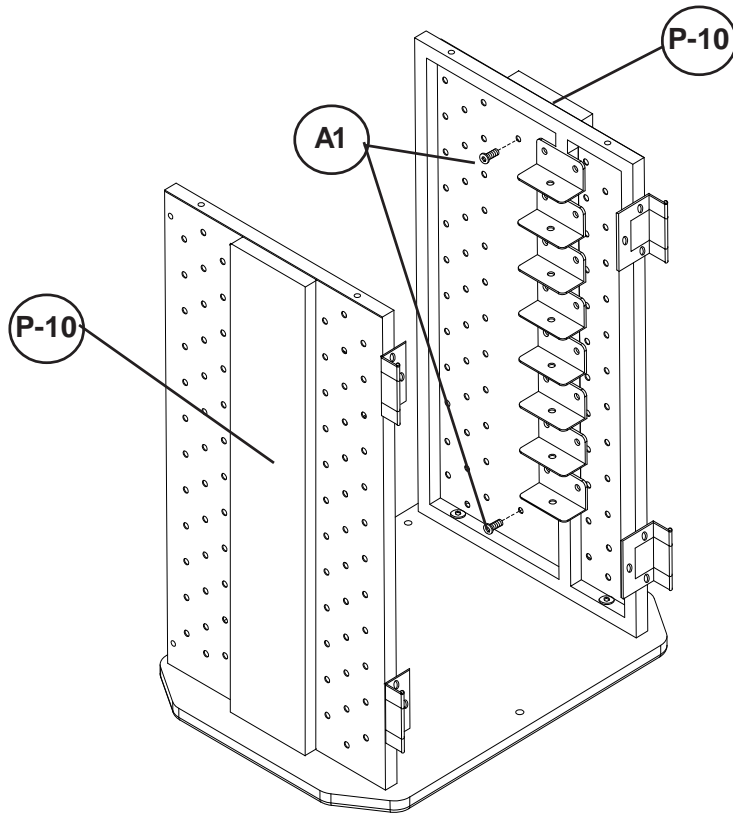

Illustration #2

4. Place a Shelf (P-3) on the shelf brackets of the Right and Left Metal Sides and secure in place using one Screw (A1) on each end as shown in illustration #3. Tighten with Allen Wrench (G). Repeat this Step to install the remaining 7 Shelves.

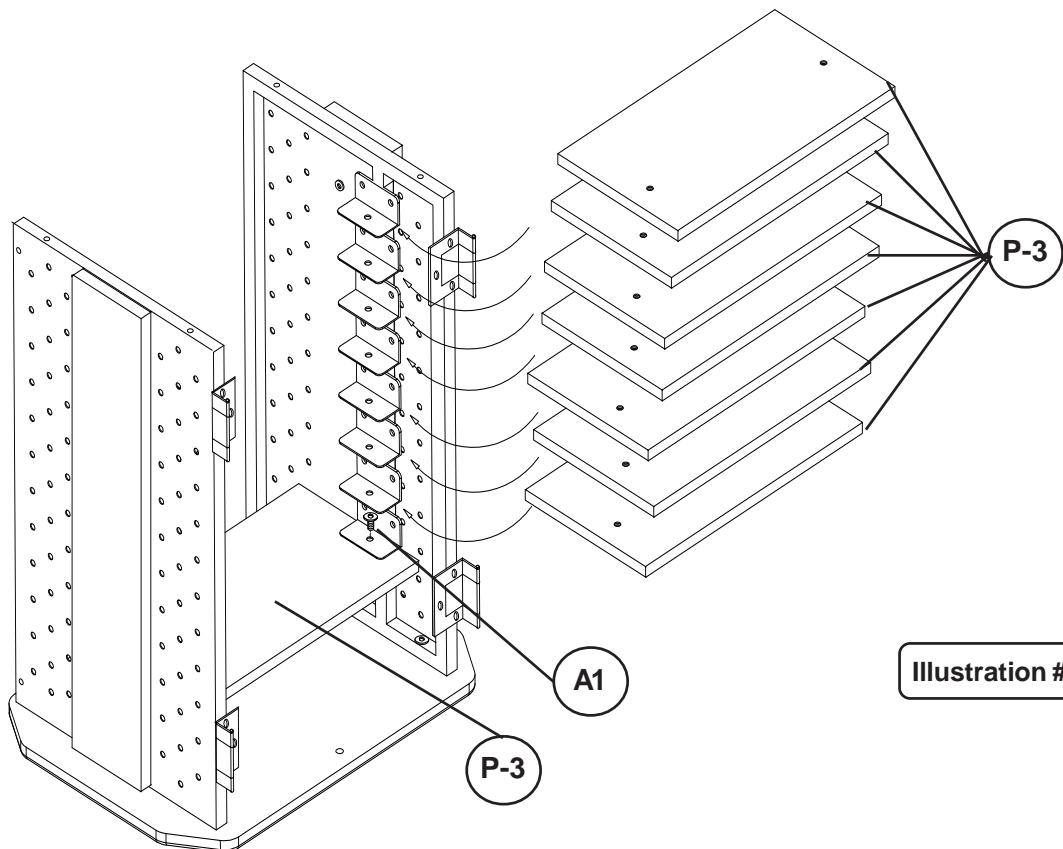
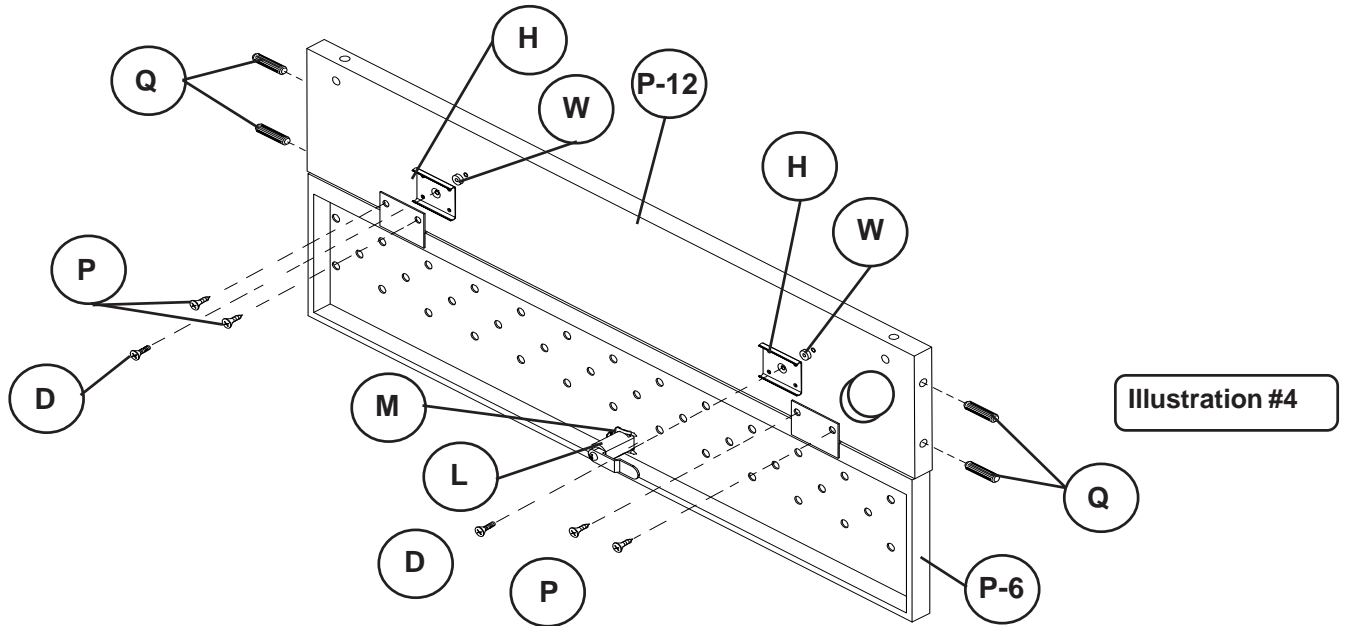
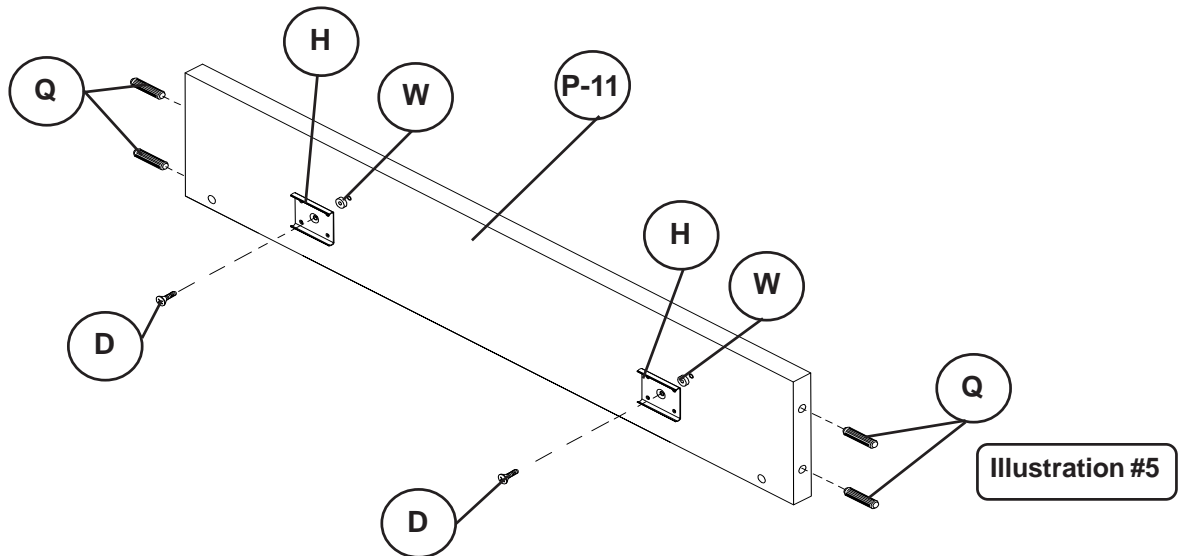

Illustration #3

5. Push in four Wood Dowels (Q) into the top edge and bottom edge predrilled holes of the Left Back Panel (P-12) as shown in illustration #4. Attach two Electrical Clips (H) to the inside of the Left Back Panel (P-12) using two Electrical Clip Screws(D) and two Plastic Spacers (W). Attach the Rear Door (P-6) to the Left Back Panel (P-12) using four Door Hinge Screws (P). Insert the Rear Door Lock (L) in from the front and use the Rear Lock Clip (M) as shown to secure in place.



6. Push in four Wood Dowels (Q) into the top edge and bottom edge predrilled holes of the Right Back Panel (P-11) as shown in illustration #5. Attach two Electrical Clips (H) to the inside of the Right Back Panel (P-11) using two Electrical Clip Screws(D) and two Plastic Spacers (W).



7. Place the Back Panel assemblies from Step 5 and Step 6 in between the Right and Left Side assemblies as shown in illustration #6. Make sure the Wood Dowels of the assemblies are insert into the predrilled holes in the bottom of the Top Panel (P-1). Secure the Back assemblies to each Side Panel assembly using three Screws (C). Tighten Screws with Allen Wrench (G). Attach the Magnet (T) to the bottom of the Top Panel (P-1) using two Magnet Screws (U) into the predrilled holes so the Rear Door (P-6) stops against the Magnet. See Detail 7A.

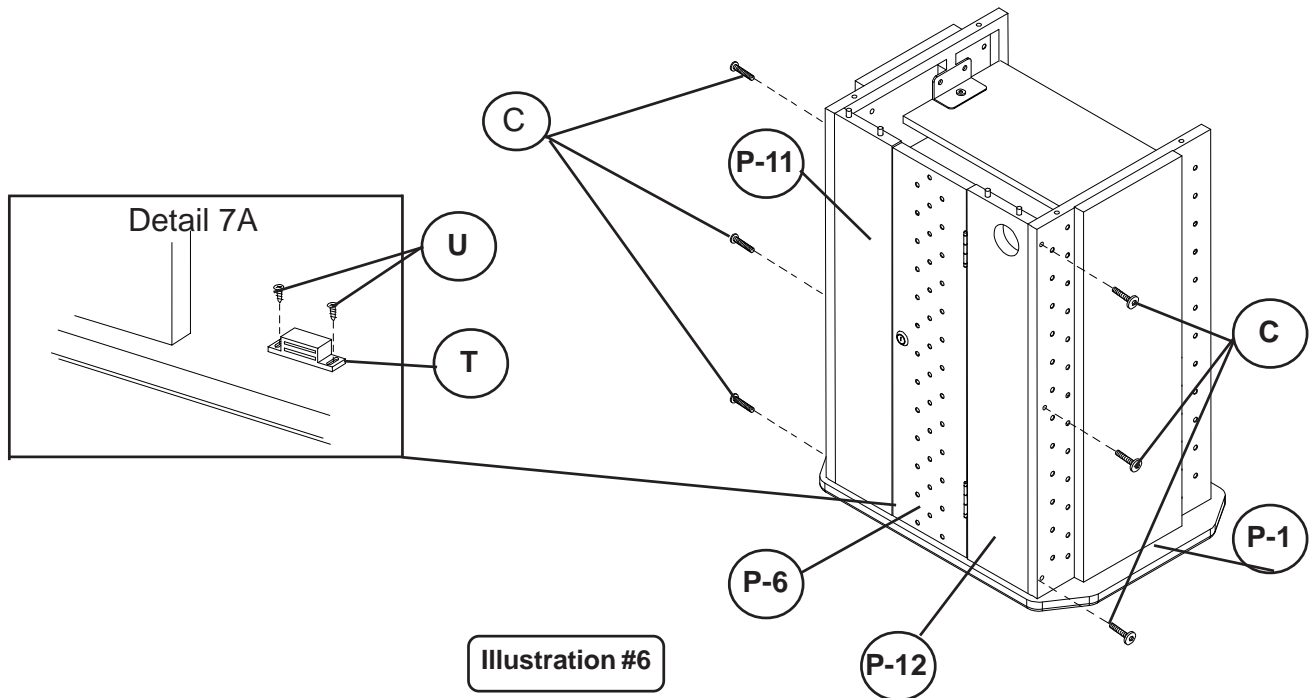

8. To attach the Bottom Panel (P-2) to the assembly from Step 7, line up the Wood Dowels in the Back assemblies with the predrilled holes in the Bottom Panel (P-2). Attach the Bottom Panel (P-2) to the Side assemblies using four Screws (B) as shown in illustration #7. Tighten Screws with Allen Wrench (G).

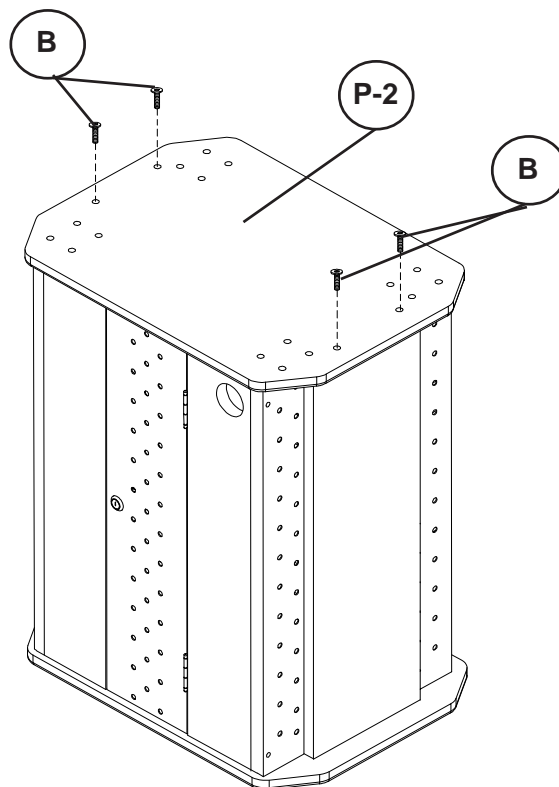



9. Attach two Locking Casters (E) in the front embedded insert holes of the Bottom Panel (P-2) using eight Screws (A) as shown in illustration #8. Attach two Non-Locking Casters (F) in the rear embedded insert holes of the Bottom Panel using eight Screws (A). Tighten Screws with Allen Wrench (G). Press in the Electrical Grommet (V) in the Left Back Panel's cut-out.

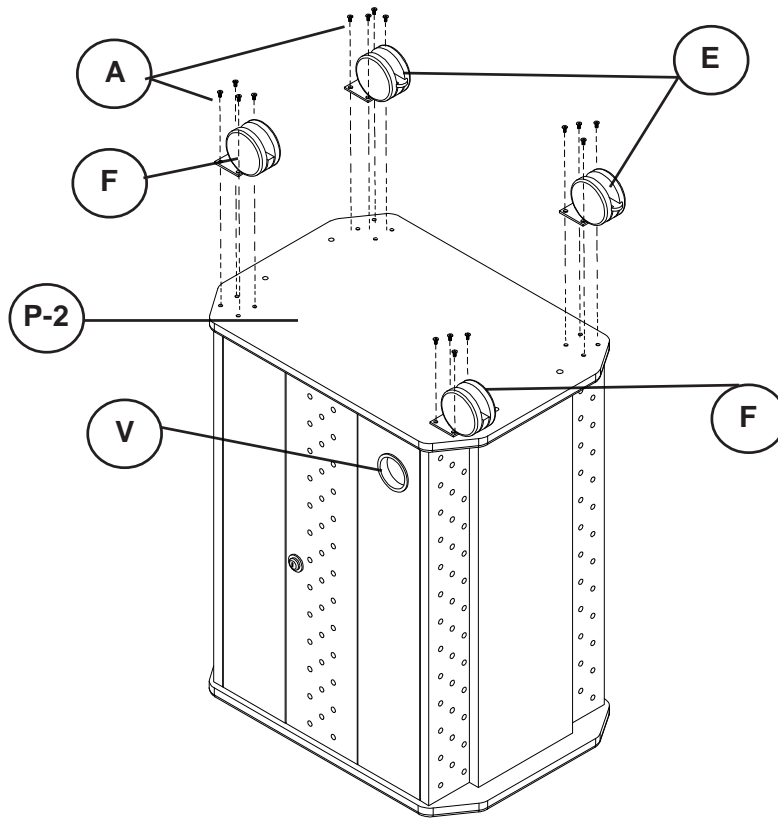

Illustration #8

10. Turn the unit over so the Casters are on the floor. Attach the Left Door (P-5) to the hinge on the Side assembly using six Door Hinge Screws (P) into the Door's predrilled hinge holes. Attach the Door Latch (N) to the top of the Left Door using four Door Latch Screws (O) as shown in illustration #9. Attach an Electrical Cord Holder (R) at the top and bottom of the Right Metal Side and through the punched holes so one is pointed up and the other down. Secure Holders using two Cord Holder Nuts (S) from the inside. See Detail 10A.

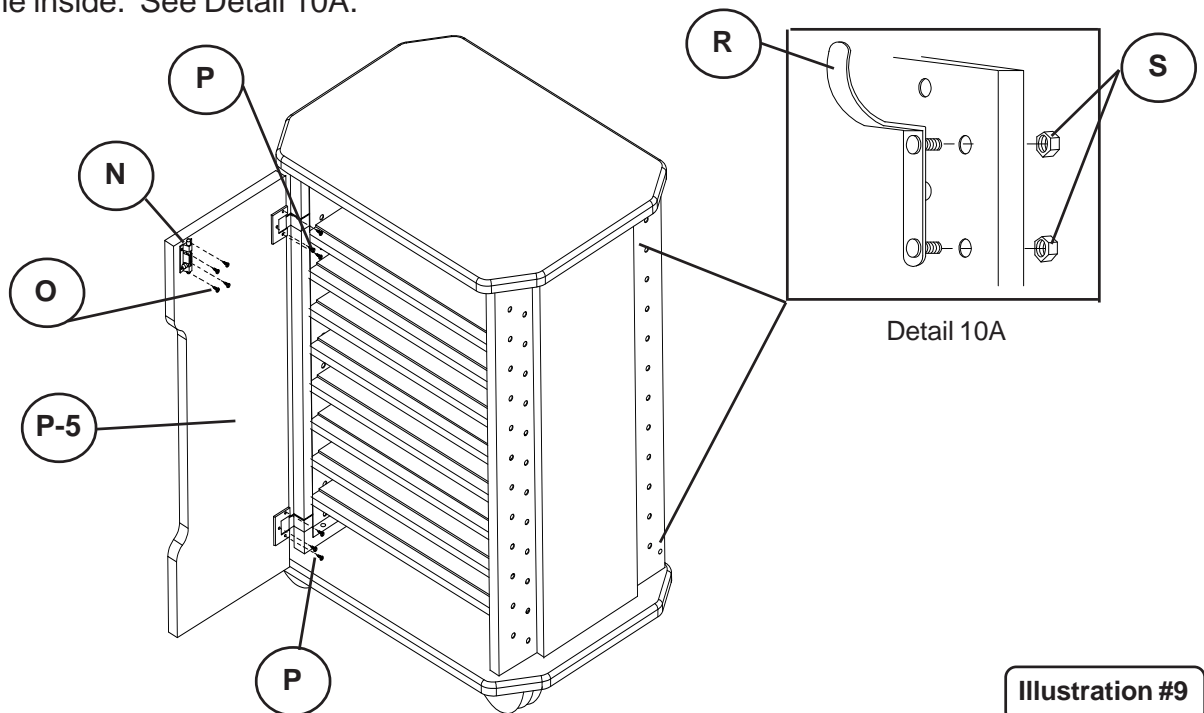
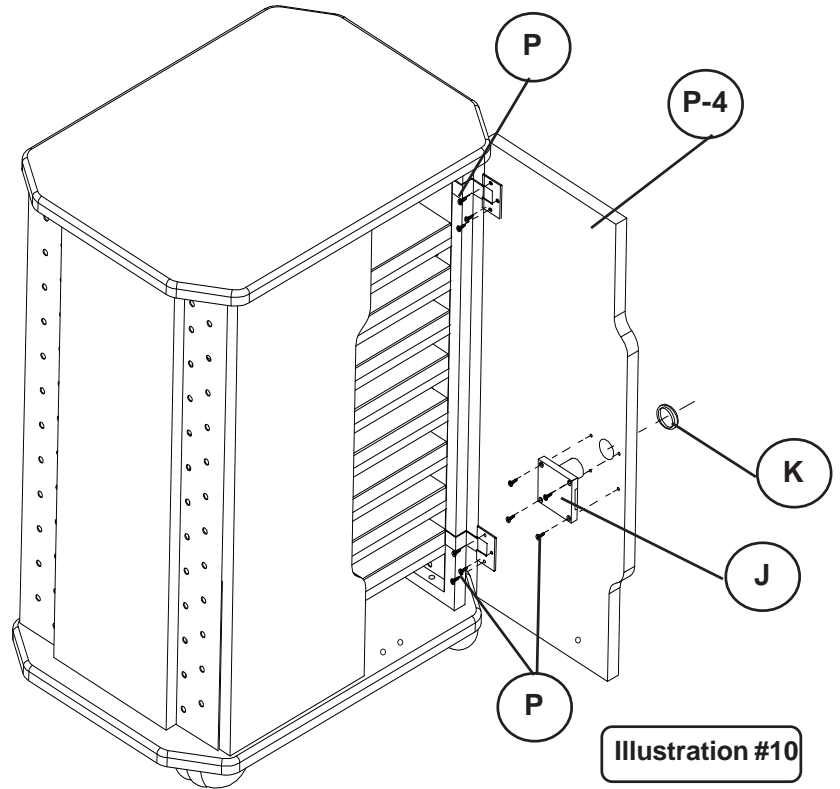
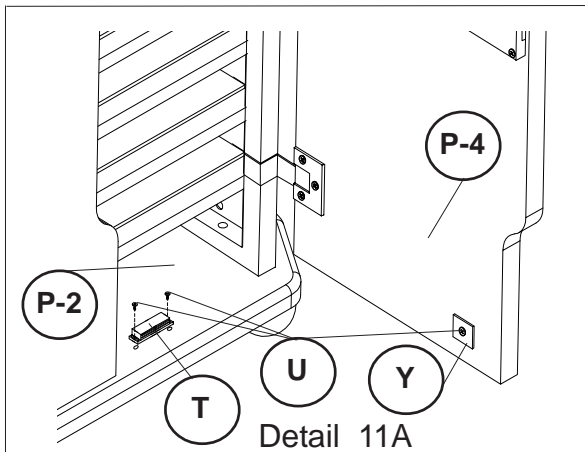

Illustration #9

11. Attach the Right Door (P-4) to the hinge on the Side assembly using six Door Hinge Screws (P) into the Door's predrilled hinge holes. Attach the Door Lock (J) to the back of the Right Door using four Door Screws (P) as shown in illustration #10. Push the Door Lock Bezel (K) in from the front and around the Door Lock barrel.

- 11A. Attach a Magnet (T) to the Bottom Panel (P-2) using two Magnet Screws (U) and going into the two predrilled holes as shown in Detail 11A. Attach a Magnet Plate (Y) to the bottom corner of the Right Door (P-4) using one Screw (U).



12. Snap in an Electrical Strip (58208) into the Electrical Clips (H) on the Left Back Panel (P-12) and one Electrical Strip (58208) into the Electrical Clips (H) on the Right Back Panel (P-11) as shown in illustration #11. Make sure the cords on the Electrical Strips are at the bottom so they can exit out the Grommet.

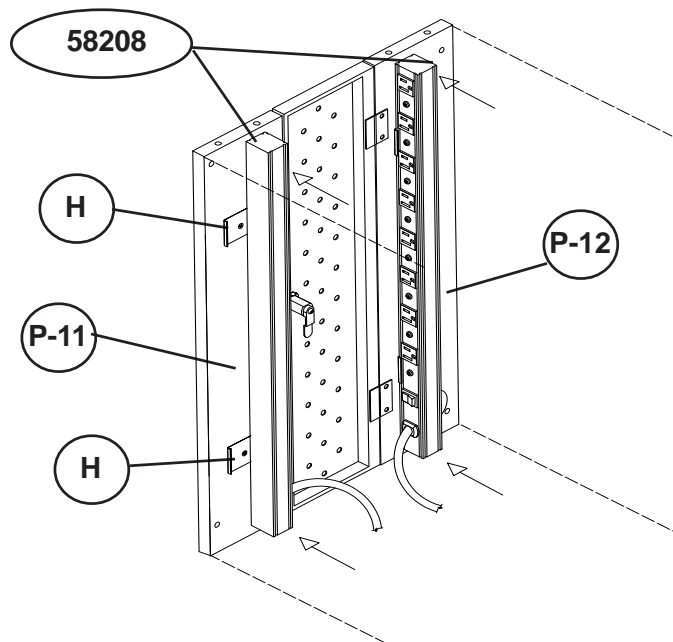

# 27689 Economy Tablet Charging Cart

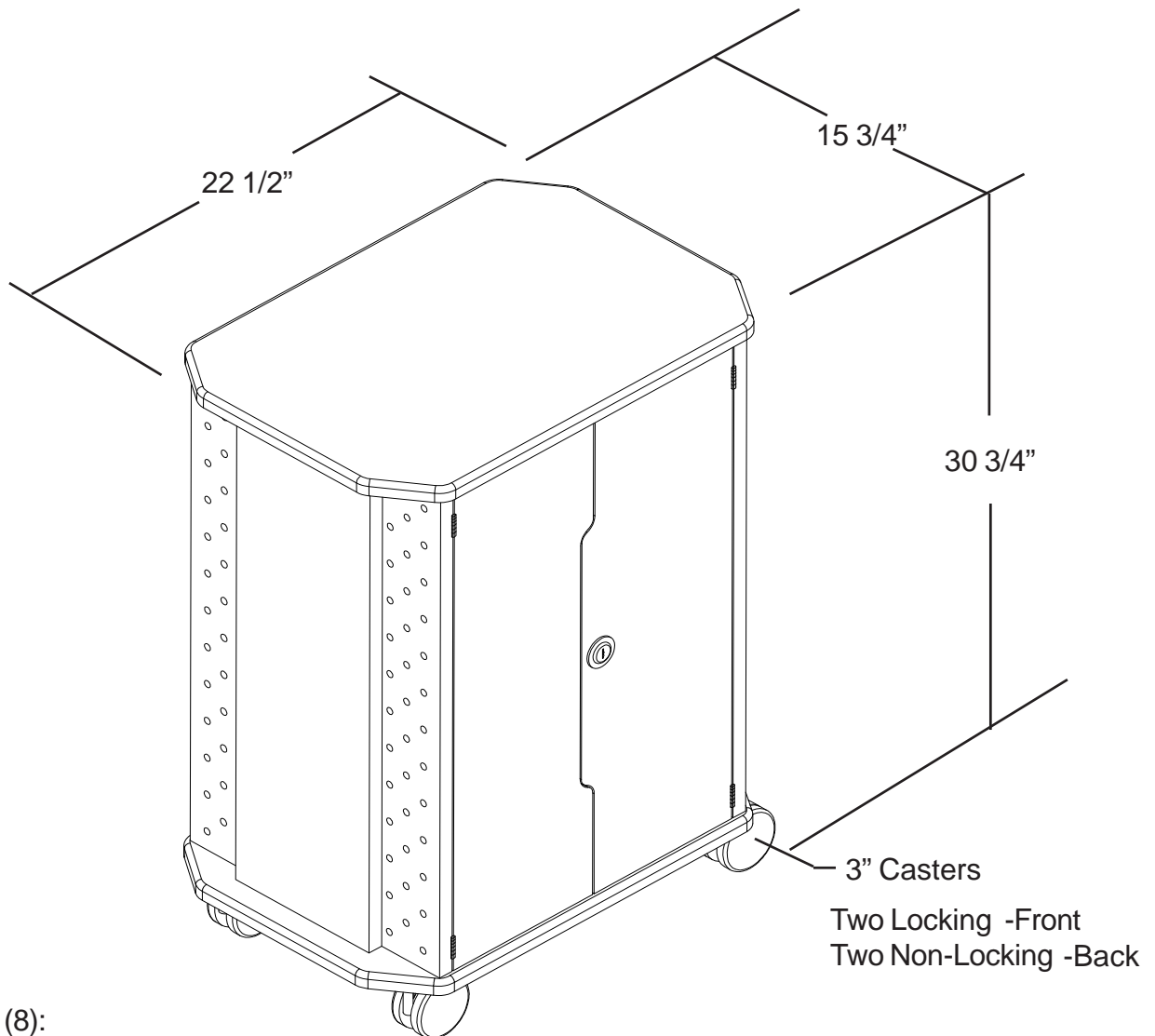

Shelves (8):  
16 1/2" W X 7 7/8" D  
2 1/8" Space Between

Two Electrical Outlet Strips  
each with 8 Outlets and 15' Cords