

Balt 4' x 8' Visionary Black Magnetic Glass Dry Erase Whiteboard

Instruction Manual



Provided by

MyBinding.com

When Image Matters.





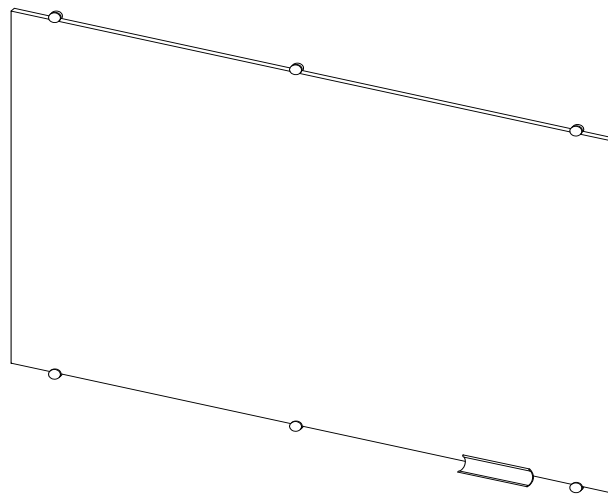



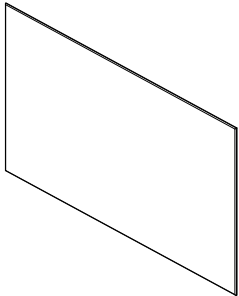

Call Us at 1-800-944-4573

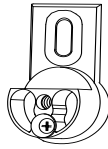
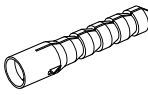
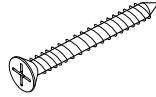
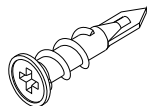
Visionary™ Boards

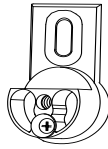
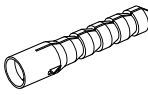
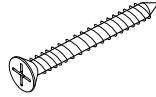
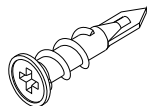

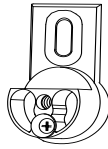
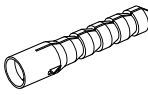
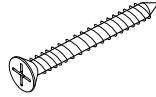
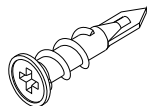
Assembly Instructions

Visionary™ Board with Aluminum Tray

| Part | Drawing | Description | Qty | Part | Drawing | Description | Qty | | | | | | | | | | | | | | | | | | |
|------|---|---------------------|------|--|---------|-------------|-----|---|--|-----------|---|--|------------|---|--|----------------|---|--|----------|---|---|----------------|---|---|---------------------|
| P-1 |  | Glass Board | 1 EA | <div style="text-align: center; border: 1px solid black; padding: 5px; margin-bottom: 10px;">Hardware List</div> <table border="0"> <tr> <td style="vertical-align: top; padding-right: 10px;">A</td> <td style="text-align: center; vertical-align: middle;"></td> <td style="vertical-align: middle;">Outer Cap</td> </tr> <tr> <td style="vertical-align: top; padding-right: 10px;">B</td> <td style="text-align: center; vertical-align: middle;"></td> <td style="vertical-align: middle;">Wall Mount</td> </tr> <tr> <td style="vertical-align: top; padding-right: 10px;">C</td> <td style="text-align: center; vertical-align: middle;"></td> <td style="vertical-align: middle;">Plastic Anchor</td> </tr> <tr> <td style="vertical-align: top; padding-right: 10px;">D</td> <td style="text-align: center; vertical-align: middle;"></td> <td style="vertical-align: middle;">CS Screw</td> </tr> <tr> <td style="vertical-align: top; padding-right: 10px;">E</td> <td style="text-align: center; vertical-align: middle;"></td> <td style="vertical-align: middle;">Drywall Anchor</td> </tr> <tr> <td style="vertical-align: top; padding-right: 10px;">F</td> <td style="text-align: center; vertical-align: middle;"></td> <td style="vertical-align: middle;">Phillips Tray Screw</td> </tr> </table> | | | | A |  | Outer Cap | B |  | Wall Mount | C |  | Plastic Anchor | D |  | CS Screw | E |  | Drywall Anchor | F |  | Phillips Tray Screw |
| A |  | Outer Cap | | | | | | | | | | | | | | | | | | | | | | | |
| B |  | Wall Mount | | | | | | | | | | | | | | | | | | | | | | | |
| C |  | Plastic Anchor | | | | | | | | | | | | | | | | | | | | | | | |
| D |  | CS Screw | | | | | | | | | | | | | | | | | | | | | | | |
| E |  | Drywall Anchor | | | | | | | | | | | | | | | | | | | | | | | |
| F |  | Phillips Tray Screw | | | | | | | | | | | | | | | | | | | | | | | |
| P-2 |  | Tray Mount | 1 EA | | | | | | | | | | | | | | | | | | | | | | |
| P-3 |  | Aluminum Tray | 1 EA | | | | | | | | | | | | | | | | | | | | | | |

WARNING

Visionary Boards are made of Safety Glass, but the improper handling and installation may cause serious injury if the board shatters.

SPECIAL NOTE:

Make sure your wall is flat. On sheetrock and stud walls, always try to hit studs if possible. A minimum of 1/2" sheetrock is required. Use the correct type anchor and predrill for the type wall you will be mounting your new glass board onto.

Important Information

Do not use unless all screws are tight. At least every six months, check all screws to be sure they are tight. If parts are missing, broken, damaged, or worn, stop use of the product until repairs are made by your dealer using factory authorized parts.

Preparing to Install Your New Visionary™ Board

- Determine the type wall you are mounting your new board on.
- Measure the length, width and center lines of your board and your wall. Determine the height off the floor that you want the bottom of your board. Most boards are mounted about 36" off the floor.
- With help, hold your board up in position and draw a line around the perimeter. Make sure these drawn lines are parallel with the ceiling and floor.
- If your wall has studs, it is recommended that you mount into as many studs as possible.

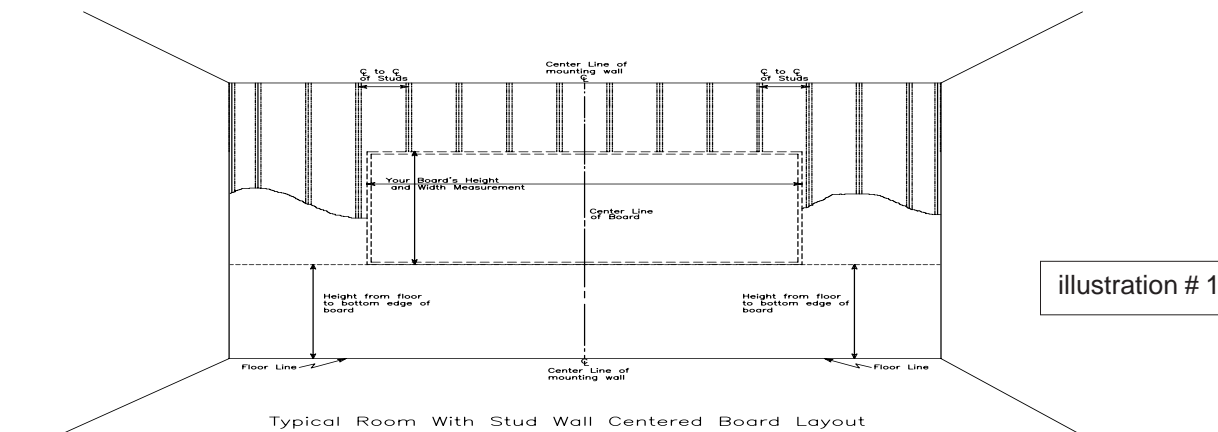

NOTE: The proper installation of your board will require at least two people.
Tools required: Tape measure, chalkline, electric drill / screwdriver, drill and screwdriver bits, stud finder and level.

To Assemble and Attach to Wall:

- Identify and Separate all the Parts and Hardware.
- Pick the correct type of mounting hardware and anchors for your type wall.
- Measure up 1 1/4" above the bottom line and draw another line that is parallel. Measure in about 6" from each side and install your bottom Wall Mounts (B) as shown in illustrations #2 and Detail #2a. The Wall Mounts (B) should be placed on 16" centers as a minimum and not more than 24" as a maximum.

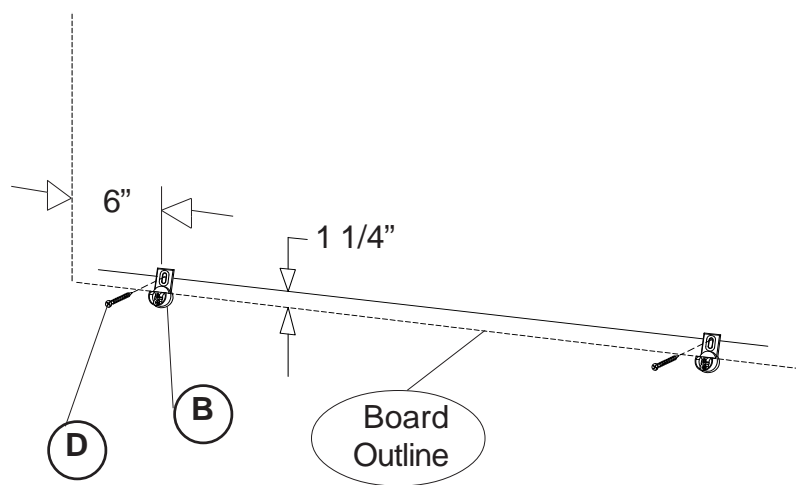
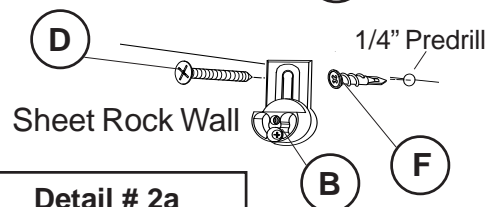
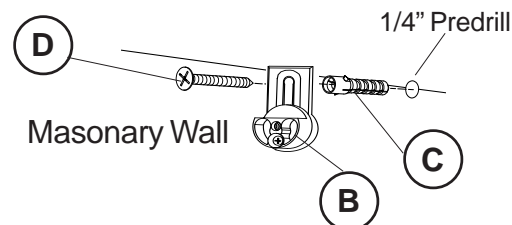
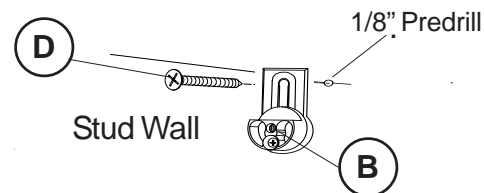
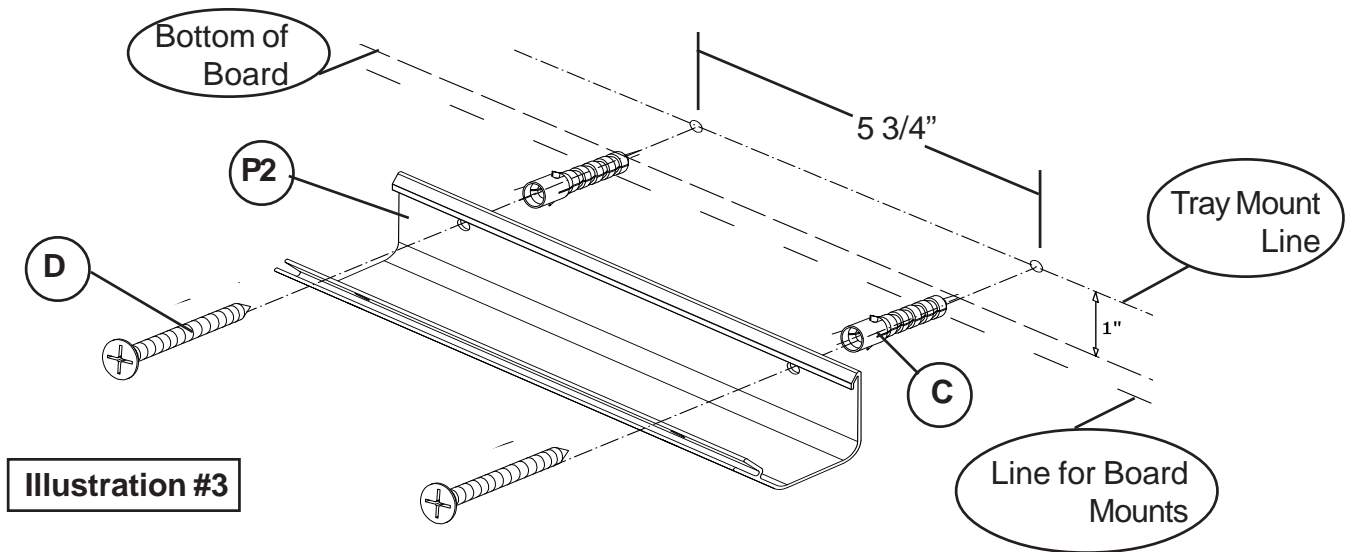

illustration # 2



Detail # 2a

4.) Determine where you want your tray to be located and mark a line 1" above the bottom edge of your board. Drill two 5/16" diameter holes in the wall 5 3/4" apart.



5.) Push in two Plastic Anchors (C) into the predrilled holes. Place the Tray Mount (P-2) over the Plastic Anchors (C) and secure with two CS Screws (D) as shown in Illustration #3.

6.) Place the Aluminum Tray (P-3) in the front slot of the Tray Mount (P-2) and align the holes. Secure the Aluminum Tray (P-3) to the Tray Mount (P-2) using two Phillips Tray Screws (F). See Illustration #4.

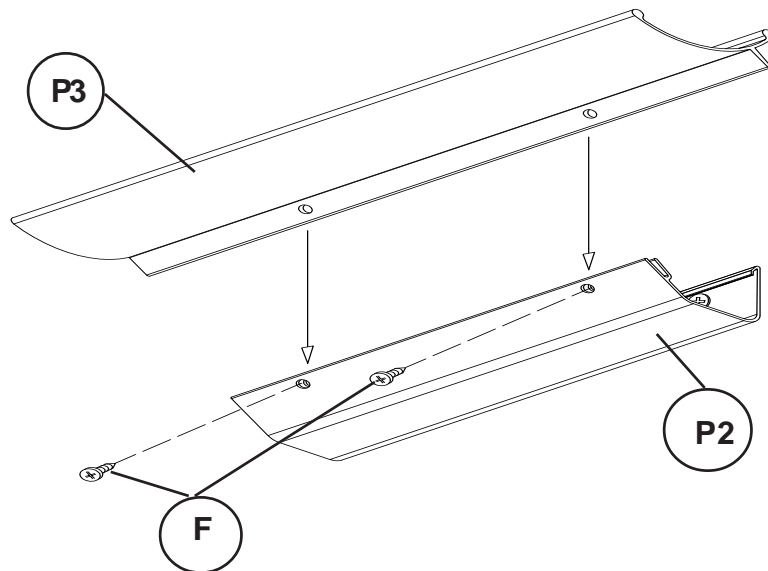

7.) Measure down 3/4" from the top line and draw another line that is parallel. Measure in about 6" from each side and install your top Wall Mounts (B). Leave the top Wall Mounts pushed up as shown in illustration #5.

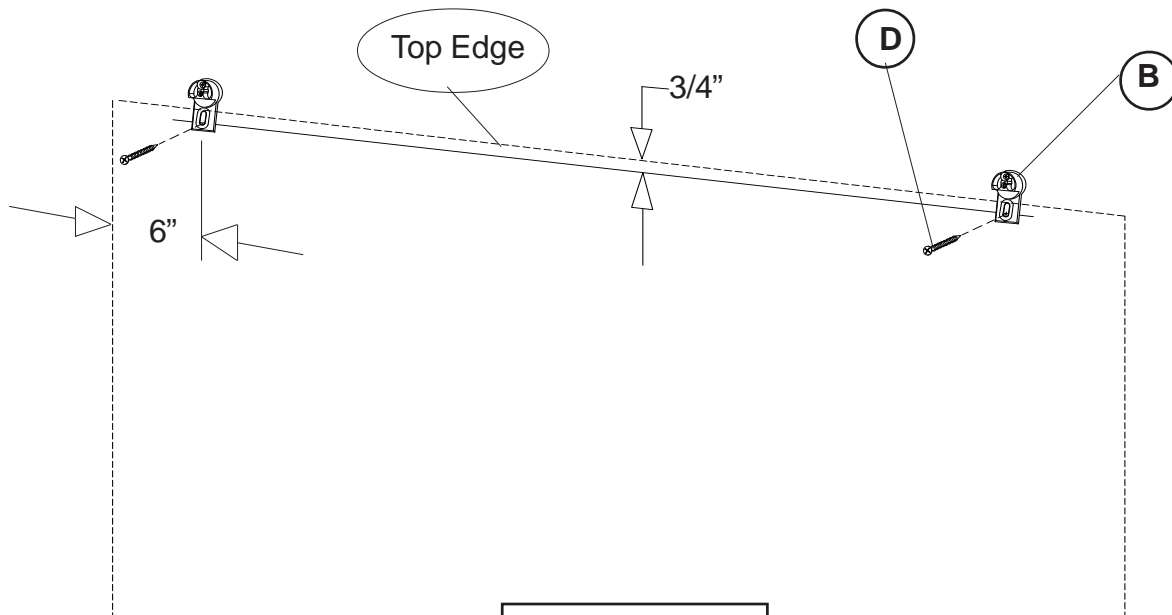

8.) Place the Glass Board (P1) on the bottom Wall Mounts (B) and screw in the Outer Caps (A) to secure. Tilt the Glass Board back and push down the top Wall Mounts (B) onto the board's top edge. Secure board in place by screwing in the top Outer Caps (A) as shown in illustration #6.

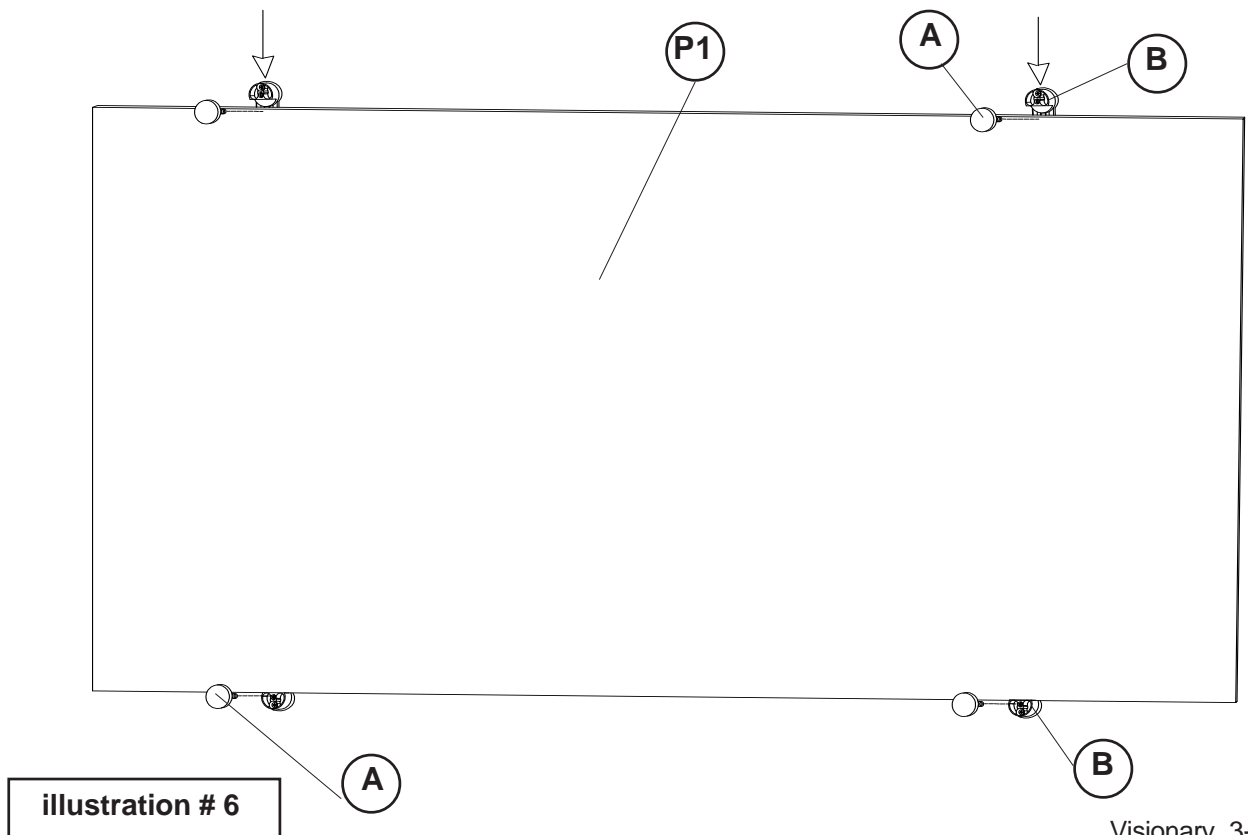

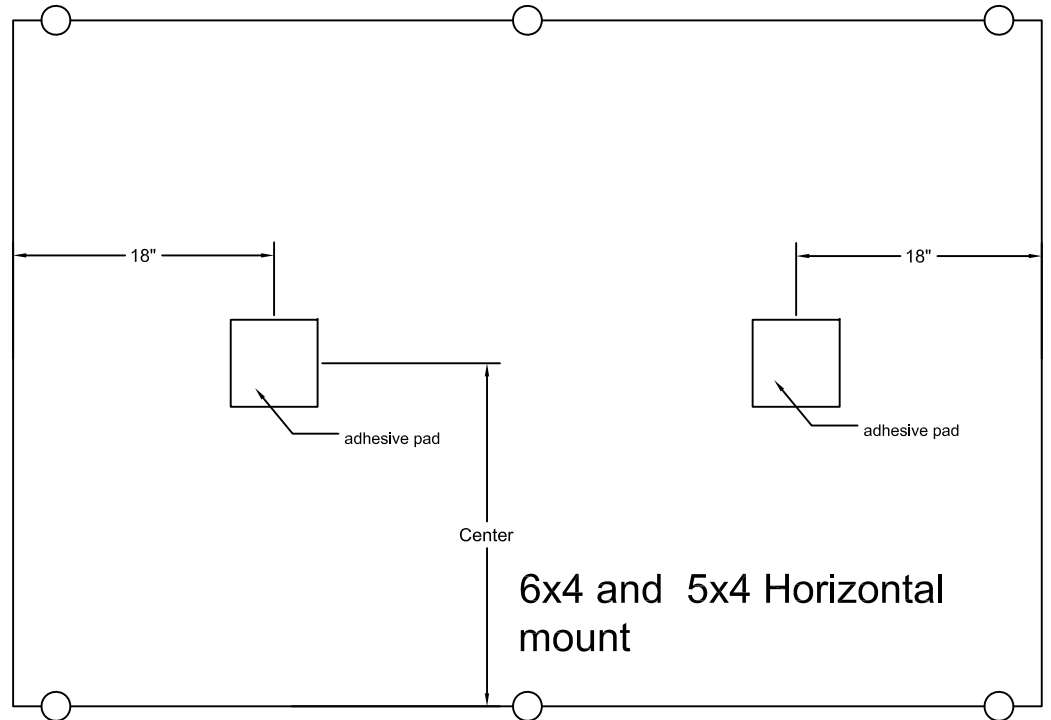
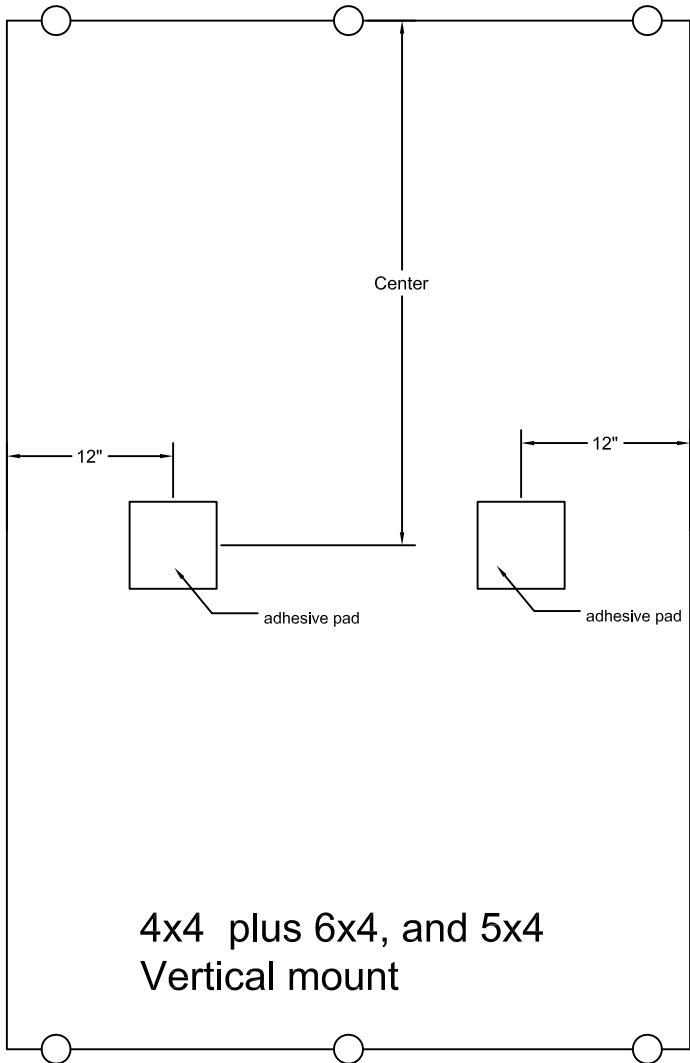

For application of self adhesive pads for 6', 5' and 4' glass boards peel one side of the backer from the pad and apply to the board per the drawings - then peel the other side before mounting on the wall - carefully position the the panel left to right before applying pressure against the wall.