

# ***DecoAurora 3'x4' Magnetic Markerboard - Red Trim***

Product Spec Sheet



*Provided by*

**MyBinding.com**  
*When Image Matters.*

Call Us at 1-800-944-4573

# DFM Series

## DECO *Aurora* Color Accented Whiteboards

ghent.

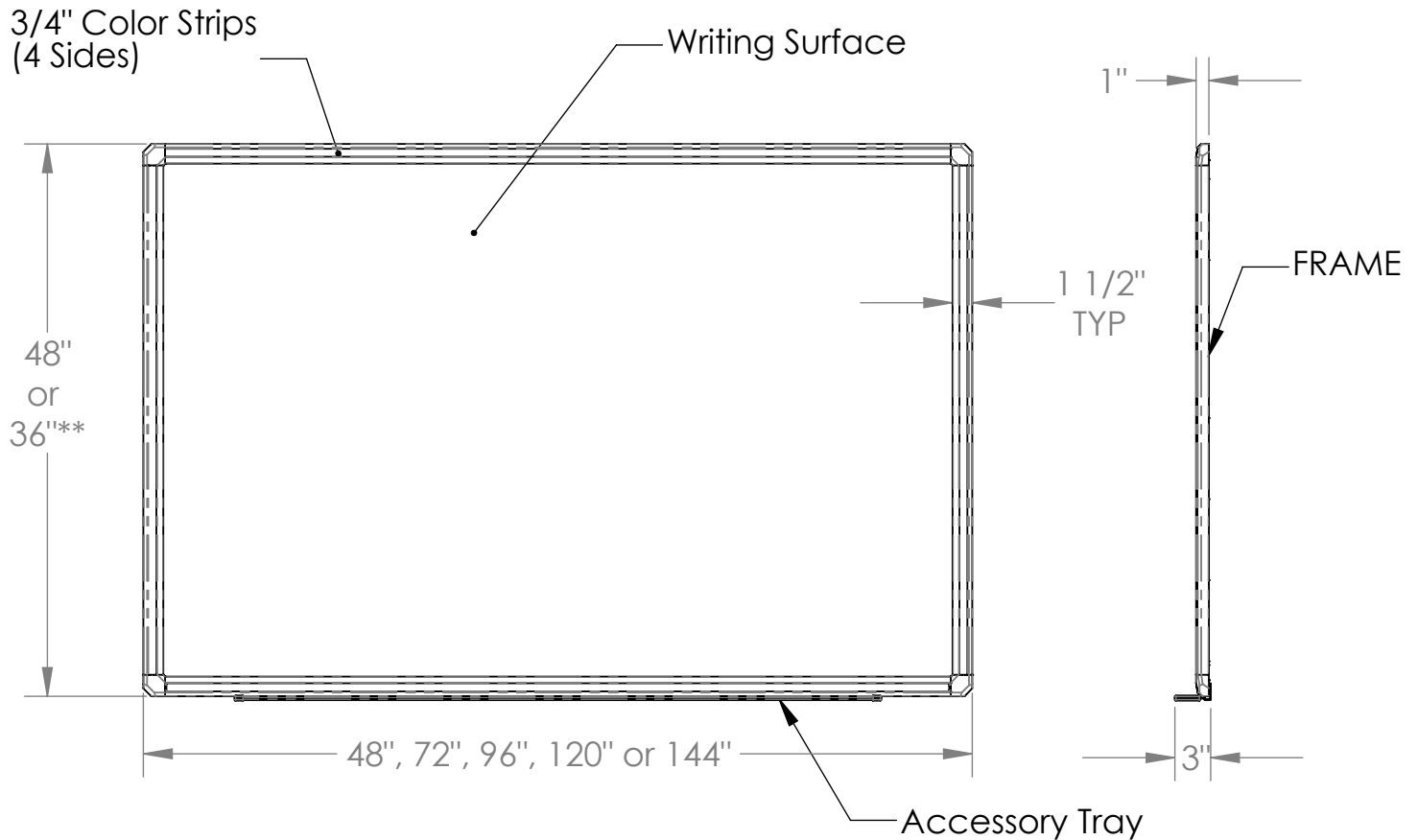

### Materials:

- The framing and accessory tray are satin anodized aluminum extrusion.
- Writing surface is white porcelain coated 28 gage steel sheet laminated to 1/2" thick particle board with a mylar film backing.
- Frame corners are medium gray ABS plastic.
- Marker rail end caps are medium gray thermoplastic.
- Color trim strips are thermoplastic PVC.

### Features:

- Available in five board lengths.
- Mounting fasteners are concealed after installation.
- Color trim strips are available in nine solid colors (Burgundy, Black, Gray, Hunter Green, Navy, Purple, Red, Royal Blue, or Yellow) and three wood grains (Cherry, Light Maple, or Mahogany).
- (1) eraser and (4) color erasable markers are included with each marker board.

### Notes:

*\*\* 48" width board only.*

*Mounting hardware not included.*

*The colors trim strips are to be installed by the customer after mounting the board.*

MyBinding.com

5500 NE Moore Court

Hillsboro, OR 97124

Toll Free: 1-800-944-4573

Local: 503-640-5920

PSS-DFM 9/13



Burgundy=(BG)

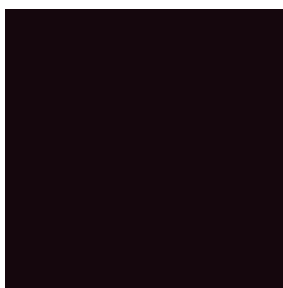

Black=(BK)



Gray=(GY)

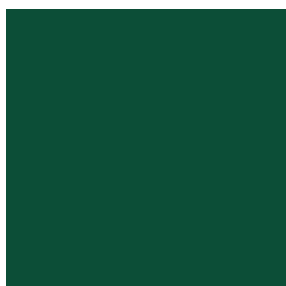

Hunter Green=(HG)



Navy=(NV)



Purple=(PE)



Red=(RD)

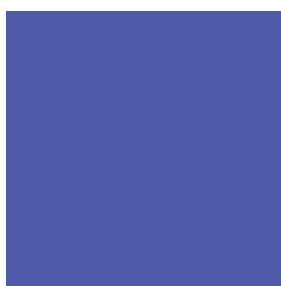

Royal Blue=(RY)



Yellow=(YW)

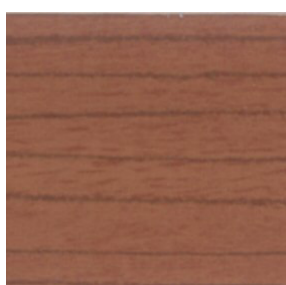

Wood Grain - Cherry=(CH)

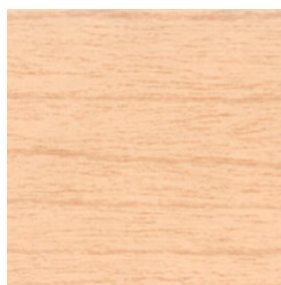

Wood Grain - Lt. Maple=(LM)

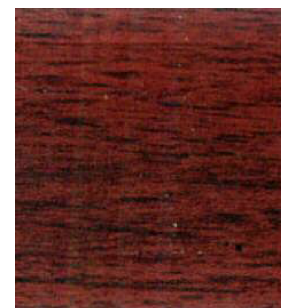

Wood Grain - Mahogany=(MH)



Gray (Corners / Marker Rail End Caps)

MyBinding.com  
5500 NE Moore Court  
Hillsboro, OR 97124  
Toll Free: 1-800-944-4573  
Local: 503-640-5920