



The Fletcher-Terry Company

OWNER'S MANUAL

Fletcher Gemini Pro



Gemini Pro

The Fletcher-Terry Company

65 Spring Lane • Farmington, CT USA 06032-3311

Tel 860.677.7331 • Toll-Free 888.888.5165 • Fax 860.676.8858 • customerservice@fletcher-terry.com • www.fletcher-terry.com

Form ENG-040209

TABLE OF CONTENTS

INTRODUCTION	i
PRODUCT WARRANTY	i
SAFETY FIRST	ii
I. OPERATING THE GEMINI PRO	
1. Unpacking Materials	1
A. Gemini Pro Components	1
2. Installing the Sight-Line Guide Strip	1
A. Attaching the Cutter to the Atlas Workbench	2
B. Alternative Installation	2
C. Mounting the Shelf Brackets for Storage.....	2
3. Installing the Blade.....	3
4. Inserting the Blade Magazine.....	3
5. Cutting Various Materials	3
A. Cutting Flexible Materials	3
B. Cutting Board Materials	3
II. GENERAL MAINTENANCE, TROUBLESHOOTING, & FAQ	
6. General Maintenance Tips	5
7. Adjusting the Cutting Head.....	5
8. Troubleshooting Guide	5
9. Frequently Asked Questions	6
10. Replacement Parts List	6
11. Common Consumables and Accessories.....	6

Introduction

Congratulations on purchasing a Fletcher Gemini Pro. You have a tool that will perform consistently and made of a long-lasting durable material. The Gemini cutters are perfect for all your cutting needs—taking care of your cutting *and* trimming needs in one machine—and cutting PVC, polycarbonate, corrugated plastic, Gatorboard, foamboard and any other scissorable material.

The Gemini Cutters has a straightness tolerance of .039" (1mm), and is an affordable, reliable solution for all your general purpose cutting and trimming challenges. The Gemini Pro is a cutter with two piece construction set by the factory to a .008" (0.2mm) straightness tolerance over the entire life of the machine—great for environments where extreme straightness is necessary. The Gemini or Gemini Pro is a perfect match with the Fletcher Atlas workbench, giving them the most even, level surface you can find, and that produces a clean, straight cut.

Take proper care of your cutter and use it according to the instructions in this manual to get the maximum return for your investment. *If you are not using your Gemini Pro with the Atlas workbench, make sure to use the proper substrate material on your work surface to get a clean cut.*

Please read the operating instructions and the **SAFETY FIRST!** section carefully BEFORE you operate your Gemini Pro Cutter to make sure you get the best performance from your purchase. If you have any questions, you can find more information at Fletcher's website at www.fletcher-terry.com or contact our Customer Service Department toll-free at 800.843.3826 in the United States. Outside the United States, call ++860.677.7331.

Product Warranty

The Fletcher-Terry Company warrants the machine purchased to be free from defects in parts and workmanship for one (1) year from the date of purchase. The Fletcher-Terry Company warrants that it will repair or replace any such defective machine or replace parts, providing the machine has been under normal use and service and the defective part or machine is returned to The Fletcher-Terry Company at the purchaser's expense. The Fletcher-Terry Company must authorize the return in writing. Proof of purchase must be submitted to validate warranty coverage. The warranty is in lieu of all other agreements and warranties expressed or implied. THE FLETCHER-TERRY COMPANY DOES HEREBY EXPRESSLY DISCLAIM ANY WARRANTIES OF MERCHANT ABILITY OR FITNESS FOR A PARTICULAR PURPOSE. The Fletcher-Terry Company does not authorize any company employee or representative to assume for it any other liability than that set forth in this Product Warranty. The Fletcher-Terry Company shall not be liable for any damages or losses, whether incidental or consequential, direct or indirect, arising out of the use or abuse of this machine. This Warranty is valid only when machine is used with Fletcher consumables and replacement parts. In any event, THE PURCHASER'S SOLE AND EXCLUSIVE REMEDY UNDER THIS OR ANY OTHER WARRANTY IS LIMITED TO RETURN OF THE PURCHASE PRICE PAID FOR THIS MACHINE.

SAFETY FIRST!

Please read through this manual before operating the Fletcher Gemini Pro. If after reviewing these pages you still have questions about using the machine, contact our Customer Service Department toll-free at 800.843.3826 in the United States. Outside the United States, call ++860.677.7331 or you may email us at customerservice@fletcher-terry.com

- It is the employer's responsibility to enforce compliance with these safety warnings and procedures by all who use the Gemini Pro cutters. Keep this manual available so all employees have access to it and have the opportunity to review procedures periodically.
- The intended purpose of the Gemini Pro is for cutting and trimming Gatorboard, foamboard, PVC, corrugated plastic, polystyrene and any other scissorable materials. It must not be modified or used for any other application or purpose.
- Keep fingers away from the blade when cutting and cleaning the machine.
- Make sure your cutters are used on flat, level surfaces. An uneven tabletop or workbench will result in a bowed cut.
- If there is any damage to the cutting head or cutter bar assembly, **DO NOT USE THE CUTTER.**
- Remove the blade before cleaning your cutter.
- Always use safety glasses. The operator of this machine, and others in the work area, must wear safety glasses with rigid side shields.
- Only use the parts, supplies and accessories that are recommended by Fletcher-Terry.
- Make sure that the work area is well lit, free from clutter and set-up in a way that promotes proper ergonomics.

Operation

I. OPERATING THE GEMINI PRO

1. Unpacking Materials

Check the exterior of the packing box to make sure there is no visible damage. After unpacking the unit, check to make sure you have all the parts and there is no damage to the machine. Lay out drill for attaching wall brackets, if you did not purchase the Atlas Workbench.

A. Gemini Pro Components

- Rail with Cutting Head already assembled
- Shelf brackets to hang machine when not in use (not used with Atlas Workbench). The number of brackets corresponds to the size of the cutter.
 - ✓ Two (2) brackets for Gemini Pro 40", 60" or 80" (1m, 1.5m or 2.0m)
 - ✓ Three (3) brackets for Gemini Pro 100" or 120" (2.0m and 3m)
- One (1) Cutting Blade Magazine with Blade Stiffener
- One (1) Box of 100 Blades
- One (1) Sight-Line Guide Strip
- Hex Key Wrenches (2mm & 2.5mm)

2. Installing the Sight-Line Guide Strip

1. Position the Gemini Pro upside down with both ends raised to keep the Cutting Head suspended above the work surface.
2. Ensure the cutting edge of the unit is in front of you.
➤ **Tip: Use two (2) boxes approximately the same size to support the cutter.**



CAUTION: Do not place the cutter directly on its Cutting Head or damage may occur.

3. Locate the yellow rubber strip in the slot that is closest to the cutting edge on the unit. (**Figure 1**)
4. Carefully remove it.
5. Using a clean cloth and 50-70% isopropyl alcohol (rubbing alcohol), clean any dirt or debris from either side of the newly created slot.

◆ **Note: Let the alcohol dry completely before continuing to the next step.**

6. Locate the green Sight-Line Guide Strip from the unpacked materials.
7. Position the Guide Strip so the green portion is above the cream-colored portion.
8. Peel back approximately 6" (155mm) from the right side of both of the blue adhesive liners. (**Figure 2**)
9. Turn over the Guide Strip and position the rib of the Guide Strip over the slot.

◆ **Note: The green plastic strip is toward the cutting edge.**

10. Start the Guide Strip approximately 1/8" (4mm) in from the right black End Cap. (**Figure 3**)



Figure 1

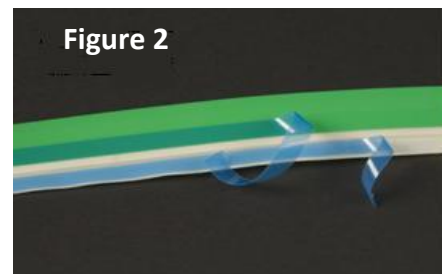

Figure 2

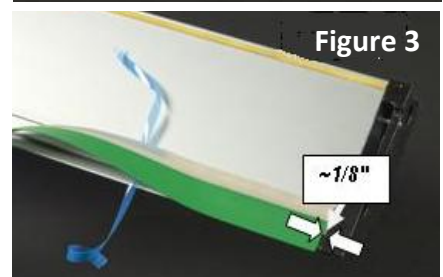
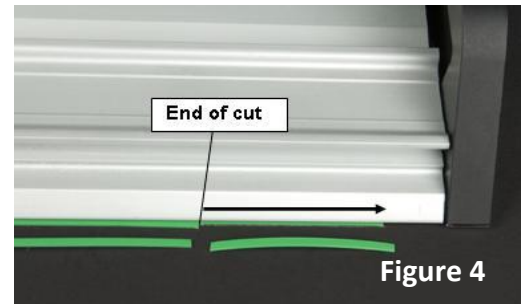

Figure 3

Operation

11. Press down firmly to ensure the Guide Strip rib is embedded in the slot.
12. Gradually peel back, and press down both blue liners until the Guide Strip is completely adhered.
♦ **Note: The Guide Strip will end approximately 1" (28mm) from the left black End Cap.**
13. Confirm the Guide Strip is completely secured before continuing.
14. Turn over the cutter.
15. Place it on a firm cutting surface.
16. Install the Blade Magazine (see "Inserting the Blade Magazine" and "Installing the Blade" on page 3) with the Blade in the back stop position for cutting thinner material).
17. Position the Cutting Head to the far left of the cutter.
18. Slightly rotate the Cutting Head down so the Blade cuts partially into the green Guide Strip.
♦ **Note: Do not cut all the way through the green Guide Strip on the first pass.**
19. Repeat Steps 17 and 18 once more, cutting all the way through the material this time.
♦ **Note: There will be a portion on either end of the Guide Strip that will not be cut.**
20. Remove the Blade Magazine, and move the Blade to the forward stop position.
21. Reinsert the Magazine into the cutter.
22. Position the Cutting Head to the far left.
23. Make another cut just until the new cut meets the original cut.
24. Move the Cutting Head to the middle of the cutter.
25. Using a utility knife, continue the cut made by the Gemini Pro on either end of the Guide Strip, and remove the excess Guide Strip. (**Figure 4**)



A. Attaching the Cutter to the Atlas Workbench

- a. Ensure the two (2) black handles on the Atlas Workbench are in the lowered position.
- b. Locate the gap in the center of either End Cap of the cutter.
- c. Position the gaps over the receiving tabs of the Atlas Workbench, and lower into position.

♦ **Note: For information regarding the assembly of the Atlas Workbench, please reference the Atlas Owner's Manual.**

B. Alternative Installation

When not using the Atlas Workbench, put the Gemini Pro Cutter on a flat, even surface to ensure a straight cut.

♦ **Note: Optional Table Mount Elevators are available to raise and lower the Gemini Pro on your work surface. Please contact Fletcher-Terry's Customer Service Department at 800.843.3826, and reference Part #04-739 for more information.**

C. Mounting the Shelf Brackets for Storage

- a. Locate one wall stud per shelf bracket. Different models have different numbers of brackets.
- b. Using a drill, secure the brackets in place.
➤ **Tip: Use a level to ensure the brackets are at the same height.**

Operation

3. Installing the Blade

There are three (3) components to the complete blade assembly unit: the Cutting Blade, the Magazine, and the Blade Stiffener. Make sure you have all three parts before continuing. When cutting material up to ¼" (7mm) thick, use the back stop position in the Magazine. When cutting material ¼" (7mm) to ½" (13mm) thick, use the forward stop position in the Magazine.



CAUTION: Blades are very sharp, so use care when handling blades or positioning the magazine.

1. Locate the Blade Magazine.
2. Remove the Blade Stiffener from its position in the Magazine.
3. Position the Blade in the forward stop position for cutting thicker materials, or in the back stop position for cutting thinner materials.
4. Replace the Blade Stiffener, and place it on top of the blade.



Installing Blade



Blade in Blade Magazine with Stiffener

4. Inserting the Blade Magazine

1. Loosen the black Blade Locking Knob located on the front of the Cutting Head.
2. Hold the Magazine so the Blade Stiffener is facing you and the blade is to the left.
3. From the right side of the Cutting Head, gently slide the Magazine into position.
4. Tighten the black Blade Locking Knob to secure the Magazine in place.



Loosen Black Knob

5. Cutting Various Materials

The Gemini Pro can cut materials up to ½" (13mm) thick. The manual describes "pushing" or "pulling" the Cutting Head. You may use your own judgment on the easiest method for cutting.

A. Cutting Flexible Materials

1. Position material under the Cutting Rail so the cutline matches up with the Guide Strip.
2. Position the Cutting Head to its farthest left position.
3. Place your right hand on top of the Cutting Head, and rotate the Cutting Head down so the Blade is depressed.
4. Pull the Cutting Head to the right until it has completed its cut.

Operation

B. Cutting Board Materials

1. Position material under the Cutting Rail so the cutline matches up with the Guide Strip.
2. Position the Cutting Head to its farthest left position.
3. Place your left hand on top of the Cutting Head, and rotate the Cutting Head down so the Blade is depressed.
4. Push the Cutting Head to the right until it has completed its cut.

◆ **Note: Multiple passes may be needed for thicker material.**

Maintenance, Troubleshooting and FAQ

6. General Maintenance Tips

With care and frequent cleaning, the Gemini Pro Cutter will remain in proper adjustment and will perform as expected indefinitely.

The most important maintenance requirement is wiping the machine frequently with a dry cloth. No oil or synthetic lubricants should be used or the plastic components could be damaged. Silicone lubricant spray can be used on the Cutting Head Track, if necessary.



CAUTION: Remove the blade before cleaning the machine.

7. Adjusting the Cutting Head

The bearings that allow the Cutting Head to slide are made of quality materials and will last a long time. Normal use will cause them to settle into position, and they might develop a slight amount of movement side-to-side. Tighten the Head Adjustment Screws in order to eliminate this.

To avoid over tightening, slide the Cutting Head slowly while tightening to ensure that it slides smoothly.



8. Troubleshooting Guide

Check the guide below to troubleshoot some common issues during the use of your Gemini Pro Cutter. If the Troubleshooting Guide or the Frequently Asked Questions section listed below does not answer your questions, please contact our Customer Service Department at 800.843.3826, or send an email to customerservice@fletcher-terry.com.

Symptom	Probable Cause	Correction
Ragged Edge	Blade is dull	Replace blade
Head drags too much	Bearings are too tight	Re-adjust bearings
Head moves side-to-side	Bearings are too loose	Adjust bearings

For online technical support, go to <http://www.fletcherterry.com/contact/support.shtml>

Maintenance, Troubleshooting and FAQ

9. Frequently Asked Questions

Q: What is the cut size capacity?

A: The cut capacity for Gemini Pro is 40" (1m), 60" (1.5m), 80" (2.0m), 100" (2.5m) and 120" (3m).

Q: What is the maximum material thickness?

A: The maximum thickness is ½" (13mm).

10. Replacement Parts List

To order Replacement Parts, contact Fletcher-Terry's Customer Service Department at 800.843.3826 in the United States. Outside the United States, call ++860.677.7331 or go to the online buying section on our website at www.fletcher-terry.com.

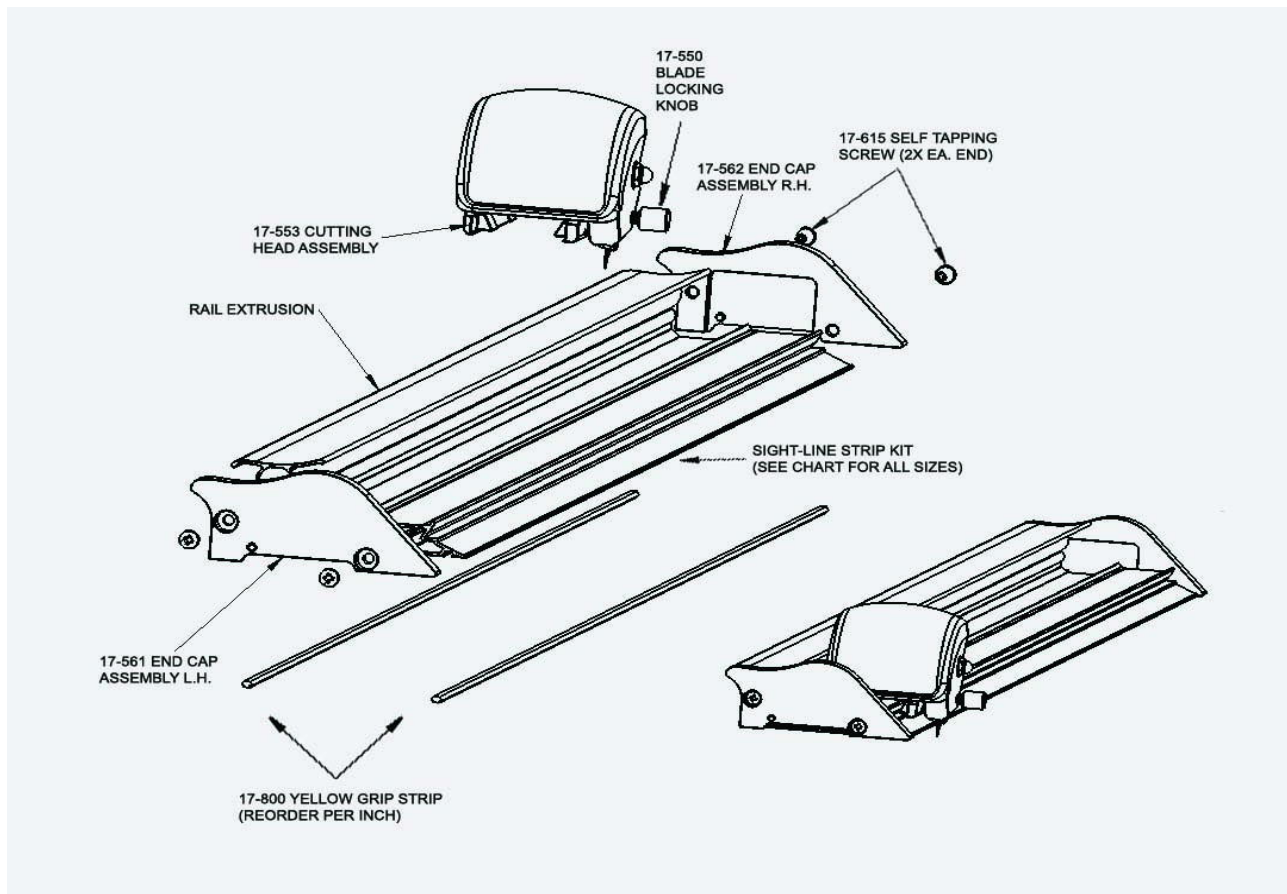

11. Common Consumables and Accessories

Part Description	Part Number
Blades (Box of 100)	05-004
Blade Magazine Assembly	04-783
Gemini Pro Table Mount Elevators	04-739
Yellow Polyfoam Grip Strip	17-800
Blade Stiffener Assembly	17-551
Bumper & Bearings Replacement Kit <i>(for Cutting Head assembly)</i>	17-560
Gemini Pro Sight-Line Guide Strip Kit (40")	17-810
Gemini Pro Sight-Line Guide Strip Kit (60")	17-811
Gemini Pro Sight-Line Guide Strip Kit (80")	17-812
Gemini Pro Sight-Line Guide Strip Kit (100")	17-813
Gemini Pro Sight-Line Guide Strip Kit (120")	17-814

Workstations Available (Optional)

Atlas Workbench 40" (1.0m)	04-760
Atlas Workbench 60" (1.5m)	04-761
Atlas Workbench 80" (1.5m)	04-762
Atlas Workbench 100" (2.5m)	04-763
Atlas Workbench 120" (3.0m)	04-764

