



MyBinding.com
5500 NE Moore Court
Hillsboro, OR 97124
Toll Free: 1-800-944-4573
Local: 503-640-5920

ProCut Paper Cutter

Model 20P

INSTALLATION & OPERATION MANUAL

Document Number: 1729247 Rev. A
Do not duplicate without written permission from ACCO Brands.



Store this instruction manual in a safe place for future reference.



ACCO Brands reserves the right to make changes to this publication and to the products described in it without notice. All specifications and information concerning products are subject to change without notice. Reference in this publication to information or products protected by copyright or patent does not convey any license under the rights of ACCO Brands or others. ACCO Brands assumes no liability arising from infringements of patents or any other rights of third parties.

This publication is copyrighted © 2015 by ACCO Brands. All rights reserved.

INTRODUCTION

The equipment is designed to provide you with improved productivity, versatility, and quality.

Note: Depending on the model and its version, the photos in this manual may not look like your machine. However, the components and functions are the same.

FEATURES

- Intuitive user LCD display
- Programmable for up to 80 programs with up to 99 steps
- Electric blade, clamp and back gauge

BENEFITS

- LED optical cut line ensures accuracy
- Reset button recalibrates machine for accuracy
- Full programmability increases speed of cutting

SAFETY

- Two handed cut and clamp activation buttons
- Mechanical safety latch and light curtain safety shield
- Push-out feature moves media forward after the cut is complete

MyBinding.com
5500 NE Moore Court
Hillsboro, OR 97124
Toll Free: 1-800-944-4573
Local: 503-640-5920





TABLE OF CONTENTS

Introduction..... i
 Features i
 Benefits i
 Safety i

1. Safety

Cautions 1-2
 General..... 1-2
 Electrical..... 1-2
 GBC Technical Service 1-2

2. Warranty

Limited One Year Parts, 90 Days Labor Warranty;
 USA, Mexico, and Canada 2-1

3. Specifications

FCC Class A Notice 3-2
 Canada Class A Notice - Avis Canada, Classe A 3-2
 Modifications 3-2

4. Installation

GBC Technical Service 4-1
 Prior to Installation..... 4-1
 Installation 4-1
 Location 4-2

5. Feature Guide

Infrared Safety Walls 5-1
 Jogging Aid..... 5-1
 Back Gauge..... 5-1
 The Clamp & Cutting Blade..... 5-1
 Cut Stick 5-1
 Control Panel..... 5-2
 A. LCD Display 5-2
 B. Keypad..... 5-2
 C. Operation Buttons 5-3
 E. Blade Adjustment..... 5-3

6. Operation

Powering Up the Machine 6-1
 Operating the Machine 6-1
 Manual Operation 6-1
 Programming the Machine 6-1
 Entering a Program 6-1

7. Operator Maintenance

Caring for the ProCut 20P.....7-1
 Cleaning The Paper Cutter7-1
 Cut Stick Rotation and Replacement.....7-1
 Blade Replacement.....7-1

8. Function Values

Changing Function Values 8-2

MyBinding.com
 5500 NE Moore Court
 Hillsboro, OR 97124
 Toll Free: 1-800-944-4573
 Local: 503-640-5920



MyBinding.com
5500 NE Moore Court
Hillsboro, OR 97124
Toll Free: 1-800-944-4573
Local: 503-640-5920

1. SAFETY

Your safety, as well as the safety of others, is important. Before you install or use the machine, read and follow all the safety notices carefully in this chapter. In this instruction manual, and on the machine, you will find important safety notices related to the use of the product. Observe all the safety information provided.

Read all of the instructions and save these instructions for further use. Also make sure you have been fully trained before operating.

The safety alert symbol precedes each safety notice in this manual. The symbol indicates a potential personal safety hazard to you or others.

This safety alert symbol indicates a potential electrical shock. It warns you not to open the machine and expose yourself to hazardous voltage.

The following warnings are found on the equipment.

<p>READ the instruction manual and SAFETY PRECAUTIONS, before operating.</p> <p>LEER detenidamente el manual de instrucciones y LAS PRECAUCIONES DE SEGURIDAD antes de operar.</p> <p>LIRE le manuel d'instructions et LES AVERTISSEMENTS DE SÉCURITÉ avant l'utilisation.</p>	<p>CRUSH HAZARD – Keep hands from under knife and paper clamp. Use hand tools to load paper, and back gauge to push out trimmed stock.</p> <p>PELIGRO CRUSH - Mantenga las manos fuera de cuchillo y papel pinza. Utilice las herramientas de mano para cargar el papel, y el medidor de nuevo a empujar fuera de stock recortado.</p> <p>RISQUE D'ÉCRASEMENT - Gardez les mains loin de la lame du couteau et du pince-papier. Utilisez les outils pour charger le papier, et la butée arrière pour faire sortir le papier coupé.</p>	<p>DO NOT ALTER SAFETY MECHANISMS. They are for your protection.</p> <p>NO ALTERAR MECHANISMS SEGURIDAD. Ellos son para su protección.</p> <p>NE PAS MODIFIER LES MECANISMES DE SÉCURITÉ. Ils sont là pour votre protection.</p>
<p>DISCONNECT POWER before cleaning, servicing, adjusting, or lubricating.</p> <p>DESCONECTE LA CORRIENTE ELECTRICA antes de limpiar, ajuste o lubricación la maquina.</p> <p>DEBRANCHER avant le nettoyage, l'entretien, l'ajustement, ou avant la lubrification.</p>	<p>DO NOT OPERATE WITH MORE THAN ONE PERSON!</p> <p>NO OPERAR CON MÁS DE UNA PERSONA!</p> <p>NE PAS FAIRE FONCTIONNER AVEC PLUS D'UNE PERSONNE!</p>	<p>LASER RADIATION - Do not stare into beam, continued exposure may damage your eyes.</p> <p>RADIACION LASER - No mire directamente al rayo. La exposición prolongada puede dañar sus ojos.</p> <p>Radiation Laser - ne pas fixer le rayon lumineux, une exposition prolongée peut endommager vos yeux.</p>
<p>DO NOT OPERATE WITH ANY GUARDS REMOVED!</p> <p>NO OPERAR SIN LAS GUARDIAS!</p> <p>NE PAS UTILISER SANS LES BARRIERES DE SÉCURITÉ!</p>	<p>ATTENTION\ATENCIÓN\ ATTENTION</p> <p>LASER RADIATION\RADIACION LASER\ RADIATIONS LASER</p> <p>DO NOT STARE INTO BEAM NO MIRAR DIRECTAMENTE AL RAYO\NE PAS FIXER LE RAYON LUMINEUX</p> <p>CLASS 2 LASER PRODUCT\ PRODUCTO LÁSER DE CLASE 2\ LASER DE CLASSE 2</p> <p>WAVELENGTH\ LONGITUD DE ONDA\ LONGUEUR D'ONDE : 650 +/- 40nm</p> <p>OPTICAL POWER\ POTENCIA ÓPTICA\ PUISSANCE OPTIQUE < 1mW</p> <p>IEC 60825-1: 2007-EN60825-1: 2007 ED20</p>	

READ the instruction manual and **SAFETY PRECAUTIONS**, before operating.

LEER detenidamente el manual de instrucciones y **LAS PRECAUCIONES DE SEGURIDAD** antes de operar.

LIRE le manuel d'instructions et **LES AVERTISSEMENTS DE SÉCURITÉ** avant l'utilisation.

DISCONNECT POWER before cleaning, servicing, adjusting, or lubricating.

DESCONECTE LA CORRIENTE ELECTRICA antes de limpiar, ajuste o lubricación la maquina.

DEBRANCHER avant le nettoyage, l'entretien, l'ajustement, ou avant la lubrification.

DO NOT OPERATE WITH ANY GUARDS REMOVED!

NO OPERAR SIN LAS GUARDIAS!

NE PAS UTILISER SANS LES BARRIERES DE SÉCURITÉ!

CRUSH HAZARD – Keep hands from under knife and paper clamp. Use hand tools to load paper, and back gauge to push out trimmed stock.

PELIGRO CRUSH - Mantenga las manos fuera de cuchillo y papel pinza. Utilice las herramientas de mano para cargar el papel, y el medidor de nuevo a empujar fuera de stock recortado.

RISQUE D'ÉCRASEMENT - Gardez les mains loin de la lame du couteau et du pince-papier. Utilisez les outils pour charger le papier, et la butée arrière pour faire sortir le papier coupé.

DO NOT ALTER SAFETY MECHANISMS. They are for your protection.

NO ALTERAR MECHANISMS SEGURIDAD. Ellos son para su protección.

NE PAS MODIFIER LES MECANISMES DE SÉCURITÉ. Ils sont là pour votre protection.

DO NOT OPERATE WITH MORE THAN ONE PERSON!

NO OPERAR CON MÁS DE UNA PERSONA!

NE PAS FAIRE FONCTIONNER AVEC PLUS D'UNE PERSONNE!



ATTENTION\ATENCIÓN\ ATTENTION

LASER RADIATION\RADIACION LASER\ RADIATIONS LASER

DO NOT STARE INTO BEAM NO MIRAR DIRECTAMENTE AL RAYO\NE PAS FIXER LE RAYON LUMINEUX

CLASS 2 LASER PRODUCT\ PRODUCTO LÁSER DE CLASE 2\ LASER DE CLASSE 2

WAVELENGTH\ LONGITUD DE ONDA\ LONGUEUR D'ONDE : 650 +/- 40nm

OPTICAL POWER\ POTENCIA ÓPTICA\ PUISSANCE OPTIQUE < 1mW

IEC 60825-1: 2007-EN60825-1: 2007 ED20

WARNINGS

- Do not attempt to service or repair the machine.
- Do not open the machine. There are no serviceable parts inside. Refer service to qualified service personnel.
- Do not attempt to modify this equipment.
- Do not connect to an electrical supply or attempt to operate until you have completely read these instructions. Maintain these instructions in a convenient location for future reference.
- Entrapment hazard. Do not operate when alone. More than one person is required to be in the area when operating the machine.
- To guard against injury, the general safety precautions must be observed when installing and using the machine.



WARNINGS (CONT'D)

- Consider the work area. A cluttered work area can lead to accidents. The machine must be placed on a sturdy level floor surface. Allow sufficient access to the front, back, and sides. Keep the work area well lit.
- Plastic bags must be kept out of reach of children.

Failure to observe these warnings could result in severe personal injury or death.

CAUTIONS

Caution indicates a hazardous situation which, if not avoided, could result in minor or moderate injury or cause damage to the machine.

GENERAL

- Keep fingers, hands clothing, jewelry, and long hair away from the front of the Working Table, Clamp, and Cutting Blade.
- Use only sufficiently stable and compatible stands. Make certain the equipment is installed securely and cannot fall down.
- Do not use the machine for other than its intended purpose.
- Avoid quick stops, excessive force and uneven floor surfaces when moving the machine.
- The cutter and stand are separate components. The cutter and stand will need to be lifted and moved separately.
- Do not defeat or remove electrical and mechanical safety equipment such as interlocks, shields and guards.
- Do not insert objects unsuitable for the purpose of this machine or expose the equipment to liquids.
- The cabinet should remain locked at all times and only be opened by approved personnel.
- Do not store flammable items in the cabinet.

Before you operate this machine, it is important that you read and understand the entire contents of these instructions.

ELECTRICAL

The machine should be connected only to a source of power as indicated in these instructions and on the nomenclature plate located on the side of the machine. Contact an electrician should the attachment plug provided not match the receptacles at your location. After plugging in, check that the power cord does not create a tripping hazard.



WARNING: Do not attempt to service or repair. Failure to observe this warning could result severe personal injury or death.

Disconnect the plug from the receptacle and contact your dealer or distributor, or GBC Technical Service at 1-800-723-4000, when one or more of the following has occurred.

- The power supply cord or attachment plug is damaged.
- Liquid has been spilled into the machine.
- The machine is malfunctioning.
- The machine does not operate as described in these instructions.



Opening the machine exposes you to hazardous voltage, which can seriously hurt or kill you. There are no user serviceable parts inside. Refer service to qualified service technician.

CAUTION: The receptacle must be located near the equipment and must be easily accessible.

Disconnect the attachment plug from the receptacle to which it is connected and keep the power supply cord in your possession when moving.

GBC TECHNICAL SERVICE

To order replacement accessories, service, parts, or an Equipment Maintenance Agreement, please contact GBC Technical Service and Support at:

UNITED STATES

ACCO Brands
GBC Technical Service and Support
4 Corporate Drive
Lake Zurich, IL 60047-8997
www.gbconnect.com

1-800-723-4000

CANADA

Ontario and Quebec – 1-800-268-3310
All other Provinces – 1-800-268-3447
Local 905-595-3100
Callcentre@GBCCanada.com

MEXICO

(55) 1500 5778
Lada SIN costo: 01 800 759 6825
serviciotecnico@acco.com.mx



2. WARRANTY

LIMITED ONE YEAR PARTS, 90 DAYS LABOR WARRANTY; USA, MEXICO, AND CANADA

ACCO Brands USA LLC, ACCO Brands, 4 Corporate Drive, Lake Zurich, IL 60047 (in Mexico, ACCO Brands Mexicana, Neptuno 43, Fraccionamiento Nueva Industrial Vallejo México 07700 D.F. México), (in Canada, ACCO Brands Canada Inc., 7381 Bramalea Road, Mississauga ON L5S1C4) (each, respectively, “ACCO Brands”) warrants to the original purchaser that this ACCO Brands product is free from defects in workmanship and material under normal use and service for a period of: one (1) year for parts and ninety and (90) days for labor after purchase.

ACCO Brands’ obligation under this warranty is limited to replacement or repair, at ACCO Brands’ option, of any warranted part found defective by ACCO Brands without charge for material or labor. Any replacement, at ACCO Brands’ option, may be the same product or a substantially similar product that may contain remanufactured or refurbished parts. This warranty shall be void in the following circumstances:

- (i) if the product has been improperly installed or misused,
- (ii) if the product has been damaged by negligence or accident, or
- (iii) if the product has been altered by anyone other than ACCO Brands or ACCO Brands’ authorized agents.

Without limiting the generality of the previous paragraph, ACCO Brands’ obligation under this limited warranty does not include:

- (a) damage caused to the rollers by knives, razors, or other sharp tools; by any foreign objects falling into the working area of the laminator; or by cleaning the laminator with solutions or materials that harm its surfaces;
- (b) damage caused by adhesives; nor
- (c) damage caused by lifting, tilting or attempting to position the laminator other than rolling it on its castors across even surfaces. For warranty execution, please contact ACCO Brands at:
800-723-4000 or www.gbconnect.com in the USA
800-263-1063 or www.gbcanada.com in Canada
(55) 1500 5578 or www.accomexico.mx in Mexico

TO THE EXTENT ALLOWED BY APPLICABLE LAW, THIS WARRANTY IS IN LIEU OF ALL OTHER EXPRESSED WARRANTIES. REPRESENTATIONS

OR PROMISES INCONSISTENT WITH OR IN ADDITION TO THIS WARRANTY ARE UNAUTHORIZED AND SHALL NOT BE BINDING ON ACCO BRANDS. TO THE EXTENT PERMITTED BY APPLICABLE LAWS, ANY IMPLIED WARRANTIES (IF APPLICABLE) ARE LIMITED IN DURATION TO THE DURATION OF THIS WARRANTY. SOME STATES AND JURISDICTIONS DO NOT ALLOW LIMITATIONS ON HOW LONG AN IMPLIED WARRANTY LASTS, SO THE ABOVE LIMITATION MAY NOT APPLY TO YOU. TO THE EXTENT PERMITTED BY APPLICABLE LAW, IN NO EVENT SHALL ACCO BRANDS BE LIABLE FOR ANY SPECIAL, INCIDENTAL, PUNITIVE, EXEMPLARY, CONSEQUENTIAL OR SIMILAR DAMAGES, WHETHER OR NOT FORESEEABLE. SOME STATES AND JURISDICTIONS DO NOT ALLOW THE EXCLUSION OR LIMITATION OF SPECIAL, INCIDENTAL, PUNITIVE, EXEMPLARY, CONSEQUENTIAL, OR SIMILAR DAMAGES, SO THE ABOVE EXCLUSION OR LIMITATION MAY NOT APPLY TO YOU.

FOR CONSUMERS WHO HAVE THE BENEFIT OF CONSUMER PROTECTION LAWS OR REGULATIONS IN THEIR JURISDICTION OF PURCHASE OR, IF DIFFERENT, IN THEIR JURISDICTION OF RESIDENCE, THE BENEFITS CONFERRED BY THIS WARRANTY ARE IN ADDITION TO ALL RIGHTS AND REMEDIES CONVEYED BY SUCH CONSUMER PROTECTION LAWS AND REGULATIONS.

To the extent permitted by law, this warranty is not transferable and will automatically terminate if the original product purchaser sells or otherwise disposes of the product.

This warranty gives you specific legal rights. Other rights, which vary from jurisdiction to jurisdiction, may exist. In addition some jurisdictions do not allow (i) the exclusion of certain warranties, (ii) limitations on how long an implied warranty lasts and/or (iii) the exclusion or limitation of certain types of costs and/or damages, so the above limitations may not apply.

MyBinding.com
5500 NE Moore Court
Hillsboro, OR 97124
Toll Free: 1-800-944-4573
Local: 503-640-5920



MyBinding.com
5500 NE Moore Court
Hillsboro, OR 97124
Toll Free: 1-800-944-4573
Local: 503-640-5920

3. SPECIFICATIONS

Model	ProCut 20P
Control	Programmable
Minimum Cut Length	1.19 in. (30 mm)
Maximum Cut Length	20.43 in. (519 mm)
Maximum Cut Thickness	2.5 in. (64 mm)
Maximum Cut Width	20.43 in. (519 mm)
Dimensions:	
• Width	34.5 in. (876 mm)
• Height	52.5 in. (1334 mm)
• Depth	45.5 in. (1156 mm)
• Work Table Height	39.5 in. (1003 mm)
Weight	419 lbs. (190 kg).
Electrical Requirements:	
• Voltage	208-240V 60 Hz
• Current	8A
• Power	1400 Watts
• Receptacle	NEMA 6-15P
Cycle Time	Operating time = 7 seconds Rest time = 3 seconds
Paper Press Method/Clamp	Automatic
Paper Pusher/Back Gauge	Automatic

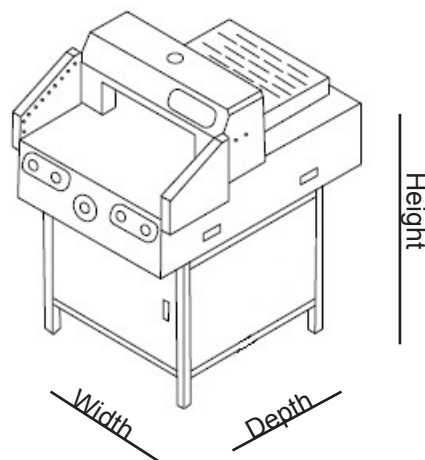

Figure 1. ProCut 20P Dimensions

MyBinding.com
 5500 NE Moore Court
 Hillsboro, OR 97124
 Toll Free: 1-800-944-4573
 Local: 503-640-5920



FCC CLASS A NOTICE

This device complies with Part 15 of the FCC Rules. Operation is subject to the following two conditions:

- This device may not cause harmful interference.
- This device must accept any interference received, including interference that may cause undesired operation.

Note: This equipment has been tested and found to comply with the limits for a Class A digital device, pursuant to Part 15 of the FCC rules. These limits are designed to provide reasonable protection against harmful interference when the equipment is operated in a commercial environment. This equipment generates, uses and can radiate radio frequency energy and, if not installed and used in accordance with the instruction manual, may cause harmful interference to radio communications. Operation of this equipment in a residential area is likely to cause harmful interference in which case the user will be required to correct the interference at his own expense.

CANADA CLASS A NOTICE - AVIS CANADA, CLASSE A

This Class A digital apparatus complies with Canadian ICES-003.

Cet appareil numérique de la classe A est conforme à la norme NMB-003 du Canada.

MODIFICATIONS

Any modifications made to this device that are not approved by ACCO Brands may void the authority granted to the user by the FCC and/or by Industry Canada to operate this equipment.

Toutes modifications apportées à ce dispositif et non approuvées par ACCO Brands annuleront le droit accordé à l'utilisateur par le FCC et/ou par Industrie Canada de faire fonctionner cet équipement.

MyBinding.com
5500 NE Moore Court
Hillsboro, OR 97124
Toll Free: 1-800-944-4573
Local: 503-640-5920

4. INSTALLATION

 **WARNING:** Do not attempt to service or repair the machine. Failure to observe this warning could result in severe personal injury or death.

Disconnect the plug from the receptacle and contact GBC Technical Service when one or more of the following has occurred.

- The power supply cord or attachment plug is damaged.
- Liquid has been spilled into the machine.
- The machine is malfunctioning.
- The machine does not operate as described in these instructions.

GBC TECHNICAL SERVICE

United States
1-800-723-4000

Canada
Ontario and Quebec – 1-800-268-3310
All other Provinces – 1-800-268-3447
Local 905-595-3100

Mexico
(55) 1500-5778

PRIOR TO INSTALLATION

Inspect the crate and machine for damage. Shipping damage should be brought to the immediate attention of the delivering carrier.

 **WARNING:** Do not attempt to move the machine across anything other than a flat, level surface without trained and qualified riggers. You can be severely injured or crushed.

The ProCut 20P Series Cutter is a large and heavy piece of equipment. It is not designed to be tipped up or tipped sideways in anyway.

Prepare the site:

1. Allow enough room to access all sides of the machine. Refer to the illustration on the next page.
2. Ensure the floor is stable and a flat surface capable of supporting the weight of the machine and any materials. All four foot pads should be able to be positioned completely on a level and smooth surface.

INSTALLATION

There are no operator serviceable parts to the machine other than periodic cleaning. Refer to the Operator Maintenance chapter.

During installation, observe the safety regulations applicable for your country.

 **WARNING:** A trained GBC Technician **MUST** install the machine for the first time. Failure to observe this warning could result in severe bodily injury or death.

CAUTION: Do not attempt to install the machine yourself for the first time. You could damage the machine.

MyBinding.com
5500 NE Moore Court
Hillsboro, OR 97124
Toll Free: 1-800-944-4573
Local: 503-640-5920



LOCATION

The ProCut 20P should be located in a space that allows adequate room to operate the machine. Allow at least six inches behind the machine. It is recommended that a media table be used to stage the sheets to be cut. A second media table is recommended for finished material. Keep the working area of the cutter free from clutter.

Avoid locating the cutter in a high traffic area. When not in use, the ProCut 20P can be unplugged.

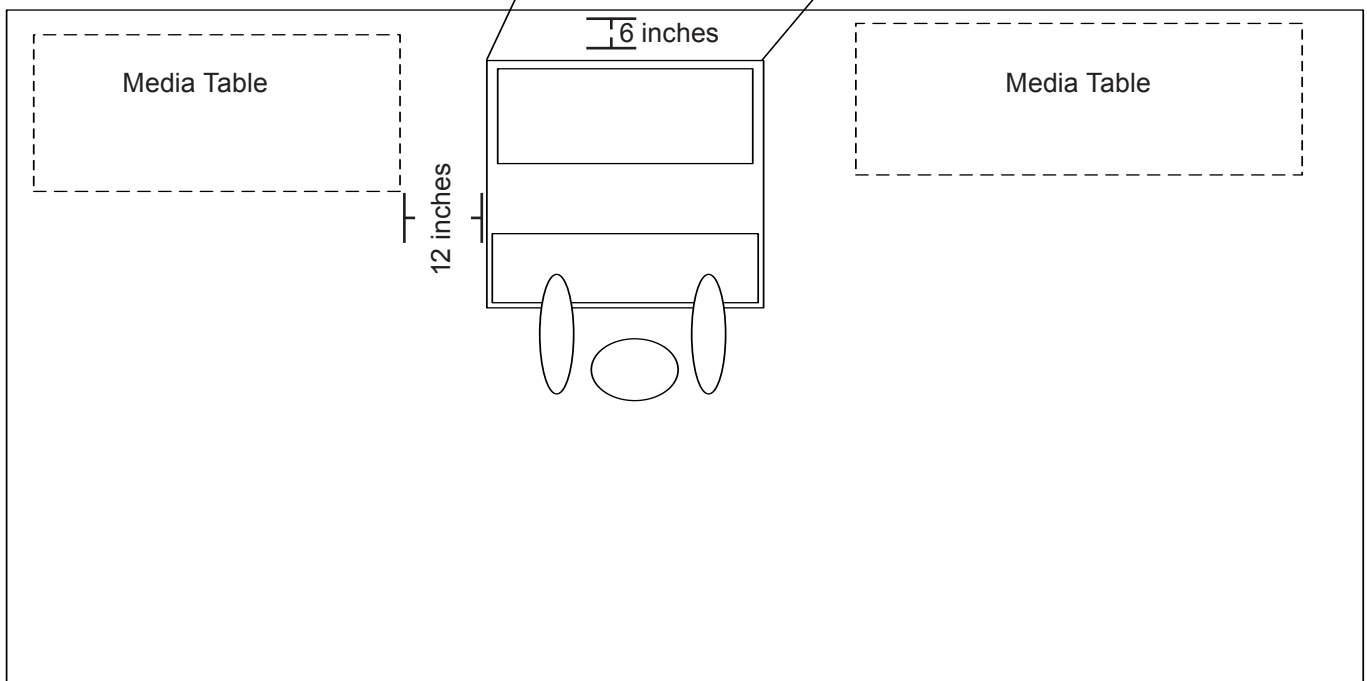
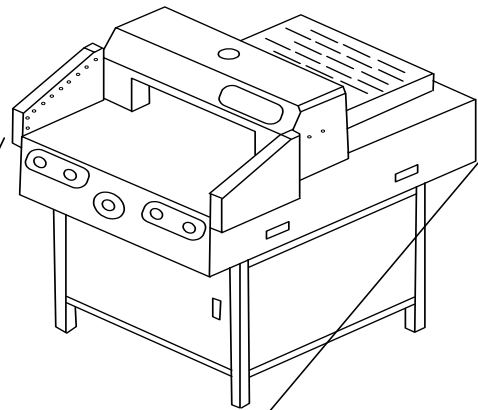

Figure 2. ProCut 20P Location

5. FEATURE GUIDE

This chapter identifies the main components of the machine.

INFRARED SAFETY WALLS



Figure 3. Infrared Safety Walls

The side walls on the working table contain infrared sensors which prevent the machine from operating when the sensors are obstructed. If an obstruction occurs, up to 65mm above the working table, an alarm sounds and the cut and clamp functions will not operate.

JOGGING AID



Figure 4. Jogging Aid

The Jogging Aid is used to register the paper against the Back Gauge.

BACK GAUGE

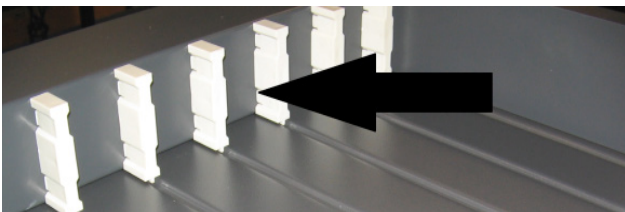

Figure 5. Back Gauge

Sets the proper position for cutting based on the values entered through the Control Panel. Media is then pushed against the Back Gauge using the Jogging Aid, to ensure a straight and accurate cut. Laser Cut Line

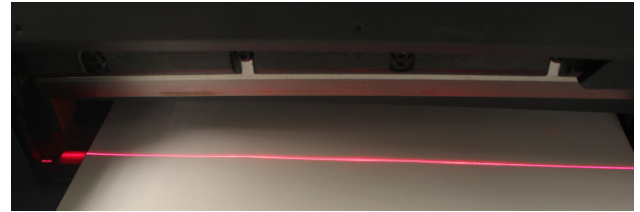

Figure 6. Red LED Laser Cut Line

The cut line, as shown in the photo above, is visible only when the machine is turned ON. The line indicates where the paper stack will be cut.

THE CLAMP & CUTTING BLADE

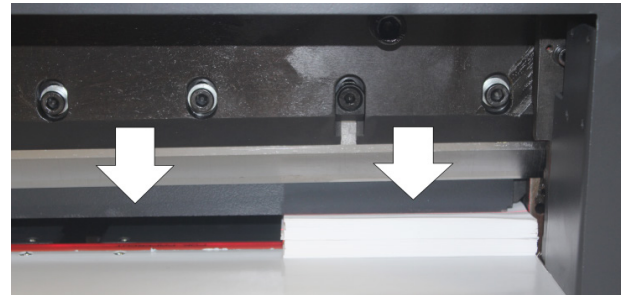

Figure 7. The Clamp (dark grey) and Cutting Blade

The Clamp activates first, pressing and holding down the media to ensure a clean cut. The Cutting Blade then cuts the stack. The blade should be sharpened or replaced every 2000 – 3000 cuts based on 20 lb. bond paper. Cutting Blades can be sharpened multiple times but it is recommended not to remove more than 8mm off the blade. The number of times you can sharpen the blade will depend on the types of media being cut.

CUT STICK

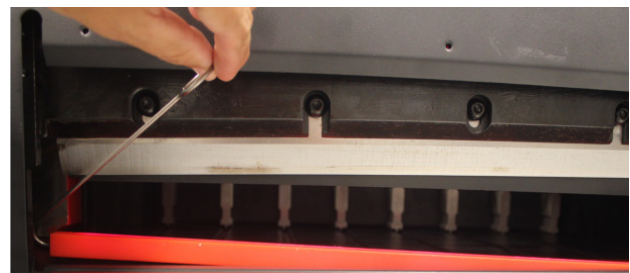

Figure 8. Cut Stick (red) and Removal Tool

The Cut Stick provides a clean cut as the Cutting Blade makes contact with it. The Cut Stick can be rotated to provide eight cutting surfaces.



WARNING: Keep hands and fingers away from the Clamp and Cutting Blade. Failure to observe this warning could result in severe personal injury.

CONTROL PANEL

In addition to the manual cut settings, the ProCut 20P can be programmed for in front and behind the blade cutting. Up to 80 programs, containing 99 steps each, can be stored for reuse.

The Control Panel includes an LCD display and keypad. The LCD shows the current and programmed settings of the cutter and the keypad is used to set up and program the cutting programs.

A. LCD DISPLAY

The display shows the current settings of the machine. The values shown can be displayed in millimeters or inches.

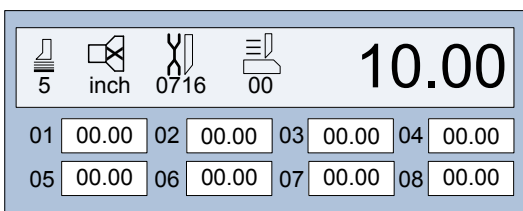

Figure 9. Rendering of LCD Display

CLAMPING FORCE:



Indicates the amount of pressure applied to the media. The pressure can be set from 1 (highest) to 9 (lowest) with the default being 5. You must be in the Clamping Force setting screen to adjust the pressure.

SAFETY CURTAIN ALARM:



Indicates whether the alarm buzzer is enabled or disabled.

REBLADING MODE:



Used when changing the blade.



WARNING: Blade removal should only be done by a GBC Technician. Failure to observe this warning could result in severe personal injury.

BEHIND THE BLADE:



Cut value is measured from behind the blade to the Back Gauge.

IN FRONT OF THE BLADE:



Cut values are measured by the amount of media the Back Gauge pushes in front of the blade from the previous cut.

BACK GAUGE VALUE:

The numeric value displayed is the current position of the Back Gauge.

PROGRAMMING VALUES:

Displays the programmed cuts entered for each step.

COUNT VALUE:

Provides the total cuts performed during the lifetime of the machine.

B. KEYPAD

The keypad is used to:

- Set the cutting size when operating in manual mode
- Change cutter settings
- Select or create programs



Figure 10. Keypad

Use the numeric keypad to enter the cut values in manual mode or when entering programs. To add a decimal, press the decimal button.

When display is in menu mode, the Up and Down arrow buttons are used to scroll through the menu and to increase or decrease selected values.

SET:

Use the Enter button to access the menu mode. Once in menu mode, use the numeric buttons to set the value when programming or changing cutter settings.

CANCEL:

The Cancel button is used to:

- Delete current values
- Return to the home screen from the menu mode
- Stop a warning condition

C. OPERATION BUTTONS

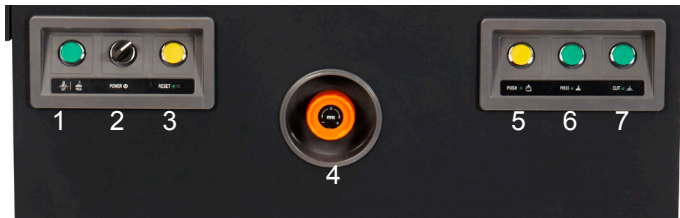

Figure 11. Operation Buttons on Machine Front

1. CLAMP CUT

This button must be pressed simultaneously with *either* the Clamp or Cut button.

2. ON/OFF SWITCH

The On/Off Switch must be in the ON position to supply power to the machine. When the machine is not in use, switch to the OFF position.

3. RESET

This button resets the Blade and Back Gauge to the default position. When the machine is initially turned ON, the Reset button must be pressed before the blade will cycle.

4. BACK GAUGE CONTROL DIAL

Used to move the back gauge. Turn left to move forward or right to move backward. Continuously holding in one direction will move the back gauge more quickly for larger adjustments.

5. PUSH

Use the push button to move the cut sheets out from under the clamp and blade. This is a safety feature to keep your hands away from the clamp and blade.

6. CLAMP

Press the Clamp and Clamp Cut buttons simultaneously to engage the Clamp.

7. CUT

Press the Cut and Clamp Cut buttons simultaneously to engage the Blade.

D. CIRCUIT BREAKER

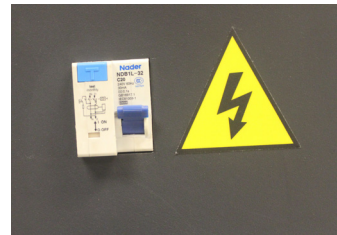

Figure 12. Circuit Breaker

If the machine experiences an overload, or short circuit, the Circuit Breaker will trip removing power from the machine. If this happens, confirm that the switch is in the OFF position, reset the Circuit Breaker, then move the switch to the ON position to apply power to the machine.

E. BLADE ADJUSTMENT



Figure 13. Blade Adjustment Hole and Hex Wrench

In the event the Blade is not cutting through the entire stack, the cut stick needs to be rotated. See “Cut Stick Rotation and Replacement” If after rotating the cut stick the Blade is still not cutting through the entire stack, then adjust the depth of the Blade.

Insert the 6mm Hex wrench into the blade adjustment hole and rotate clockwise to lower the blade. Refer to “Blade Depth Adjustment” for more information.

MyBinding.com
 5500 NE Moore Court
 Hillsboro, OR 97124
 Toll Free: 1-800-944-4573
 Local: 503-640-5920



MyBinding.com
5500 NE Moore Court
Hillsboro, OR 97124
Toll Free: 1-800-944-4573
Local: 503-640-5920

6. OPERATION

The ProCut 20P Paper Cutter follows standard SGS safety design specifications. The infrared photoelectric protection and two hand operation provides operators with more safety.

WARNING: This machine is designed for one person operation only. The operator must use both hands to operate the cutter. Failure to observe this warning could result in severe personal injury.

The ProCut 20P Paper Cutter is ideal for small to medium sized operations, to cut stacks of photocopies, printed materials, books, pictures, documents, and other non-metal materials to specified sizes.

CAUTION: Do not cut staples, paper clips, or other metal items with the cutter. Failure to observe this caution can damage the Cutting Blade.

Note: Grease from the Cutting Blade may transfer to the media when using the machine the first time. It is recommended to cut scrap media until the grease is no longer being transferred.

POWERING UP THE MACHINE

When the machine is powered on, the LCD Display illuminates. The Control Panel shows the machine's current condition.

1. Plug the power cord into an approved electrical outlet.
2. Move the Circuit Breaker, on the machine, to the up position.
3. Turn the switch to the ON position.

OPERATING THE MACHINE

After powering on the machine the word RESET appears on the LCD. Press the yellow **Reset** Button to set the Cutting Blade to the HOME position and calibrate the Back Gauge by returning to the home position and returning to the last used numeric setting.

Place the media on the Working Table and use the Jogging Aid to push the leading edge against the Back Gauge and align the sheets.

Using both hands, simultaneously press and hold the **Clamp Cut** and **Cut** buttons until it finishes cutting.

MANUAL OPERATION

1. Using the Keypad, enter the length of the cut.
2. Press **Enter**.

PROGRAMMING THE MACHINE

The ProCut 20P can be programmed for in front and behind the blade cutting. Up to 80 programs, containing 99 steps each, can be stored for reuse.

There are two modes:

- Front Blade
- Behind Blade

ENTERING A PROGRAM

1. Power up the machine.
2. Press the yellow **Reset** Button.
 - The Home screen is displayed on the LCD.

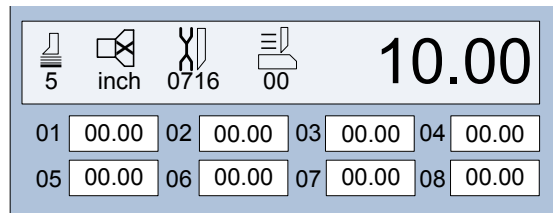

Figure 14. Rendering of Home Screen

3. To select the menu mode, press **SET** on the Keypad.
4. Press the **Up** or **Down arrow** for your desired mode, which is displayed on the LCD:
 - Behind Blade
 - Front Blade
5. Press **ENTER** on the Keypad.
 - Double 00 flashes.

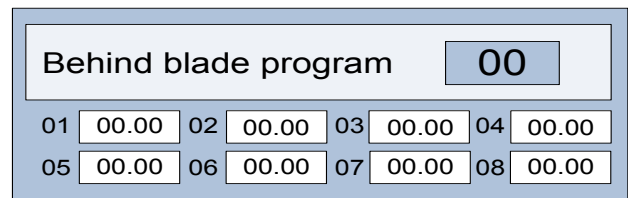

Figure 15. Pressing Enter on the Keypad

6. Press the **Up** or **Down arrow** buttons to select a program number 00 - 80.
7. Press **ENTER** to select the program.
 - The LCD displays the program number and cut values associated with the program. The first cut is highlighted.

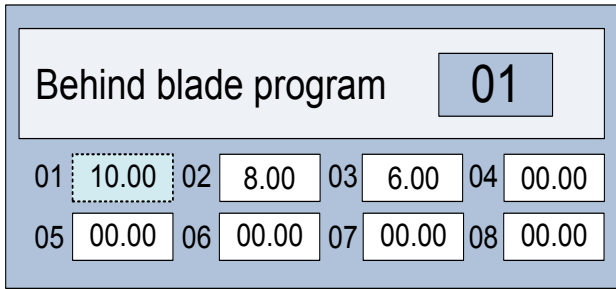

Figure 16. Rendering of Sample Program

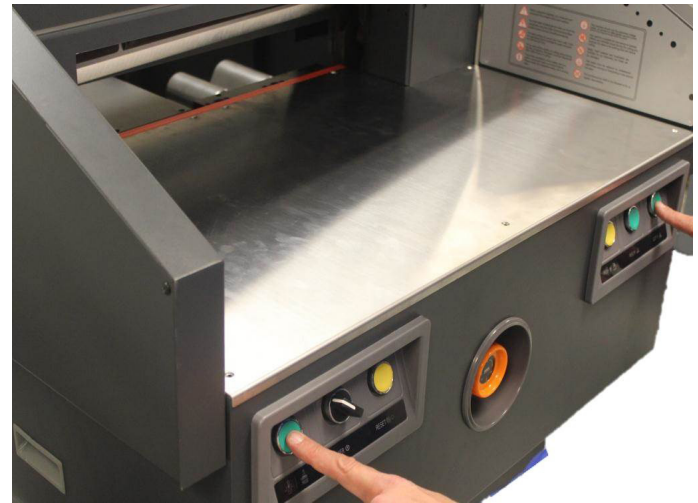
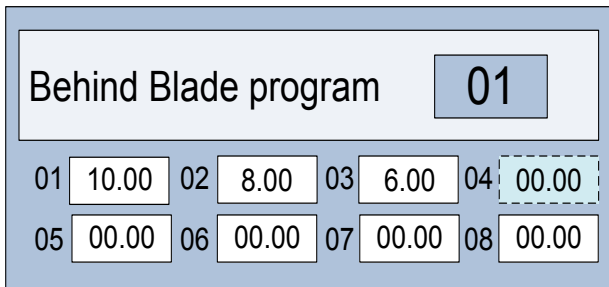

Figure 18. Operating the Machine

8. Using the Keypad, enter the value for the first cut.
 - Use the **Down arrow** to proceed to and enter the next cut value.
 - Continue this process until all cut values are entered.
9. After the last cut value has been entered, key in a value of 0.00. This signifies the end of your program and will return the Back Gauge to your first cut value position.

Figure 17. 00 Signifies End of Program



10. Press the **Enter** button once to signify program is complete and press **Enter** again to return the machine to the home screen and auto setup for the first cut of your program.
 - The first step is highlighted.
 - You are now ready to begin your job.
11. Make the first cut by simultaneously pressing the **Clamp Cut** and **Cut** buttons until it finishes cutting.

- Once all cuts in the program have been completed, the Back Gauge and LCD return to the first step in the program.
12. Press the **Set** button to exit the program.
 13. Press the **arrow** to select the mode used in the program and press the **Enter** button.
 - The program number blinks.
 14. Use the **Up** or **Down arrow** to select program 00.
 15. Press the **Enter** button.
 16. Press the “**C**” button.
 - The cutter is back in manual mode.

MyBinding.com
 5500 NE Moore Court
 Hillsboro, OR 97124
 Toll Free: 1-800-944-4573
 Local: 503-640-5920

7. OPERATOR MAINTENANCE

CARING FOR THE PROCut 20P

The only maintenance required by the operator is to perform what is described in this section. Perform *only* the routine maintenance procedures referred to in these instructions.

WARNINGS:

- Before performing maintenance on the machine, turn the Circuit Breaker and Switch to OFF.*
- Do not attempt to repair the machine. Refer service to qualified service personnel.
- Do not lift, tilt, or attempt to move the machine. You can be severely injured or crushed.

Failure to observe these warnings could result in severe personal injury or death.

*If rotating or replacing the Cut Stick, see the instructions, shown below, before turning the machine OFF.

CAUTIONS:

- Do not place materials on the table or near the Cutting Blade other than paper.
- Do not cut through metal objects such as paper clips or staples.
- Do not allow foreign objects to fall into the working area of the machine.

Failure to observe these cautions could result in damage to the machine.

CLEANING THE PAPER CUTTER

At the end of the day or project, clean up all waste and extra scraps off the working table.

CUT STICK ROTATION AND REPLACEMENT

The Cut Stick provides a clean cut as the Cutting Blade makes contact with it. When the Cut Stick is badly abraded and the paper is not cut cleanly, either rotate or replace the Cut Stick. The Cut Stick can be rotated to provide eight cutting surfaces.

1. Turn the Circuit Breaker and Switch to **OFF**.
2. Insert the Stick Removal Tool into the end of the Cut Stick and pull up.



Figure 19. Cut Stick Removal Tool

3. From the front of the machine, lift the Cut Stick out of the groove.

 **WARNING:** Keep fingers and hands clear of the Cutting Blade. Failure to observe these warnings could result in severe personal injury.

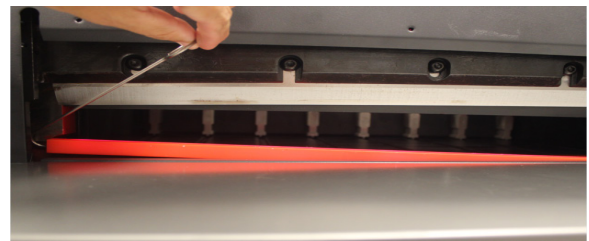

Figure 20. Cut Stick Removal

4. Do one of the following:
 - Rotate the Cut Stick
 - Turn the Cut Stick end-to-end
 - Replace the Cut Stick if all eight surfaces are abraded.
5. Put the Cut Stick back into the groove of the machine, making sure that both ends are level with the Working Table.
6. With the machine powered ON, press the **Reset** button.
 - The Cutting Blade and Clamp move to home position.

BLADE REPLACEMENT

The Cutting Blade can be sharpened for re-use or replacement. The blade should be sharpened professionally. It will need to be sharpened or replaced under any of the following conditions.

- Media is cut poorly
- Cutting sounds abnormal
- After approximately 2,000 cuts

CALL YOUR LOCAL SERVICE TECH OR DEALER FOR BLADE REMOVAL OR SHARPENING.

 **WARNING:** Do not attempt to service the Cutting Blade. Failure to observe these warnings could result in severe personal injury.

BLADE DEPTH ADJUSTMENT

If the Cutting Blade does not cut through the paper, the blade may need to be adjusted or the Cut Stick may need to be changed. See “Cut Stick Rotation and Replacement”.

The blade can be adjusted up to approximately .9 inch (23mm). Adjustment is made with a number 6mm hex wrench on the upper right corner of the machine above the Cutting Blade housing.

Insert a number 6mm hex wrench in the blade adjustment hole and turn the screw clockwise. Rotate 45 degrees, or a quarter turn, then check for proper cutting.

- Counter-clockwise raises the blade
- Clockwise lowers the blade



Figure 21. Blade Adjustment

At the end of its useful life, your product is considered to be Waste Electrical and Electronic Equipment (WEEE). As such, it is important to note that:

- WEEE is not to be disposed of as unsorted municipal waste. It is to be collected separately such that it can be disassembled so its components and materials can be recycled, re-used, and recovered (burned for energy content in electricity production).
- Public collection points have been set up by municipalities for the collection of WEEE, free of charge to you.
- Please return your WEEE to the collection facility nearest your home or office.
- If you have difficulty locating a collection facility, the retailer that sold you the product should accept your WEEE.
- If you are no longer in contact with your retailer, please contact ACCO for assistance with this matter.
- Recycling of WEEE is geared toward protecting the environment, protecting human health, preserving raw materials, improving sustainable development, and ensuring a better supply of commodities in the European Union. This will be achieved by retrieving valuable secondary raw materials and reducing the disposal of waste. You can contribute to the success of these goals by returning your WEEE to a collection facility.
- Your product is marked with the WEEE symbol (wheelie bin with an X through it). This symbol is to inform you that WEEE is not to be disposed of as unsorted municipal waste.

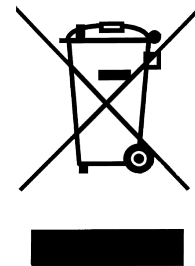

MyBinding.com
5500 NE Moore Court
Hillsboro, OR 97124
Toll Free: 1-800-944-4573
Local: 503-640-5920

8. FUNCTION VALUES

There are eight functions which are as follows:

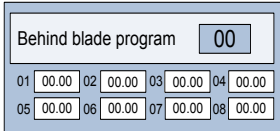
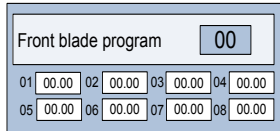
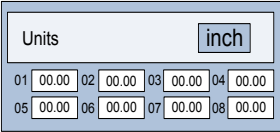
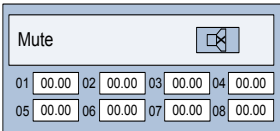
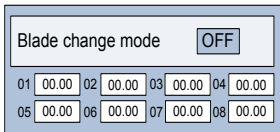
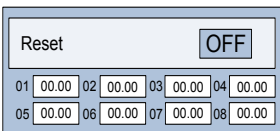
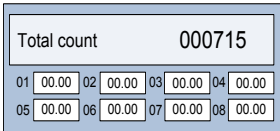
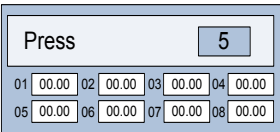
Function Name & Rendered Drawing	Description	When to Use
<p>Behind Blade Program</p> 	Behind Blade cutting used in program setup.	When doing large jobs with multiple cuts.
<p>In Front Blade Program</p> 	In Front Blade cutting used in program setup.	When doing large jobs with multiple cuts.
<p>Unit of Measurement</p> 	Measurements can be in millimeters or inches.	Use either option depending on personal preference.
<p>Buzzer Mode</p> 	Ability to turn on/off the audio warning for the Safety Curtain.	You are turning off an audible warning for a safety feature, use at your own discretion.
<p>Reblading Mode</p> 	Service mode used when replacing the blade.	CALL YOUR LOCAL SERVICE TECH OR DEALER FOR BLADE REMOVAL OR SHARPENING.
<p>Reset</p> 	Service adjustment to optimize performance.	Used by the Service Technician.
<p>Count Value</p> 	Provides the total cuts performed during the lifetime of the machine.	After approximately 2,000 cuts the blade should be sharpened.
<p>Clamping Force</p> 	Numeric value of pressure applied to the media by the Clamp.	When the paper is pulling out from under clamp during cutting process or if too much pressure being applied is leaving clamp marks on the media.



CHANGING FUNCTION VALUES

Once the Function is selected, enter the value by pressing the Up or Down arrow keys.

1. Press the **Set** button once to access the Functions. Use the **Up** or **Down arrows** to scroll through the Functions.
2. When the desired Function is highlighted on the LCD, press the **Enter** button again.
 - The value is highlighted.

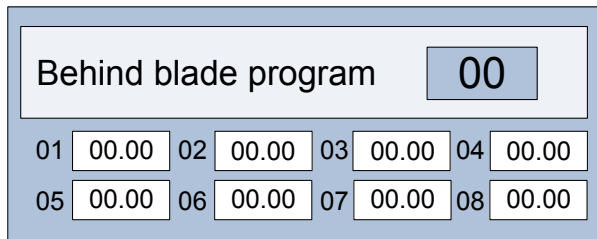

Figure 22. Value to Change

3. Press the **Up** or **Down arrow** keys to change the value.
 - Each time the arrow key is pressed the changed value is displayed.
4. Press **Enter** when your desired value is shown.

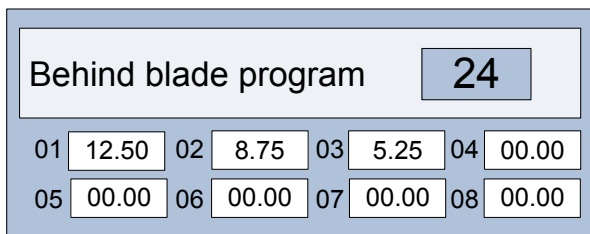

Figure 23. Value Highlighted

MyBinding.com
5500 NE Moore Court
Hillsboro, OR 97124
Toll Free: 1-800-944-4573
Local: 503-640-5920

MyBinding.com
5500 NE Moore Court
Hillsboro, OR 97124
Toll Free: 1-800-944-4573
Local: 503-640-5920



MyBinding.com
5500 NE Moore Court
Hillsboro, OR 97124
Toll Free: 1-800-944-4573
Local: 503-640-5920

© 2015 ACCO Brands. All rights reserved. ACCO® is a registered trademark of ACCO Brands. GBC® is a registered trademark of General Binding Corporation.

1729247 Rev. A 2015/03