

Ghent 36"x72" 3-Door Satin Aluminum Illuminated Headliner Corkboard

Instruction Manual



Provided by

MyBinding.com
When Image Matters.

Call Us at 1-800-944-4573

Message Center Instruction Sheet

For the most secure mounting of the unit, install all mounting screws directly to wall studs. When wall studs can not be used we recommend using hollow wall anchors.

The recommended mounting height of the unit is 78" from the floor to the top of the unit.

MyBinding.com
5500 NE Moore Court
Hillsboro, OR 97124
Toll Free: 1-800-944-4573
Local: 503-640-5920

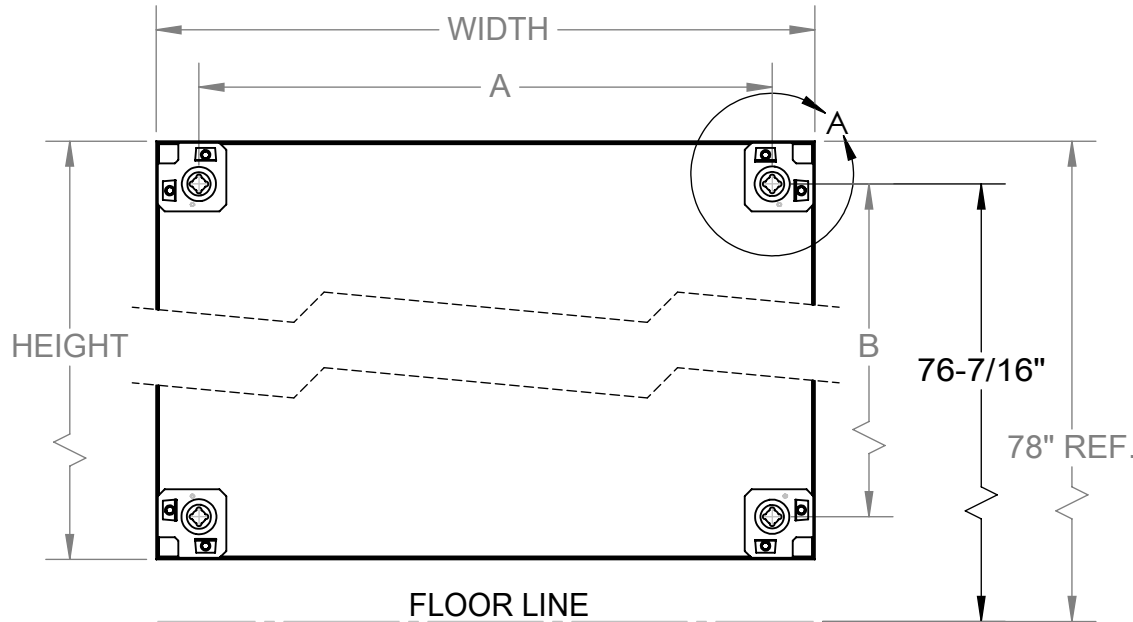

Mounting Instructions:

- 1.) Scribe a level line on the wall at 76-7/16"
- 2.) Space the holes using the attached charts.
- 3.) Drill and install the mounting hardware and allow the screw head to protrude 1/4" max from the wall.
- 4.) Hang unit onto protruding screw heads using the sheet metal brackets on the rear of the unit.

NOTE:

To mount a 96" long unit, use the "L"-hangers (provided) in addition to wall anchors (not provided) and follow the mounting instructions enclosed with the "L"-hangers.

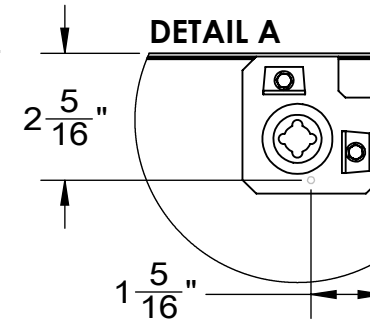

NOTE:

For permanent mounting, drill a 1/8" hole through the back of the sheet metal brackets. The hole should be located at 1-5/16" vertical & 2-5/16" horizontal. Fasten to the wall with 2" #8 self-tapping screws. (Before drilling through the face of the board make sure to score the board surface so that it doesn't get tangled in the screw.)

Unit Width	18"	24"	30"	36"	48"	60"	72"	96"
A	14- ¹³ / ₁₆ "	20- ¹³ / ₁₆ "	26- ¹³ / ₁₆ "	32- ¹³ / ₁₆ "	43- ¹⁵ / ₁₆ "	55- ¹⁵ / ₁₆ "	67- ¹ / ₁₆ "	92- ¹³ / ₁₆ "

Unit Height	24"	36"	48"
B	20- ⁷ / ₈ "	32- ⁷ / ₈ "	44- ¹ / ₁₆ "

****Important**:** Units with lighted headers require electrical installation by a licensed electrician. Consult your local electrical code to determine the correct method of installation.

The lamps have been mounted in the unit, but have not been wired.

Access to the lamps can be made by removing the rear panel of the header section of the unit.

****Important**:** Specific units that are designed for outdoor use are water-resistant, not water-proof. When being hung outdoors, unit should be under cover to prevent damage.

Message Center Instruction Sheet



MyBinding.com
5500 NE Moore Court
Hillsboro, OR 97124
Toll Free: 1-800-944-4573
Local: 503-640-5920

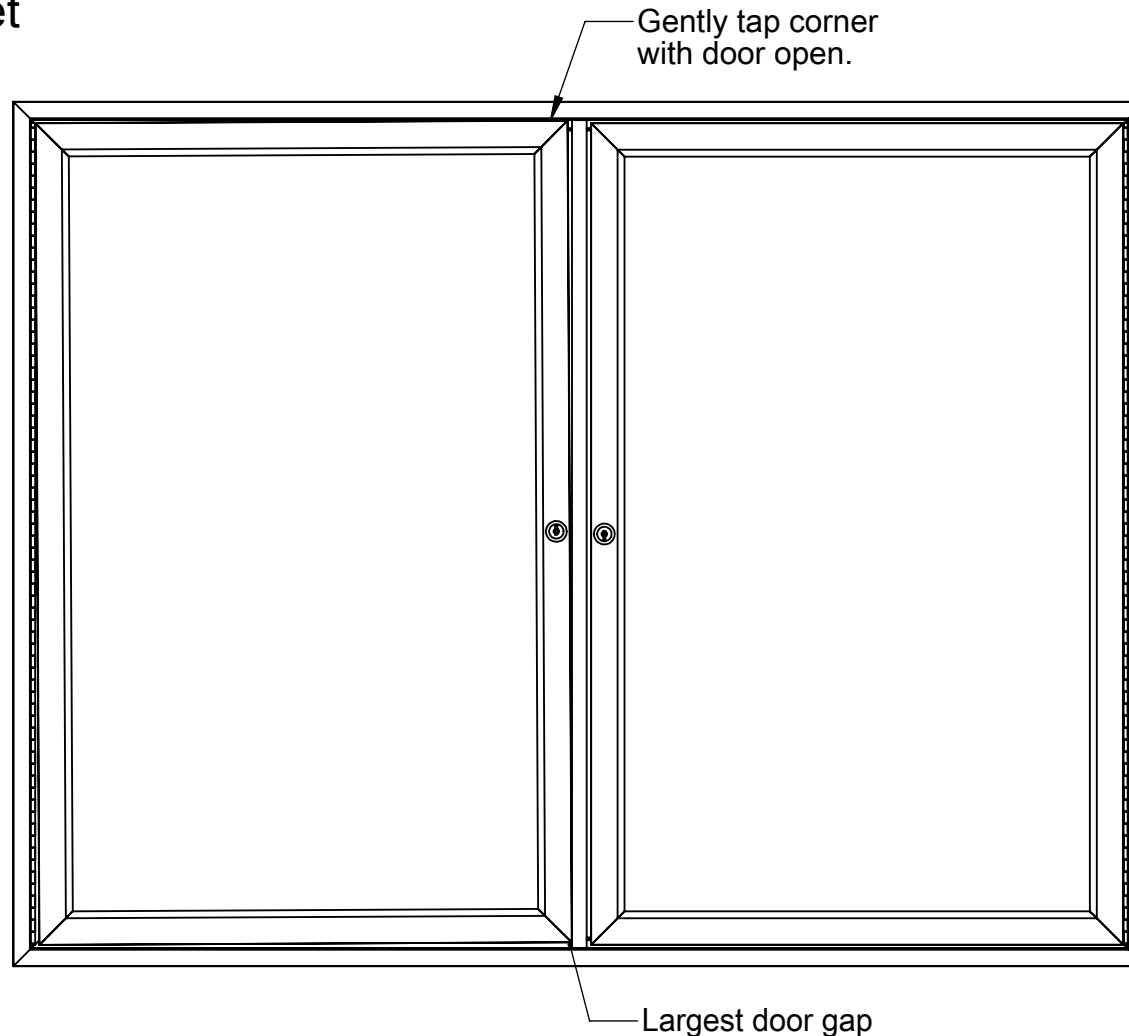

Your new Ghent Message Center has been assembled and inspected to Ghent's high quality standards. Occasionally during shipment, your message center's door(s) may shift. This shift results in an uneven gap between the door(s) and the body of your unit.

The uneven gap is easily remedied. Mount your unit per the instructions on page 1. Then simply open the affected door(s) and gently tap the door corner opposite the largest gap (see the figure above). When you tap the door, be sure to use a rubber mallet or a block of wood and a hammer so the door's finish is not marred. After you've tapped the door corner, close the door and inspect the surrounding gap. If needed repeat the tapping procedure.