



Javelin Series 2

Inspired Design – Precision Engineering

USER INSTRUCTIONS

Thank you for choosing the Keencut Javelin Series 2. Every effort has been made to bring you a precision engineered product with the promise of many years of valuable service. In order to obtain maximum benefit from your machine please read these instructions carefully. For advice and assistance or replacement parts please contact your distributor or Keencut.

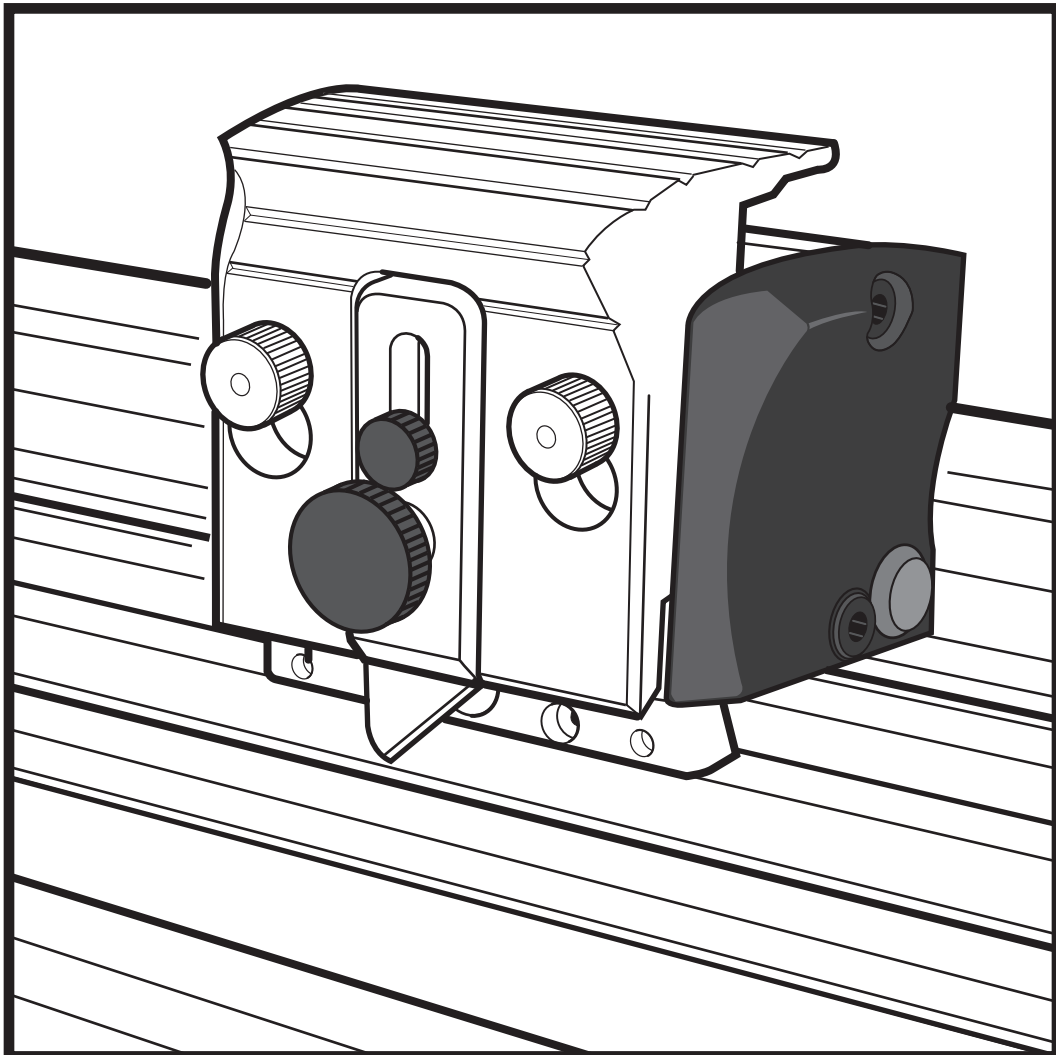

1 Contents

2 Safety & Preparation

- 2.1 Installation Recommendations
Safety

3 Set-up

- 3.1 Blades and blade holders
- 3.2 Changing the blade holder
- 3.3 Inserting the GRAPHIK Blade and setting the Depth

4 Operation

- 4.1 Cutting, Scoring hard plastics, Cutting PVC foamboards
- 4.2 Using the Rotary Cutter
- 4.3 Changing the Rotary Blade
- 4.4 Medium Duty Blade Holder

5 Maintenance

- 5.1 Cleaning and Lubrication - (warning note)
Adjusting the Cutting Head Sliding Bearings.

CHECKING THE FLAT SURFACE (TABLE TOP)

- **Please note!** It is essential that the cutter is used on a flat surface for accuracy. A warped or bowed table top can induce a twist or bend in the Cutter Bar resulting in a bowed cut.

SAFETY

- The blade must be removed before moving, cleaning or handling the cutter.
- Do not place your fingers near the blade when using the machine.
- Do not use the Cutter if there are any signs of damage to the Cutting Head or Cutter Bar Assembly.

BLADES AND BLADE HOLDERS

The Javelin is fitted with an all-new vertical action cutting head which reliably controls the blade depth and eliminates the need for heavy downward hand pressure when cutting tough materials such as PVC foamboard. Providing a smooth consistent cutting action on just about every flexible material used in the Graphics and Sign making Industries.

The JavelinCutter bar has been designed to cut a variety of boards to a thickness of 10mm (3/8") using standard Medium Duty utility blade. Materials to 13mm (1/2") can be cut using the GRAPHIK D 017 blade holder.

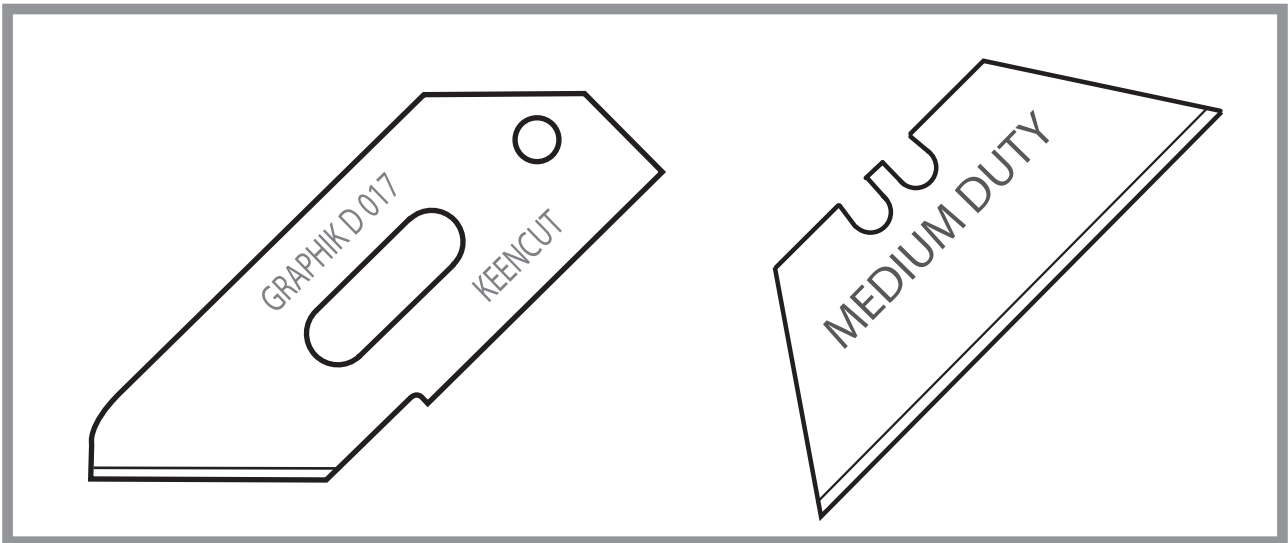

Consideration should be given to the toughness of the board being cut and the maximum depth of cut. It is recommended that heavy materials such as PVC foamboard should ideally be cut using the Graphik blade holder and to a maximum of 6mm (0.25") whereas, lighter materials like foam centred board can be cut up to the maximum cutting depth of the blade being used.

CHANGING THE BLADE HOLDER

Before removing a blade holder make sure the blade has been removed or guarded (dependant on type).

Loosen both of the small knurled knobs **A** by about two turns, raise the blade holder to align the knobs with holes in the blade holder then pull towards you to release. Reverse the procedure to attach a blade holder to the cutting head.

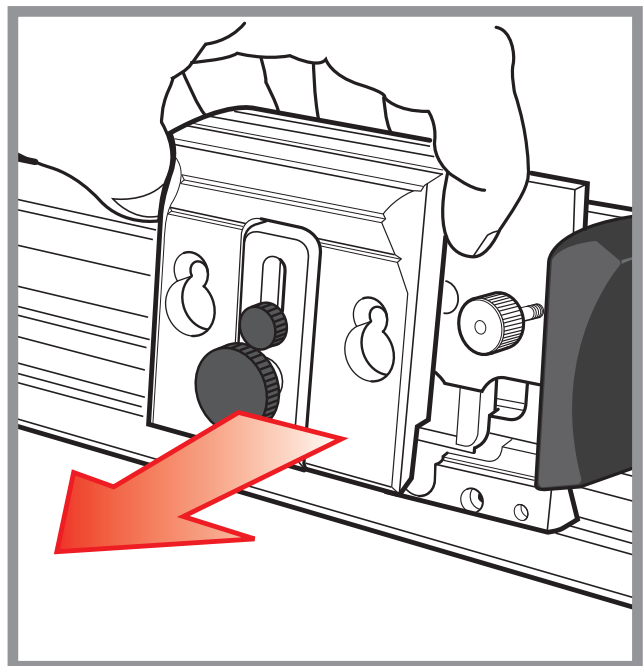
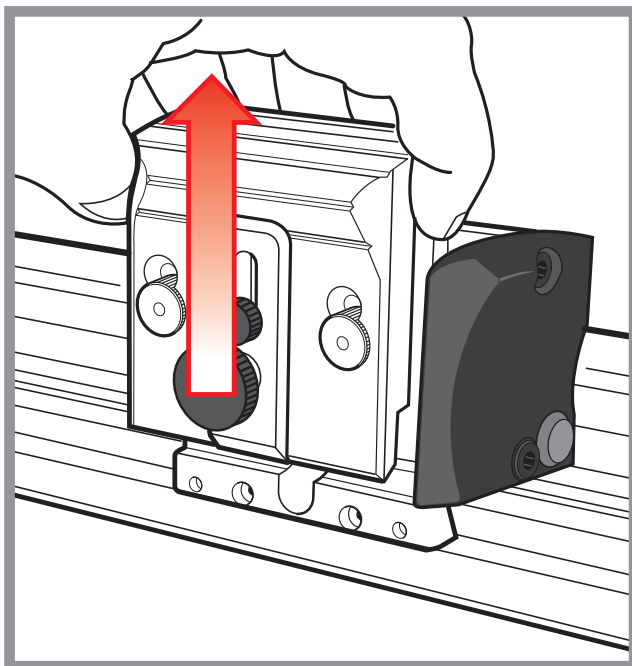
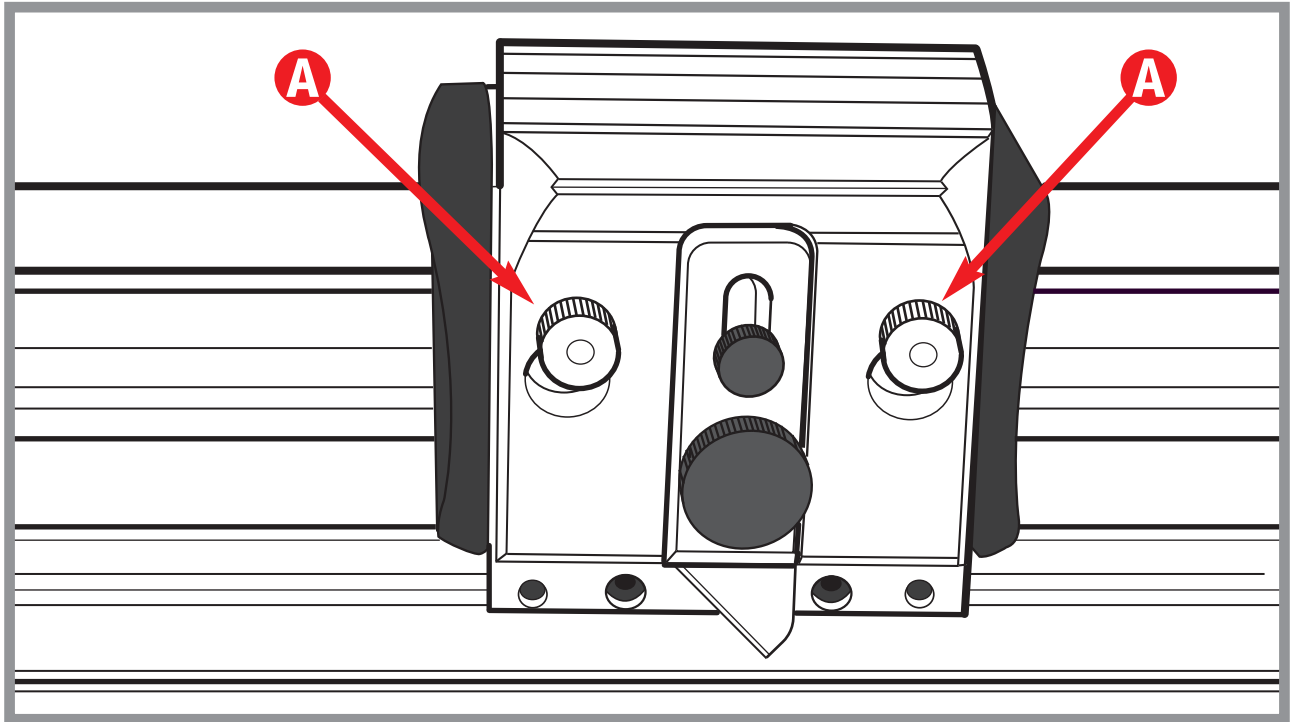

INSERTING THE GRAPHIK BLADE AND SETTING THE DEPTH

Detach the blade clamping plate **B** by removing the large black clamping screw **C**, if there is a blade already in the holder it will come away with the magnetic clamping plate **B**. You will notice the blade depth adjuster with the small black knob is free to slide along its slot and the raised pip on its underside locates in the small hole in the GRAPHIK blade.

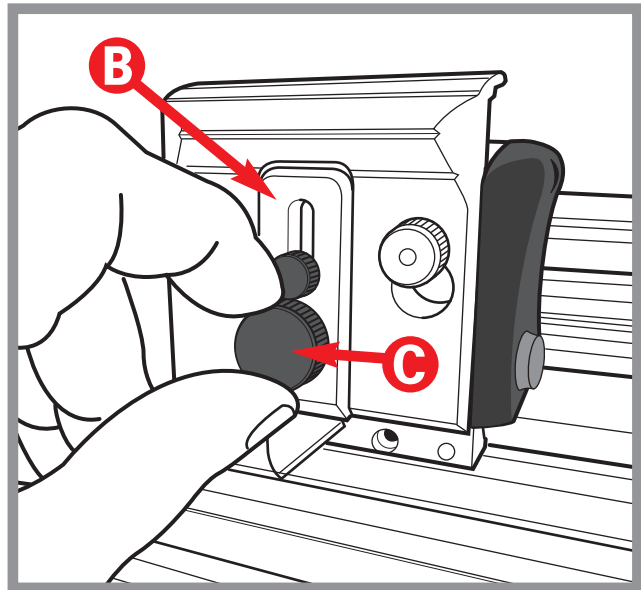

Ensure there is no debris on the underside of the clamping plate particularly around the magnet before fitting the new blade. The blade can be positioned on the clamping plate either way round enabling the blade to cut either left to right or right to left .

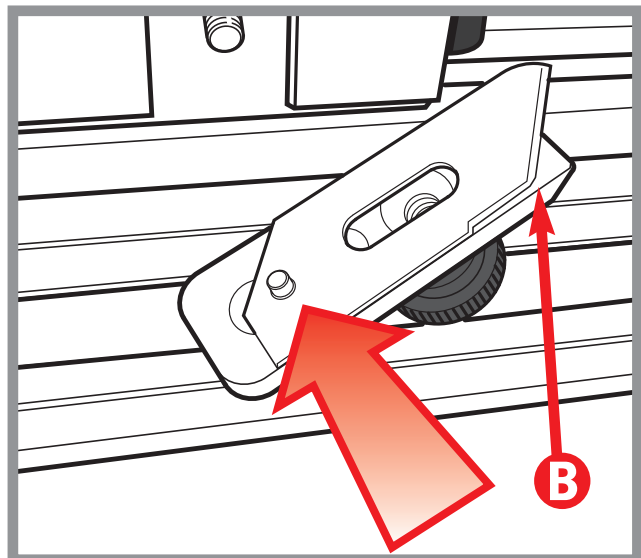

Hold the clamping plate in place on the blade holder and tighten the clamping screw ensuring that the blade is properly located in its groove.

Before tightening the clamping screw the blade depth can be adjusted by sliding the adjustment knob up or down to retract or extend the blade. It is good practice to set the depth so that the minimum amount of blade is exposed to just cut through the material, it takes much less effort and produces a better cut.

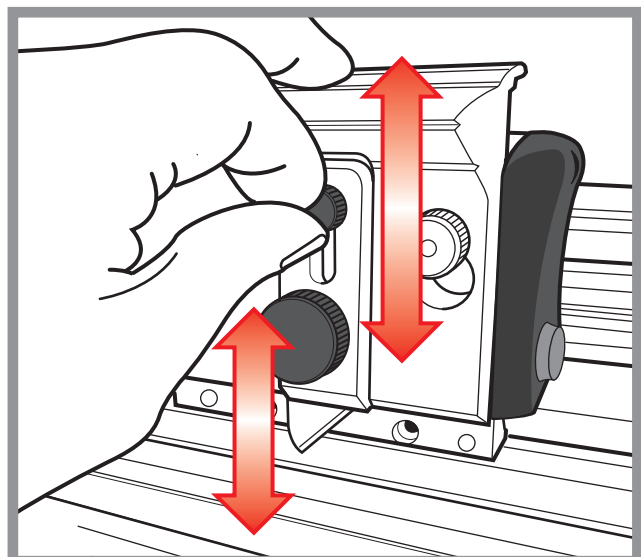

CUTTING

The standard GRAPHIK blade holders can be set to cut at different depths and in either direction by simply adjusting or flipping the blade over in the holder. You can also push or pull the cutting head to suit your own comfort.

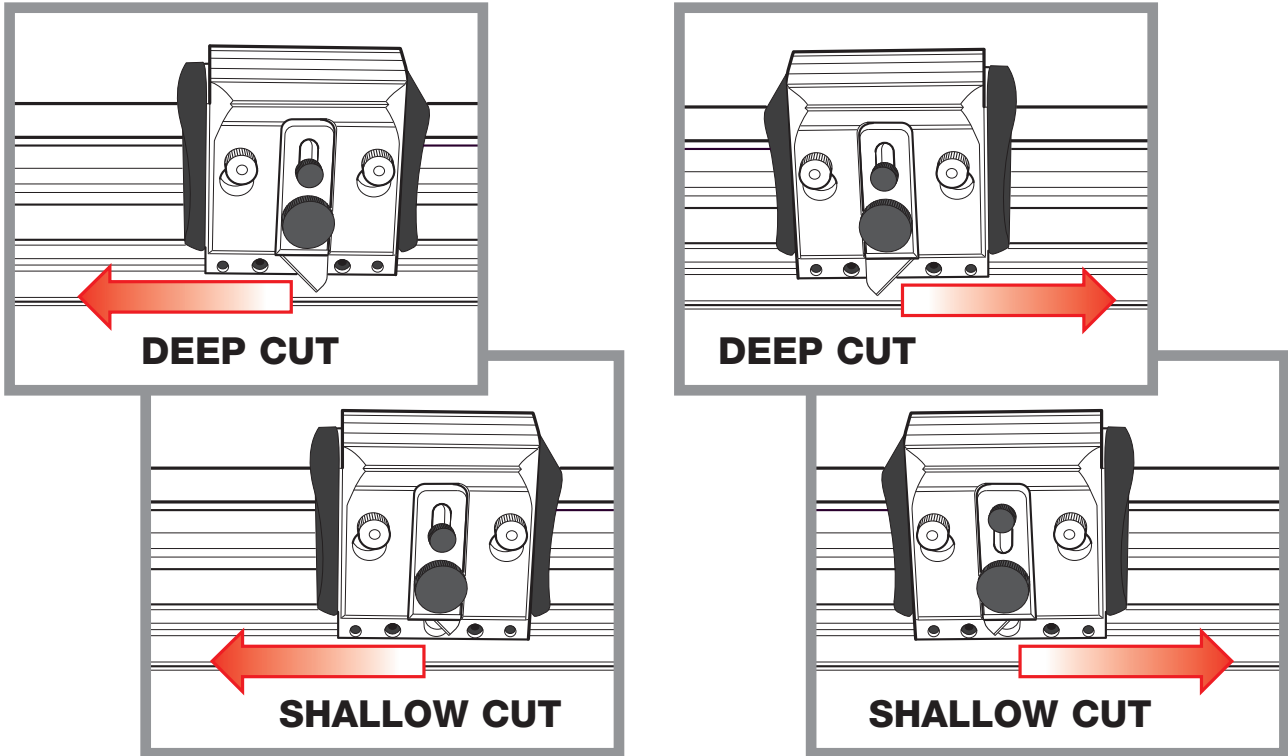

Once the blade is set move the cutting head near to the start of the cut, press down the blade holder and push or pull to make the cut. Only light finger pressure is usually required to depress the blade holder so most of your effort can be directed into pushing the blade through the material.

SCORING HARD PLASTICS

Many hard plastics such as Acrylic can be scored and snapped by hand or over the edge of a bench (use hand and eye protection). The back edge of the GRAPHIK blade can

be used as a scoring blade, position the plastic sheet in the cutter and draw the blade backwards across the surface applying downward pressure to the blade holder, some plastics will benefit from being scored a number of times before snapping.

CUTTING PVC FOAMBOARDS

PVC is a very tough and durable material, to obtain a straight and smooth edge cut the material slowly, if you cut too fast the board will rip and give a jagged uneven edge. Considerably higher cutting performance is obtained from warm room temperature boards, if you store your boards in an unheated room in winter you will find them much

THE ROTARY CUTTER

The Rotary Blade Holder is used to cut textiles, thin papers and other delicate materials, it uses a circular blade to press down onto a cutting mat or sheet of suitable plastic placed on the base of the machine.

The red plastic blade guard helps to protect the blade and fingers but, be very careful as the blade is extremely sharp. The guard has to be closed to allow the blade holder to be fitted or removed, align the scallop **D** in the red plastic guard with the left hand release hole and fit/remove the blade holder in the normal way.

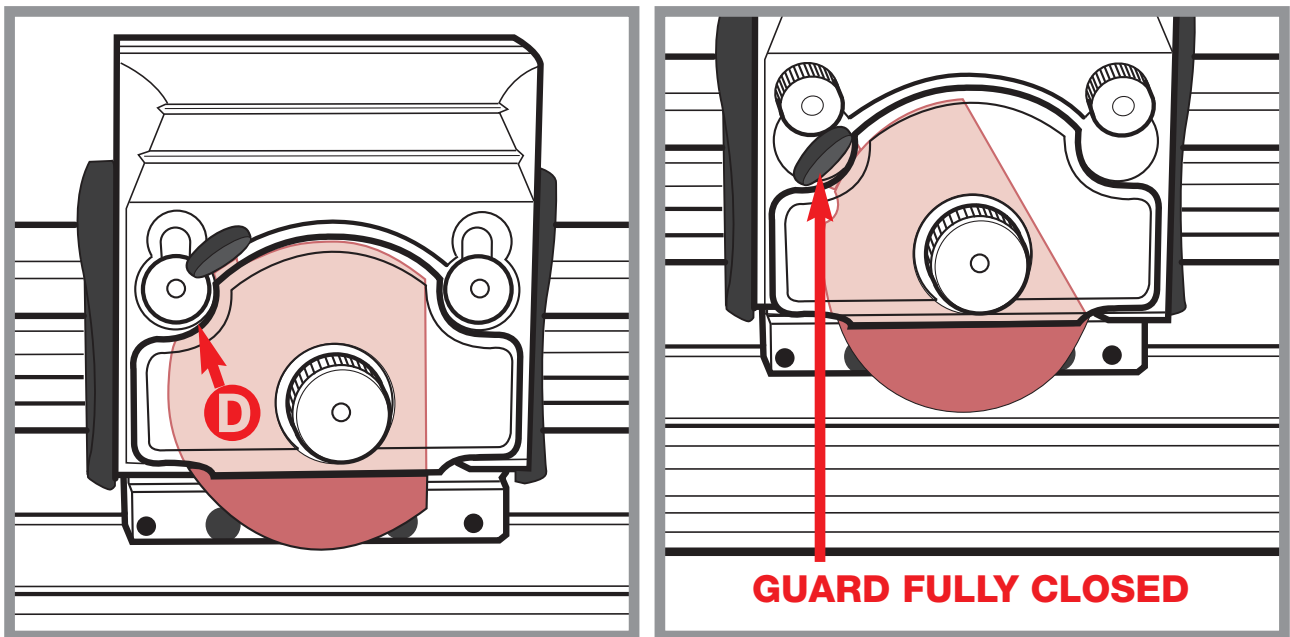

USING THE ROTARY BLADE CUTTER

Position the material to be cut on the cutting mat in the machine and lower the cutter bar. Rotate the safety guard grip clockwise to reveal the blade. Apply downward pressure to the blade holder whilst drawing the cutting blade along the material in one continuous motion.

Some materials will cut better if a harder plastic base is used in place of the cutting mat. Acrylic works well for this, use a piece at least 15cm (6") wide and long enough to support the full cut length of the material. Lighter downward pressure will be required with harder plastic bases.

CHANGING THE ROTARY BLADE

- **The circular blades are extremely sharp - wear protective gloves and handle with care.**

Unscrew the clamping knob **H** to release the clamp plate then carefully remove the blade with the red guard and the blade centre boss.

Separate the blade **E** from the red guard **F** and push out the magnetic centre boss **G**, be extremely careful, the point of a pencil can be used to help push the boss free of the blade. Ensure there is no debris attached to the magnetic boss or any of the other components, reverse the procedure to install the new blade.

Upon first use check the blade is revolving, if it is not it is an indication that the clamping knob **H** is too tight or there is debris inside.

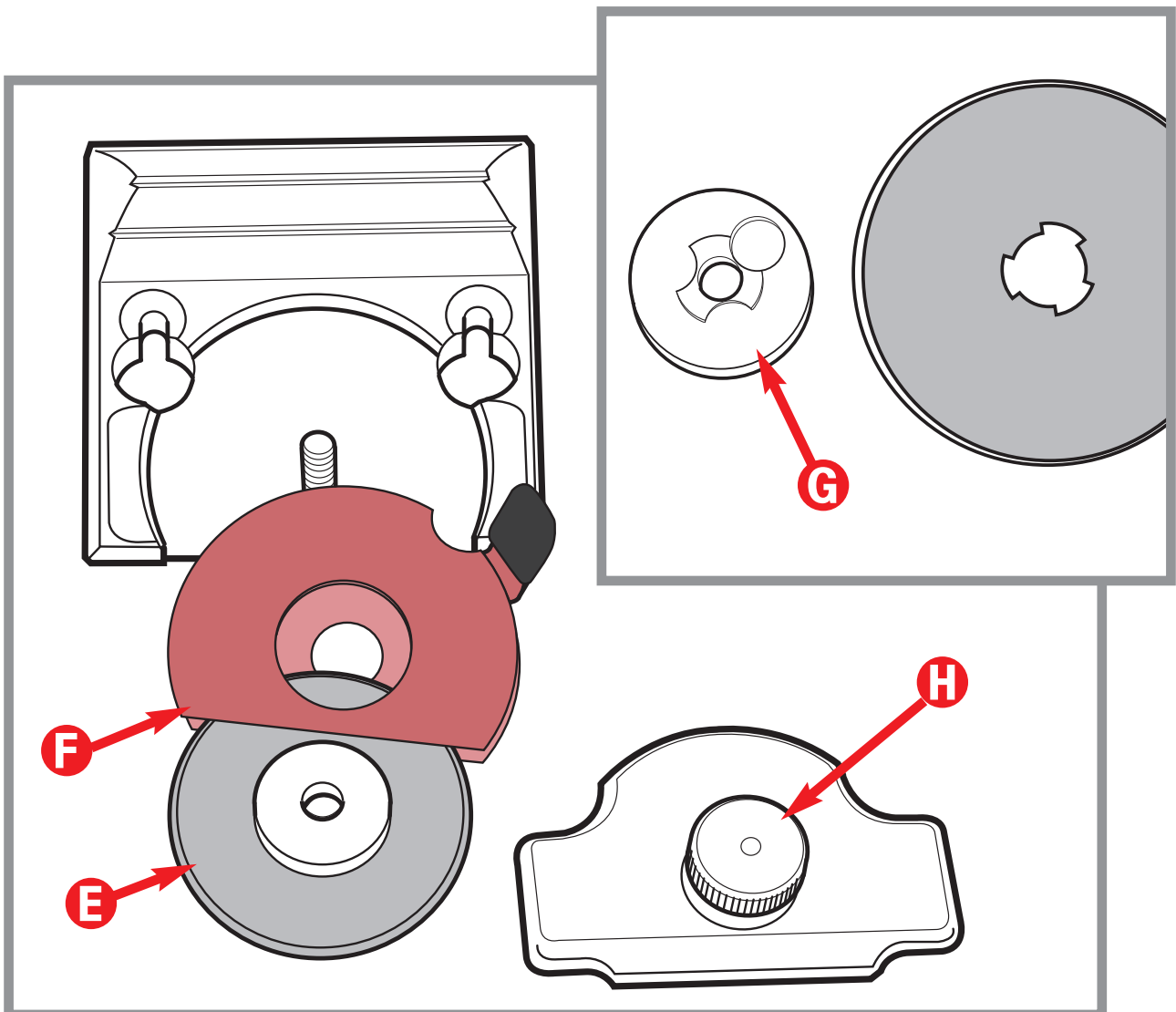

MEDIUM DUTY BLADE HOLDER

Fitting the blade.

Remove the magnetic blade guide by releasing the blade clamping knob **I**.

Place blade onto the guide ensuring the blade notches are properly located and the back face of the blade is lying flat on the guide.

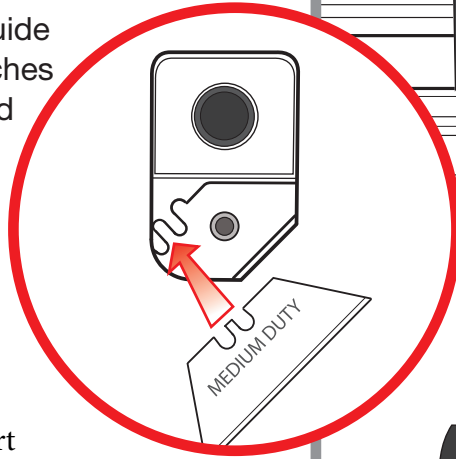

MyBinding.com
5500 NE Moore Court
Hillsboro, OR 97124
Toll Free: 1-800-944-4573
Local: 503-640-5920

Lower the blade guide into position feeding the blade behind the clamping bar.

Adjust the height of the blade guide to give the correct blade depth and tighten the blade clamping screw **I**.

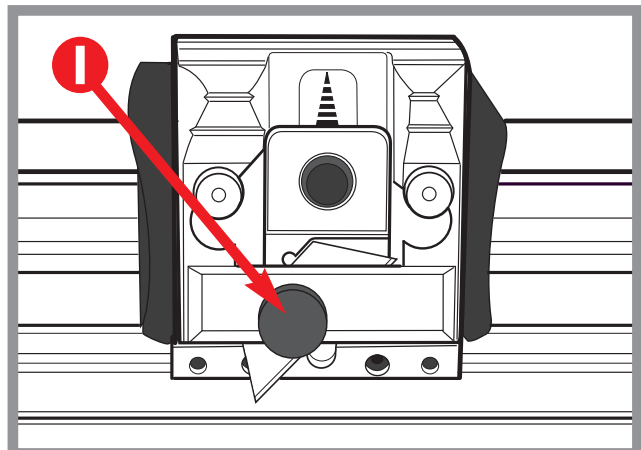
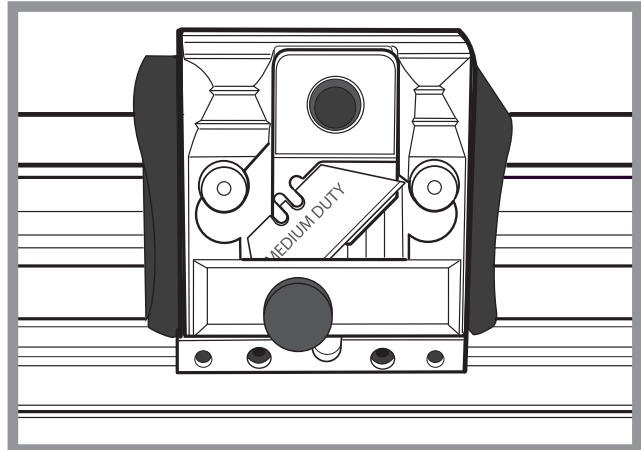
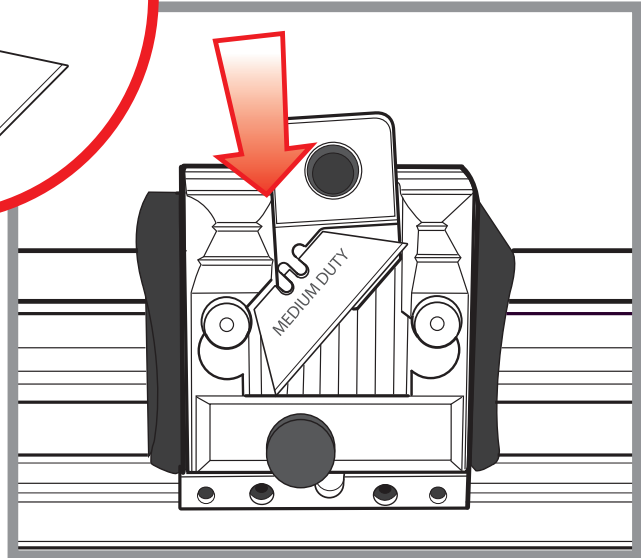
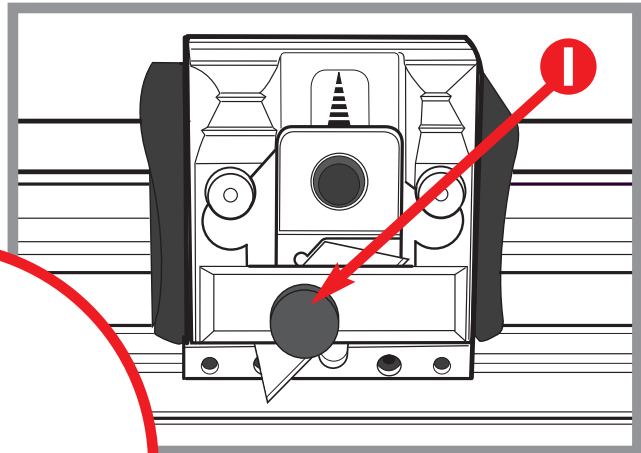

Optimum performance is achieved with a sharp blade set so it is only just deep enough to cut through the material.

For cutting tougher materials such as PVC foamboard and materials up to 13mm (1/2") thick the 'Graphik' blade holder is recommended.

CLEANING AND LUBRICATION

It is good practice to keep a dust sheet over the cutter if it is not to be used for extended periods. In any event regularly clean it with a dry cloth or to remove any stubborn stains use a cloth dampened with a little water/detergent.

Should the cutting head slideway require lubrication use a silicon spray or silicon impregnated sponge.

- **Please note!** Do not use oil or solvents to lubricate or clean the cutter, because the plastic components and bearings will be damaged.

CUTTING HEAD BEARINGS

The bearings that control the sliding motion of the cutting head are manufactured from a high grade polymer and under normal use will last for an extremely long time. As they settle into position you may find a slight amount of side play, this can be removed by tightening the two adjustment screws:

Place the long end of the 2mm Allen key provided into any of the two screws **J** and very gradually tighten it with one hand whilst moving the cutting head up and down the cutter bar with the other. Once you feel the sliding motion start to tighten undo the screw the smallest amount so the cutting head just slides easily.

Repeat this on the other screw, further finer adjustment on each screw may be needed to achieve an easy sliding movement with zero side play.

