

KEENCUT

ADVANCED ROTARY CUTTER & TABLE EDGE ADVANCED ROTARY CUTTER

Ⓜ	INSTRUCTION MANUAL	2
Ⓧ	MANUEL D' INSTRUCTIONS	6
Ⓝ	GEBRAUCHSLANLEITUNG	10
ⓔ	MANUAL DE INSTRUCCION	14
Ⓜ	MANUALE DI ISTRUZIONI	18

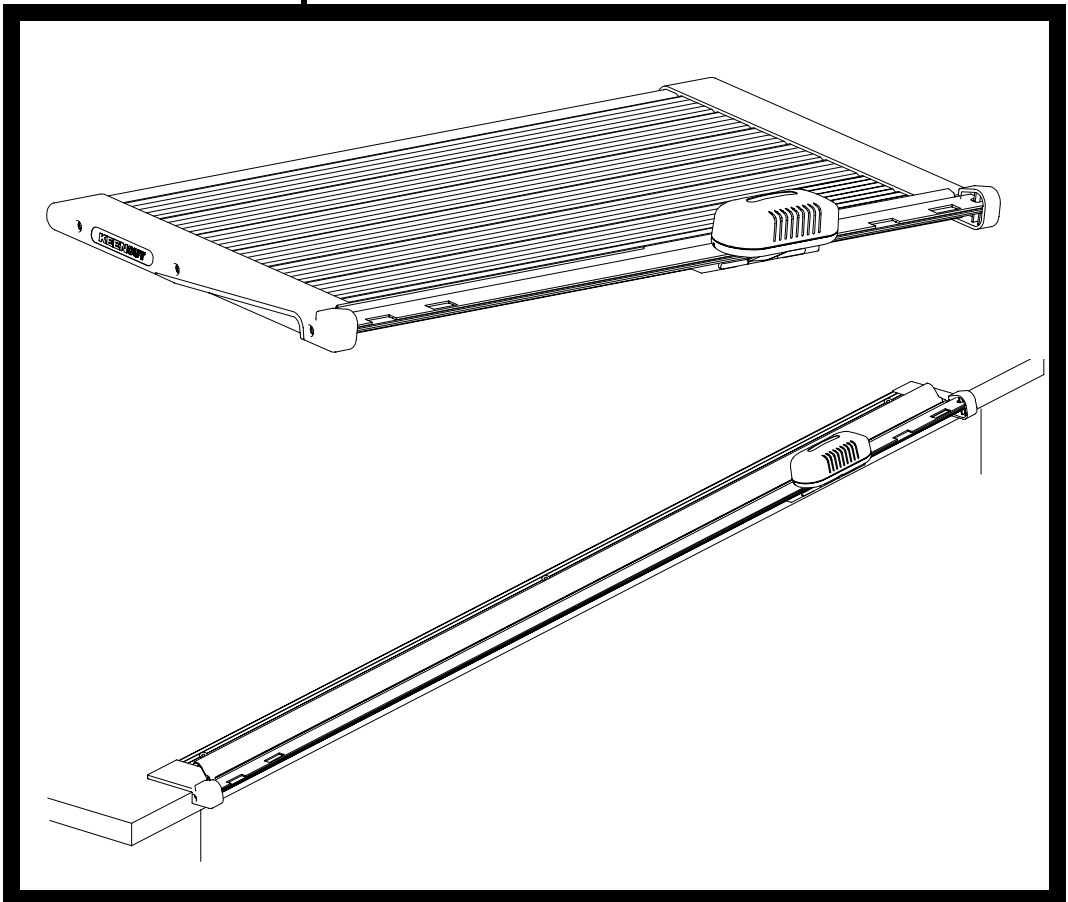

MyBinding.com
5500 NE Moore Court
Hillsboro, OR 97124
Toll Free: 1-800-944-4573
Local: 503-640-5920

KEENCUT

THE WORLD'S FINEST CUTTING MACHINES

Advanced Rotary Cutter User Instructions

Safety & Preparation

Thank you for choosing the Advanced Rotary Cutter made by Keencut. Every effort has been made to bring you a superbly built product with the promise of many years of good service. In order to obtain maximum benefit from your machine please read these instructions carefully. For advice and assistance or replacement parts please contact your distributor or Keencut.

The following instructions will refer to the 'Cutter' which includes both the Advanced Rotary Cutter and the Table Edge Advanced Rotary Cutter unless specified otherwise.

SAFETY

The sliding cutting head contains two very sharp circular blades and the base has a blade fixed to it for the full length of the machine.

- For safety - do not place your fingers near the circular knives or the base blade.
- For safety - move or pick up the Cutter using the moulded finger grips at each end and fit the protective cover to the fixed blade.
- Do not use the Cutter if the Cover for the sliding Cutter Head has been removed or broken.

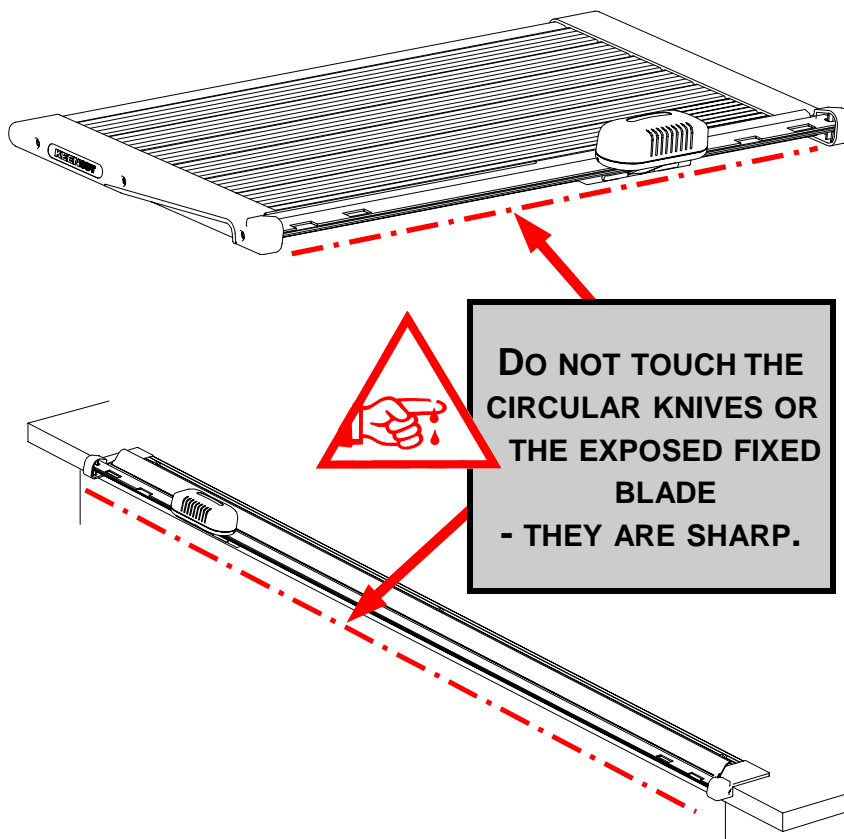

IT IS ESSENTIAL THAT THE TABLE OR WORK BENCH SURFACE ON WHICH THE CUTTER IS INSTALLED IS **FLAT**. IF THE SURFACE IS BOWED IT CAN AFFECT THE STRAIGHTNESS OF THE BLUE PLASTIC CLAMP STRIP. ENSURE BEFORE USE THE CLAMP STRIP IS CLEAR OF THE CUTTING LINE.

The Cutters have been designed to cut a large range of materials up to a thickness of 2mm (0.080"). The unique concept of running the cutting head on a sliding bearing system below the surface of the base enables this thickness of cut to be maintained irrespective of the length of the machine.

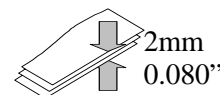

PREPARING THE CUTTER

Pairs of both Metric and Imperial self-adhesive scales are supplied to fit at each end of the Advanced Rotary Cutter. Select which measuring system you require and discard the others. To avoid errors place the left hand scale to the left of the machine and the right hand scale to the right. The selected scale should be aligned, using the 7½" mark of the Imperial scale or the 19cm mark of the Metric scale, with the groove on the base plate indicated by the red arrow sticker. Taking care to maintain the alignment remove the backing paper progressively while fixing each scale in the normal way. The red arrow sticker can then be removed.

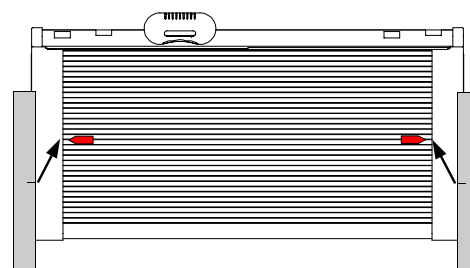

Remove the red protective cover from the fixed blade before use.

MyBinding.com
5500 NE Moore Court
Hillsboro, OR 97124
Toll Free: 1-800-944-4573
Local: 503-640-5920

Advanced Rotary Cutter User Instructions

Preparation & Use

THE ALUMINIUM SQUARING ARM (Advanced Rotary Cutter only, 76cm (30") and above)

Those machines with cut lengths 76cm (30") and above are fitted with an additional aluminium squaring arm and sliding measuring stop.

To fix the scales, firstly remove the measuring stop. Pass a rule under the clamping strip and measure from the cutting edge 250mm for the metric scale or 10" for the Imperial scale and make a small pencil mark on the squaring arm. Affix the self-adhesive scale to align the 250mm or 10" graduation with the pencil mark. The plain sticker fits inside the groove of the squaring arm and covers the two fixing screws. With a sharp blade trim the excess from the end of the scale.

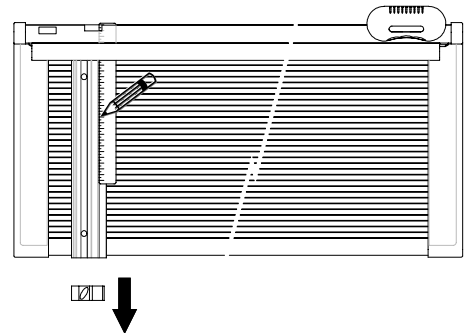

An extended Squaring Arm is available as an optional extra.

FIXING THE TABLE EDGE ADVANCED ROTARY CUTTER TO THE TABLE



ENSURE THE RED EDGE PROTECTOR REMAINS IN POSITION ON THE FIXED BLADE THROUGHOUT THE FITTING PROCEDURE.

Place the Cutter on the edge of the table, mark with a pencil the positions of the fixing holes, remove the Cutter to a safe position. Make a starting hole for each of the screws using a small drill or a pointed tool. It is essential that the starting holes are accurately positioned to prevent any distortion of the Cutter when fixing it in place.

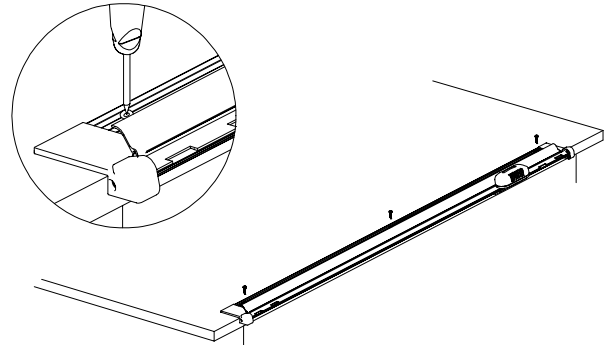

Position the Cutter back onto the table edge and fix it down using the countersink screws supplied.

Fix a piece of 3mm MDF, PVC foamboard, or similar material to the table top as shown to bring the table surface in line with the base plate level of the Cutter.

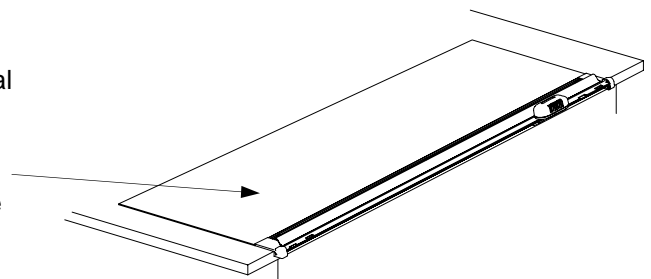

Remove the red plastic protective cover from the fixed blade before use.

OPERATION

Park the sliding cutting head at either end of the machine which will release the clear plastic clamp strip. Slide the material to be cut under the clamp strip and align it as required. Slide the cutting head which will automatically clamp the work while cutting through it.

Using your free hand to apply downward pressure on heavy board or multiple sheets will help to prevent any movement during cutting and ensure a very straight cut.

Advanced Rotary Cutter User Instructions

Maintenance

MAINTENANCE

The Cutters are designed to be maintenance free but occasional cleaning and lubrication of the sliding bearing track will ensure your cutter stays in peak operating condition:-

- Cleaning – **Warning :- Please do not use solvent cleaners or mineral oil anywhere near any plastics which includes the slide bearings and track.** Slightly dampen a cloth with water and wipe away any accumulated dirt. A little detergent may be necessary to remove stubborn greasy marks.
- Lubrication - **Warning :- Please do not use oil, it can destroy plastics,** use a silicone lubricant or silicone release fluid preferably aerosol and lightly apply to the sliding track. Wipe away all wetness with a dry cloth to avoid attracting and retaining dust. The silicone impregnates the hard anodised surface of the track and will lubricate for a long time without renewal.

Do not touch the edges of the circular knives or the fixed blade, they are sharp.

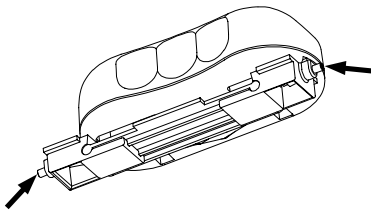

The bearing blocks are adjustable. If the cutting head feels loose on the track adjust the screw in each bearing block (as shown) with the hexagon key provided. Turning the key clockwise will remove excess movement. A little movement is acceptable to ensure free running of the sliding block.

Cleaning Inside the sliding cutter head.

Paper, card and self-adhesive materials produce dust and debris. In extreme circumstances it may be necessary to clean the inside of the sliding cutter head in order to restore free running of the circular knives. To remove the Cutter Head Cover release the two 'snap on' fixings by pressing a small screwdriver into the slot (A) while gently lifting the end of the cover as it is released. Repeat for the other end (B) as shown. The Cover can then be lifted off and the Cutter Head cleaned.

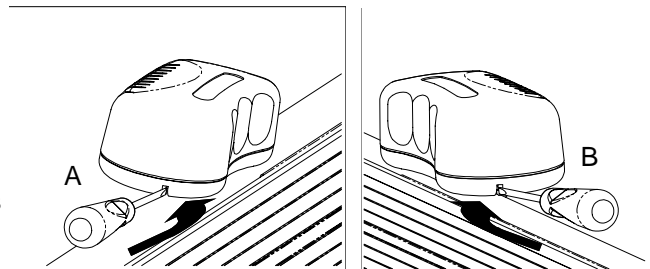

DO NOT TOUCH THE EDGES OF THE CIRCULAR KNIVES, THEY ARE EXTREMELY SHARP.

To replace the Cover, align with the Cutter Base and push down, the two 'Snap on' fixings should snap into place, check the Cover is firmly fixed in position.



DO NOT ATTEMPT TO USE THE CUTTER IF THE SLIDING HEAD COVER IS REMOVED OR INCORRECTLY FITTED, SERIOUS INJURY COULD RESULT.

MyBinding.com
5500 NE Moore Court
Hillsboro, OR 97124
Toll Free: 1-800-944-4573
Local: 503-640-5920

Advanced Rotary Cutter User Instructions

Spare Parts

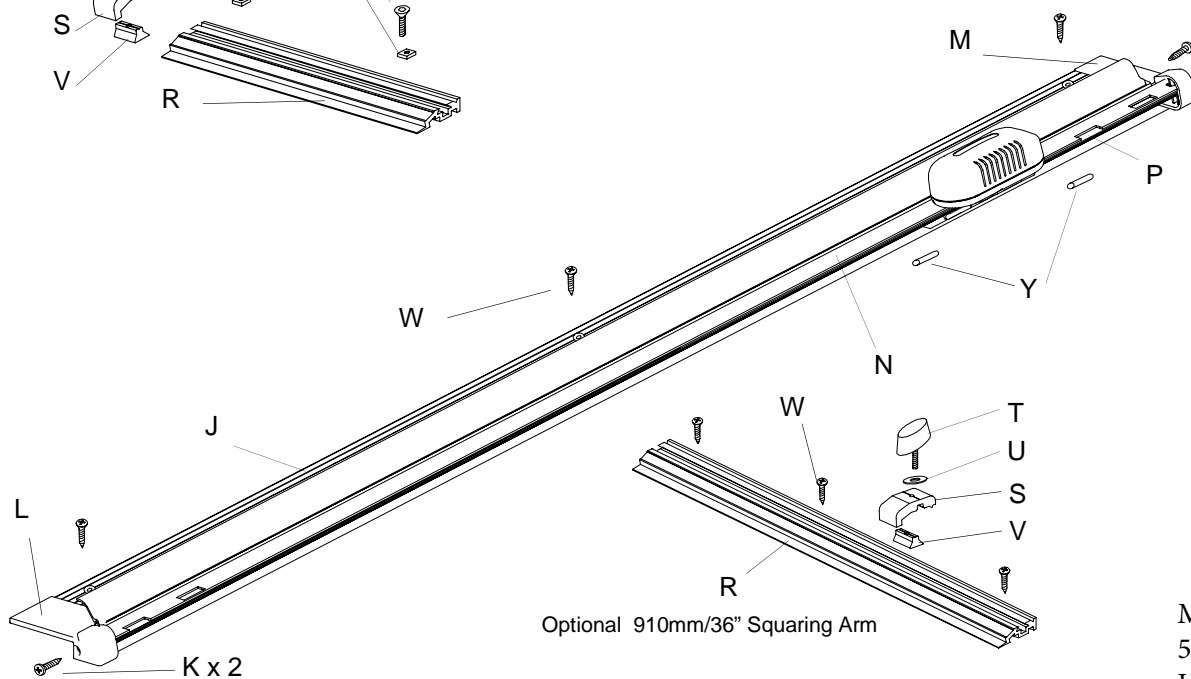
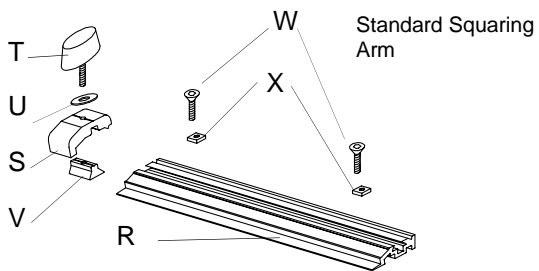
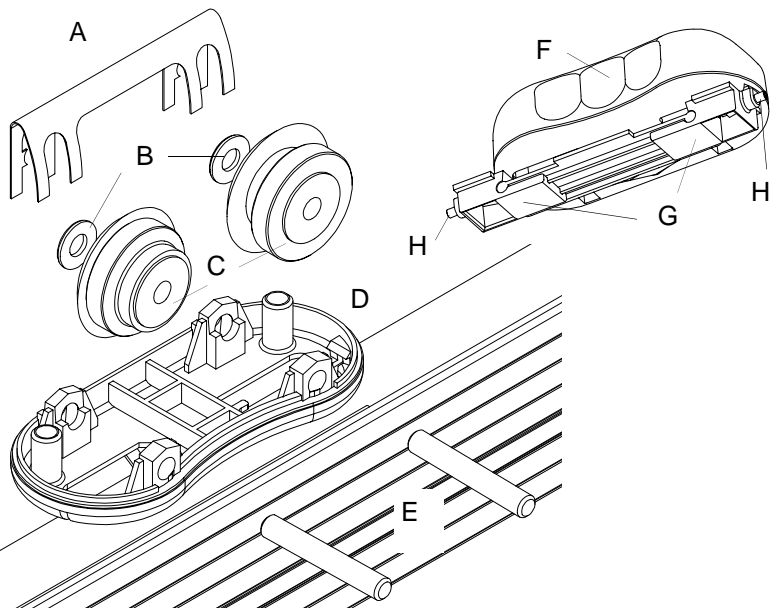
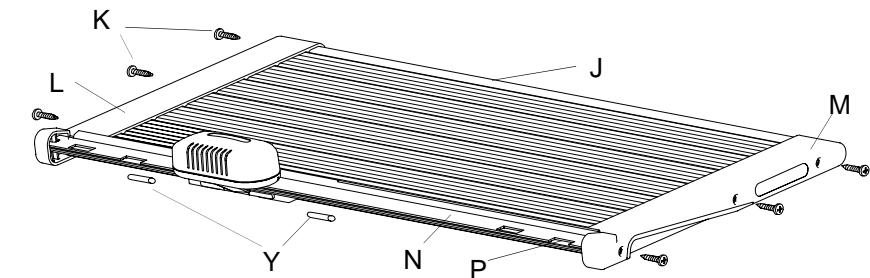

Key	Advanced Rotary Cutter		Table Edge Advanced Rotary Cutter	
	Qty.	Code	Qty.	Code
A	1	CA25/195	1	CA25/195
B	2	CA30/083	2	CA30/083
C	1 pr.	KX96/000	1 pr.	KX96/000
D	1	CA10/273	1	CA10/273
E	2	KT01/103	2	KT01/103
F	1	CA75/119	1	CA75/119
G	2	CA75/120	2	CA75/120
H	2	CA30/273	2	CA30/273
J	1	KT0*/100	1	KT5*/113
K	6	CA30/249	2	CA30/249
L	1	CA75/116	1	KT51/111
M	1	CA75/117	1	KT51/112
N	1	KT0*/101A	1	KT0*/101A
P	1	KT0*/102	1	KT0*/102
R	1	KT05/107	1	KX94/100
S	1	KT05/108	1	KT05/108
T	1	CA30/007	1	CA30/007
U	1	CA30/033	1	CA30/033
V	1	KL01/166	1	KL01/166
W	2	CA30/117	*	CA30/242
X	2	CA30/275	-	-
Y	2	KT01/106	2	KT01/106
Rubber Feet	*	CA75/122	-	-
Scales Sticker	1	CA25/198	-	-
Sq. Arm Scale Stickers	1	CA25/211	1	CA25/211

* State size of machine when ordering parts

Optional 910mm/36" Squaring Arm

MyBinding.com
 5500 NE Moore Court
 Hillsboro, OR 97124
 Toll Free: 1-800-944-4573
 Local: 503-640-5920

KEENCUT

THE WORLD'S FINEST CUTTING MACHINES

MyBinding.com
5500 NE Moore Court
Hillsboro, OR 97124
Toll Free: 1-800-944-4573
Local: 503-640-5920