

***Ghent 36.5" x 48.5" Magnetic  
Porcelain Whiteboard with  
Wood Frame***

Product Spec Sheet



*Provided by*

**MyBinding.com**

*When Image Matters.*

Call Us at 1-800-944-4573



# M1W Series

WOOD FRAMED PORCELAIN WHITEBOARD

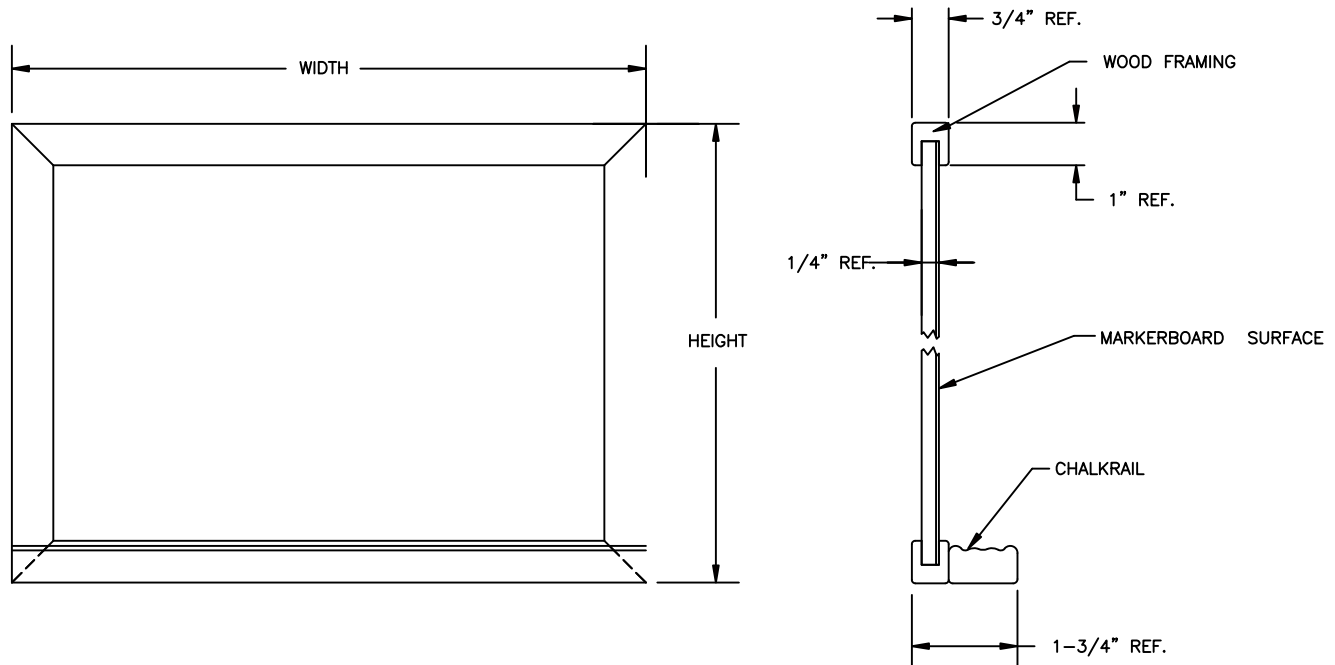

MyBinding.com  
5500 NE Moore Court  
Hillsboro, OR 97124  
Toll Free: 1-800-944-4573  
Local: 503-640-5920

## Specifications

Wood framing to be clear-coated oak.  
Framing to be permanently attached to the porcelain writing panel.  
Writing panel shall be 28ga porcelain-on-steel laminated to 1/4" hardboard with a mylar backing.  
Carries a 50-year guarantee.  
Available in sizes 3'Hx4'W, 4'Hx4'W, 4'Hx5'W, 4'Hx6'W, 4'Hx'8'W, 4'Hx10'W, and 4'Hx12'W.