

MyBinding.com  
5500 NE Moore Court  
Hillsboro, OR 97124  
Toll Free: 1-800-944-4573  
Local: 503-640-5920



# Owner's Manual

**Paramount 65X**

## **GRAPHIC LAMINATION PRODUCTS**



*Please read and retain these instructions.*

*To register your product, please go to [www.royalsovereign.com](http://www.royalsovereign.com)*

**Royal Sovereign International Inc.**

# CONTENTS

---

<b>1. Introduction</b> .....	<b>3</b>
<b>2. Safety Precautions</b> .....	<b>4</b>
<b>4. Installation</b> .....	<b>5</b>
<b>5. Product Identification</b> .....	<b>7</b>
<b>6. Control Panel</b> .....	<b>8</b>
<b>7. Using Foot Pedal</b> .....	<b>9</b>
<b>8. Loading Film</b> .....	<b>9</b>
<b>9. Threading Film</b> .....	<b>9</b>
9.1 Decaling .....	10
9.2 Mounting .....	10
<b>10. Maintenance</b> .....	<b>10</b>
<b>11. Troubleshooting</b> .....	<b>11</b>
<b>12. Specifications</b> .....	<b>12</b>
<b>13. Warranty</b> .....	<b>13</b>

MyBinding.com  
5500 NE Moore Court  
Hillsboro, OR 97124  
Toll Free: 1-800-944-4573  
Local: 503-640-5920

# Graphic Lamination Products

Model Paramount 65X

## 1. INTRODUCTION

Thank you for choosing a Royal Sovereign laminator. It has been designed and manufactured to provide years of continuous service.

For complete operating and maintenance information please read this manual thoroughly. Upon receipt of your laminator, please inspect the box, the machine and all other contents for shipping damage.

Damage should be brought to the immediate attention of the delivering carrier

**MyBinding.com**  
5500 NE Moore Court  
Hillsboro, OR 97124  
Toll Free: 1-800-944-4573  
Local: 503-640-5920

## 2. SAFETY PRECAUTIONS

Failure to comply with any of the following safety procedures could result in serious injury. Please read the instructions carefully and keep for future reference.

1. Only a licensed electrician should install wiring and outlet for the laminator.
2. Ensure the unit is plugged into a properly grounded outlet with the correct voltage.
3. Make sure the pressure value is less than 0.6 MPa (87PSI) which can be adjusted it by the regulating valve which is located in the body on the right hand side then connect the air pipe to the air intake.
4. Keep hands and clothing (i.e. Neckties) away from rollers. The rollers have pinch points that can trap body parts or clothing and cause serious injury.
5. Keep flammable and wet objects away from the machine.
6. Place machine on a level surface, then set the moveable feet down to floor to keep the machine steady.
7. Avoid excessive sunlight, humidity and extreme temperatures.
8. Ensure the unit is turned off, cooled, and unplugged from the outlet prior to moving and/or repairing.
9. Keep out of reach of children.
10. Only Royal Sovereign authorized maintenance and service technicians should make repairs.
11. Do not attempt to laminate items that exceed total recommended material thickness for the unit
12. When cleaning the machine, don't use flammable sprays or materials.
13. Do not touch the rollers when they are hot or place foreign objects inside the machine.
14. Do not cover the surface of the machine until the machine has completely cooled.
15. In the event of an emergency, press emergency switch immediately.
16. Temperature of circumstance:  $20^{\circ}\text{C} \pm 5^{\circ}\text{C}$ ; humidity of circumstance  $< 95\%$  ( $20^{\circ}\text{C} \pm 5^{\circ}\text{C}$ )
17.  Warning - Hazardous Moving Parts – Keep Fingers And Other Body Parts Away.

## 3. INSTALLATION

**Note: The laminator should be installed by a trained service technician.**

The laminator comes fully assembled, except for the feed table and paper guide to avoid shipping damage. Upon arrival, thoroughly inspect the unit. It is imperative that any shipping damage is reported and a claim is filed with the delivering carrier immediately upon receipt.

The laminator should be located in an area with adequate work space for feeding graphics and lamination materials.

Avoid placing the laminator in a dusty area or near sources of extreme heat or cold.

Once the laminator is in place, lock the casters into position. Always unlock the casters when moving to a different location.

### ELECTRICAL REQUIREMENTS

Royal Sovereign recommends that a licensed electrician ensures proper power installation to your laminator in accordance with electrical codes in your area.

The laminator should have a dedicated power line.



120V UL



230V UL

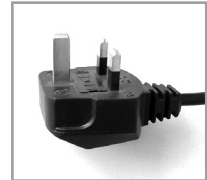

240V UK



220V EU







220V AU

MyBinding.com  
5500 NE Moore Court  
Hillsboro, OR 97124  
Toll Free: 1-800-944-4573  
Local: 503-640-5920

## 4. INCLUDED WITH LAMINATOR

Thoroughly inspect the parts and the unit. It is imperative that any missing parts are reported and a claim is filed with the reseller immediately upon receipt of shipment.

Part Name	Quantity	Picture
Laminator	1	
Owner's Manual	1	
Spare Motor Fuse - FUSE(50T) (6.3A)	1	
Spare Main Power Fuse - FUSE(65TS) 10A/20A	1	
Key	2	

MyBinding.com  
 5500 NE Moore Court  
 Hillsboro, OR 97124  
 Toll Free: 1-800-944-4573  
 Local: 503-640-5920

# Paramount 65X

MyBinding.com  
5500 NE Moore Court  
Hillsboro, OR 97124  
Toll Free: 1-800-944-4573  
Local: 503-640-5920

## 5. PRODUCT IDENTIFICATION

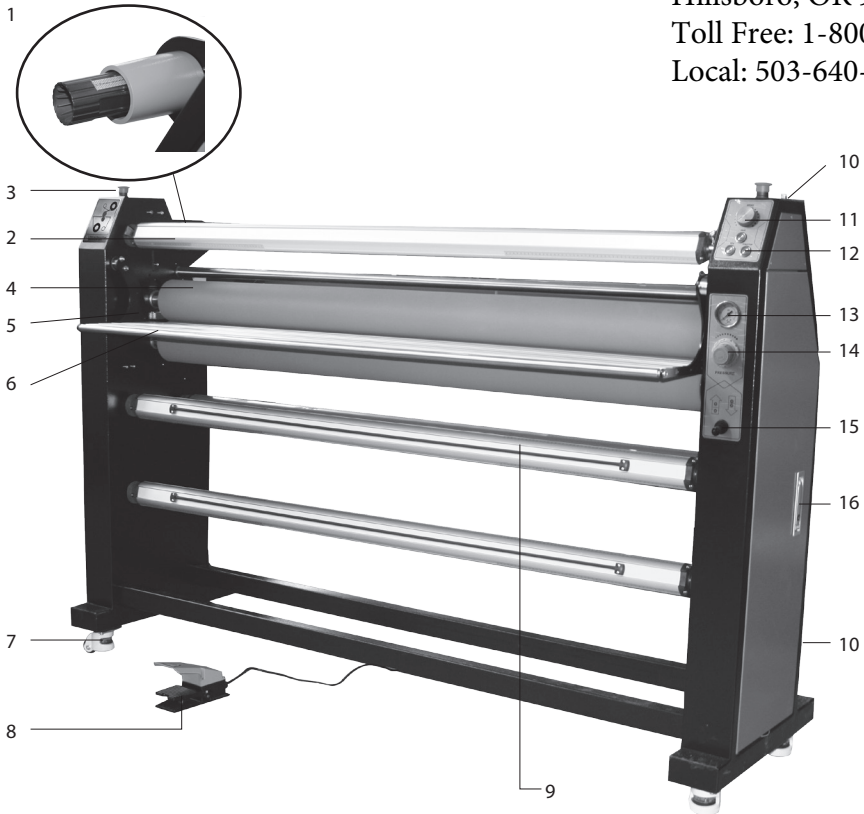

1	Film Tension Knob	9	Shaft Feeder
2	Shaft Release Liner	10	Air Intake
3	Emergency Switch	11	Knob Speed Control
4	Roller	12	Button
5	Safety Sensor	13	Pressure Gauge
6	Table Front	14	Pressure Regulating Valve
7	Foot	15	Pneumatic Toggle
8	Foot Switch	16	Door Lock

## 6. CONTROL PANEL

	<p>Heat</p>	<p>To change the mode from cold to heat assist. Temperature for heat assist on upper roller is max 122°F/50°C.</p>
	<p>Reverse</p>	<p>To reverse the rollers, press and hold the button.</p>
	<p>Speed</p>	<p>Rotate the knob to control the roller's speed from 0 to 19.7 ft/min.</p>
	<p>Run/Stop</p>	<p>To start or stop the rollers.</p>

	<p>Pressure gage: To indicate the pressure of top roller from 0 to 1Mpa (145Psi) pressure value</p>
	<p>Pressure regulating valve: To change the pressure of top roller from 0 to 0.6Mpa (87Psi) pressure value</p>
	<p>Pneumatic Toggle: To make the top roller go up and down</p>



## 7. USING FOOT PEDAL

Place the foot pedal on the floor in front of the machine. Once all correct settings are displayed, you may use the foot pedal to operate the laminator for "Hands Free Operation." To activate the machine, press the foot pedal once and then release. Repeat to stop the rollers.



## 8. LOADING FILM

**Royal Sovereign films are wound with the adhesive side facing the inside of the roll (adhesive in).**

Loading films to upper and lower film shafts:

Remove the upper and lower film shafts from the machine and load the films (Center the upper and lower films on the shaft). Note the direction of the adhesives on the lower and upper films

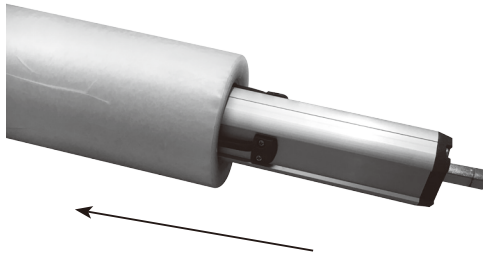

## 9. THREADING FILM



MyBinding.com  
5500 NE Moore Court  
Hillsboro, OR 97124  
Toll Free: 1-800-944-4573  
Local: 503-640-5920

## 9.1. Decaling

1. Turn the power switch on ("I" position). The Power switch is located on the rear left side of the unit.
2. Complete the steps as in the "LOADING FILM" section
3. Pull the top film down to the bottom of the craft paper/mounting film.
4. Align and center the craft paper/mounting film to the top film
5. Peel the top film off

## 9.2. Mounting

Please adjust the wheel to change the roller pressure with different material for the best laminating quality.

1. Lay the decaled image face down on a flat surface. Carefully peel back and put a crease along the edge of the release liner
2. With the image facing up, align the image onto the board. Press firmly from the center out.
3. Adjust the pressure lever to ensure the proper opening.
4. Flip the image over the upper roller and hold on to the release liner.
5. Press the foot pedal once, and then let it go while slowly pulling the release liner as the board enters the main roller nip.

Press the foot pedal once again when the board has completely exited from the rear of the unit.  
Trim the board if necessary.

# 10. MAINTENANCE

## Cleaning the Body of the laminator

1. To clean the machine body, dampen a cloth with water only and gently wipe the machine clean.

## Removing Adhesive Build Up

1. Remove the film from the laminator.
2. Use a damp (water only) cloth and a rubber gum eraser to remove the adhesive on the Teflon (metal) and silicone rollers.

Note Rub firmly but do not scrub the rollers vigorously as this may scratch the surface.  
Do not use sharp metal objects, steel wool, or abrasives, as these may also damage the rollers.

## Lubrication

1. Drive chain and sprockets should be lubricated with either a light coat of gear lube or heavy grease (lithium grease) after 6 months or 1000 hours of operation, whichever comes first.

## 11. TROUBLESHOOTING

Symptom	Cause	Possible Solution
Machine will not turn on:	<ul style="list-style-type: none"> <li>a. Power plug is not plugged in.</li> <li>b. Power switch is in "0" (Off) position.</li> <li>c. Tripped circuit breaker.</li> <li>d. Blown main power fuse.</li> </ul>	<ul style="list-style-type: none"> <li>a. Plug the power cord into appropriate outlet.</li> <li>b. Put the power switch to the "1" (On) position.</li> <li>c. Reset the circuit breaker.</li> <li>d. Replace the fuse.</li> </ul>
There is power, but the roller are not turning after the "RUN" button is pressed:	<ul style="list-style-type: none"> <li>a. Emergency switch(es) is (are) engaged.</li> <li>b. Laser safety sight is tripped</li> <li>c. Blown motor fuse.</li> </ul>	<ul style="list-style-type: none"> <li>a. Disengage the emergency switch(es).</li> <li>b. Remove obstacles or reposition media</li> <li>b. Replace the motor fuse.</li> </ul>
The unit is not heating up:	<ul style="list-style-type: none"> <li>a. Did not raise the temperature.</li> </ul>	<ul style="list-style-type: none"> <li>a. Raise the temperature.</li> </ul>
Curled lamination:	<ul style="list-style-type: none"> <li>a. Upward curl.</li> <li>b. Downward curl.</li> </ul>	<ul style="list-style-type: none"> <li>a. Loosen the top roll film tension.</li> <li>b. Loosen the bottom roll film tension</li> </ul>

MyBinding.com  
 5500 NE Moore Court  
 Hillsboro, OR 97124  
 Toll Free: 1-800-944-4573  
 Local: 503-640-5920

## 12. SPECIFICATIONS

Description	Paramount 65X
Power Supply	AC100V,120V,220~240V,50/60Hz
Power Consumption	1450W
Maximum Laminating Width	65"(1650mm)
Max. Material Diameter(Film)	Ø 7.8" (200mm)
Maximum Laminating Speed	19.7 ft./min. (6m/min)
Ready Time	<40min
Heating Method	Hot Roller
Maximum Temperature	122°F(50°C)
Film Core	3" Auto Grip
Roller Nip	1.8" (30mm)
Reverse	Yes
Take-Up System(Upper)	Yes
Rewinder(Front & Rear)	Yes
Front Feeder	Yes
Unit Dimension (w x d x h)	83" x 30" x 50" (2100x750x1250 mm)
Unit Weight	550 lbs. (280kg)

## 13. WARRANTY

Royal Sovereign International warrants the equipment sold is free from defects in material and workmanship for a period of One (1) year for Parts and Labor from the date of installation, excluding lamination rollers which are warranted for Six (6) months. This warranty is extended only to the original purchaser. This warranty is the only warranty made by Royal Sovereign International and cannot be modified or amended. Royal Sovereign's sole and exclusive liability and the customer's sole and exclusive remedy under this warranty shall be, at Royal Sovereign's option, to repair or replace any such defective part or product. These remedies are only available if Royal Sovereign's examination of the product discloses to Royal Sovereign's satisfaction that such defects actually exist and were not caused by misuse, neglect, attempt to repair, unauthorized alternation or modification, incorrect line voltage, fire, accident, flood or other hazard.

All warranty claims must be filed through the authorized Royal Sovereign dealer or reseller through which the equipment was originally purchased. Model, serial number and date of delivery are required for all claims.

The warranty made herein is in lieu of all other warranties, expressed or implied, including any warranty or merchantability or fitness for a particular purpose. Royal Sovereign will not be liable for personal damage or personal injury (unless primarily caused by its negligence), loss of profit, or other incidental or consequential damages arising out of the use or inability to use this equipment.

### LIMITED WARRANTY

This warranty specifically does not cover damage to laminating rollers caused by knives, razor blades, or any sharp objects or abrasives, or failure caused by adhesives, or damage caused by lifting, tilting or improper use of the machine. Warranty repair or replacement by Royal Sovereign or its authorized Reseller(s) does not extend the warranty beyond the initial one year period from the date of installation. Unauthorized customer alterations will void this warranty.

MyBinding.com  
5500 NE Moore Court  
Hillsboro, OR 97124  
Toll Free: 1-800-944-4573  
Local: 503-640-5920