



OWNER'S MANUAL

RSL-2701



Read all instructions carefully before use.

For any Customer Support needs please choose the
Customer Support tab on www.royalsovereign.com

MyBinding.com
5500 NE Moore Court
Hillsboro, OR 97124
Toll Free: 1-800-944-4573
Local: 503-640-5920



TABLE OF CONTENTS

TOPIC	PAGE
1. Introduction	3
2. Package Contents.....	3
3. Safety Precautions.....	4
4. Parts	5
5. Control Panel	6
6. Features Guide.....	7
7. Film Loading and Threading	8
8. Operation Instructions.....	11
9. Maintenance	11
10. Trouble Shooting Guide.....	12
11. Specification	13
12. Warranty	14

MyBinding.com
5500 NE Moore Court
Hillsboro, OR 97124
Toll Free: 1-800-944-4573
Local: 503-640-5920

TABLE TOP LAMINATOR

1. INTRODUCTION

Thank you for purchasing the Table Top Laminator. It has been designed and manufactured to provide years of continuous service. For high quality lamination, please read this instruction manual thoroughly. This manual will provide you with complete operating and maintenance information.

2. PACKAGE CONTENTS

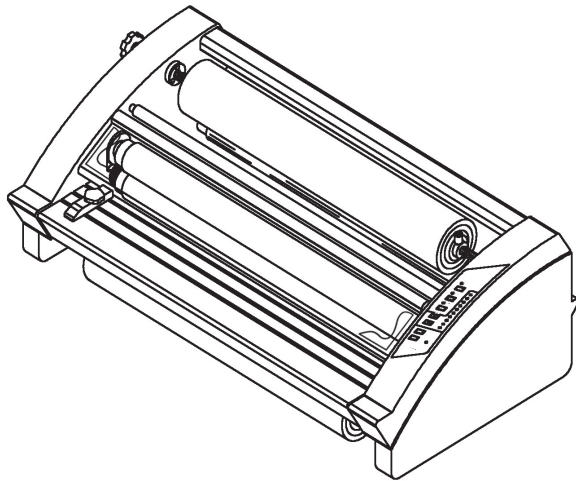

Film leader board



Manual

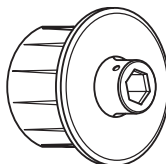

Core 4EA



Fuse

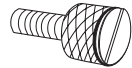

Core bolt 4EA

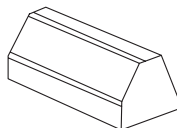

Dust cover

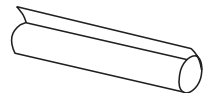

Sample roll film 2EA

3. SAFETY PRECAUTIONS

Failure to comply with any of the following safety procedures could result in serious injury. Please read the instructions carefully and keep for future reference.

1. Only a licensed electrician should install wiring and outlet for the laminator.
2. Ensure the unit is plugged into a properly grounded outlet with the correct voltage.
3. Keep hands and clothing (i.e. Neckties) away from rollers. The rollers have pinch points that can trap body parts or clothing and cause serious injury.
4. Keep flammable and wet objects away from the machine.
5. Place machine on a level surface.
6. Avoid excessive sunlight, humidity and extreme temperatures.
7. Ensure the unit is turned off, cooled, and unplugged from the outlet prior to moving and/or repairing.
8. Keep out of reach of children.
9. Only authorized maintenance and service technicians should make repairs.
10. Do not attempt to laminate items that exceed total recommended material thickness for the unit
11. When cleaning the machine, don't use flammable sprays or materials.
12. Do not touch the rollers when hot.
Do not place any foreign objects inside the laminator.
13. Do not cover the surface of the machine until the machine has completely cooled.

MyBinding.com
5500 NE Moore Court
Hillsboro, OR 97124
Toll Free: 1-800-944-4573
Local: 503-640-5920

TABLE TOP LAMINATOR

4. PARTS

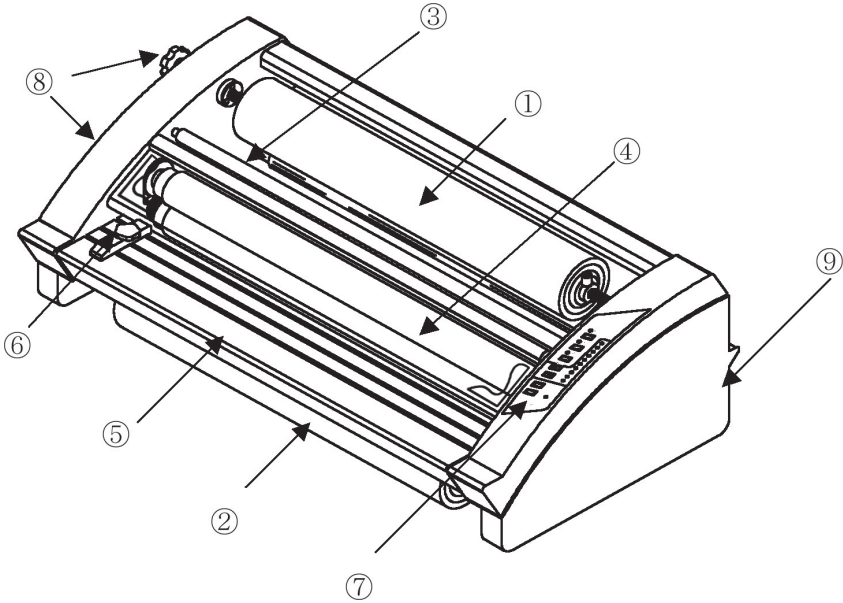

- | | | |
|------------------|-----------------|-----------------|
| 1. Upper Film | 2. Lower Film | 3. Idle Bar |
| 4. Hot Rollers | 5. Feed Table | 6. Paper Guide |
| 7. Control Panel | 8. Tension Knob | 9. Power Switch |

MyBinding.com
5500 NE Moore Court
Hillsboro, OR 97124
Toll Free: 1-800-944-4573
Local: 503-640-5920

5. CONTROL PANEL

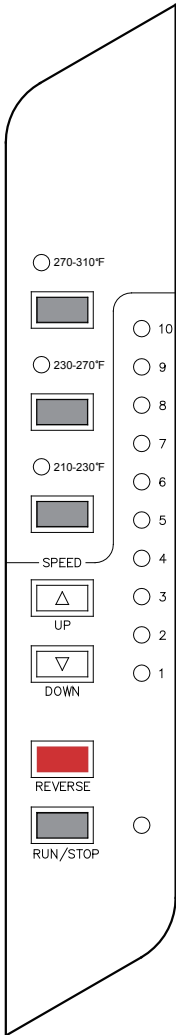

RSL-2701

$270 \sim 310^{\circ}\text{F}$

Film Application Temperature
 $270 \sim 310^{\circ}\text{F}$

$230 \sim 270^{\circ}\text{F}$

Film Application Temperature
 $230 \sim 270^{\circ}\text{F}$

$210 \sim 230^{\circ}\text{F}$

Film Application Temperature
 $210 \sim 230^{\circ}\text{F}$



Increase roller speed
(1~10 speed settings)



Reduce roller speed
(1~10 speed settings)



Reverse the rollers to undo jams and correct
misfed documents



Run and stop the machine

MyBinding.com
5500 NE Moore Court
Hillsboro, OR 97124
Toll Free: 1-800-944-4573
Local: 503-640-5920

6. FEATURES GUIDE

Power Switch ①

Located on the rear of the machine. "I" (on) "O" (off). (Fig. 2)

Cross Cutter ②

Used to cut off the laminated web. (Fig. 2)

Feed Guide ③

The feed guide permits alignment of the item(s) to be laminated. To position the adjustable guide, loosen the knob, slide it to the desired position and tighten the knob to secure the feed guide in place. (Fig. 3)

Safety Cover ④

Cover + Protect the hot rollers.

NOTE: If the safety cover is opened, this rollers stop turning.

Film Shaft and Locking Core Adapter ⑤

The film shaft holds the film supply on the machine. The locking core holds and locks the film on the shaft to prevent shifting. (Fig. 4)

Film Tension Adjustment ⑥

Allows the operator to increase or decrease roll film tension. To increase the tension turn the knob clockwise and to decrease tension turn the knob counterclockwise. (Fig. 5)

- NOTE:**
- Excess tension on the top roll feed will cause upward curl.
 - Excess tension on the bottom roll feed will cause downward curl.
 - Tension should be adjusted until the laminated materials exit flat.

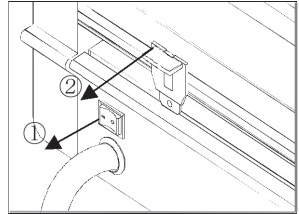

Figure 2

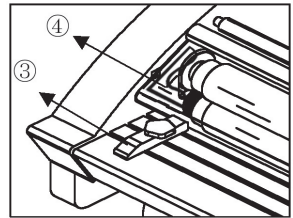

Figure 3

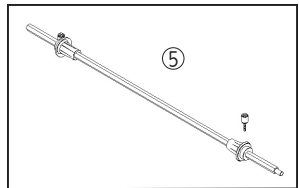

Figure 4

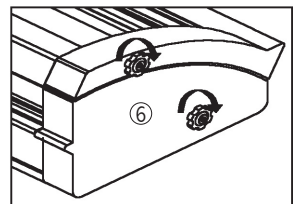

Figure 5

7. FILM LOADING & THREADING

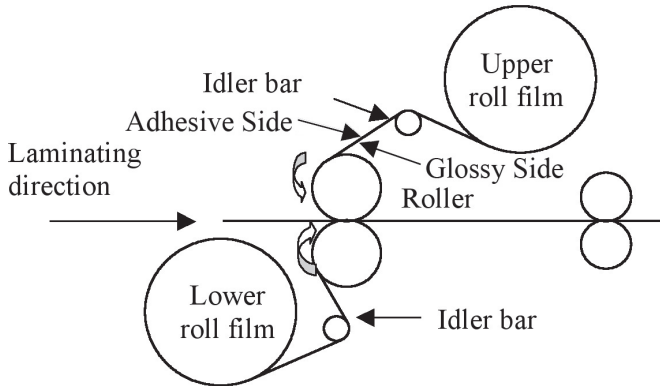

Figure 6

1. Slightly slide the upper film shaft to the right and pull it out from the machine. (Fig. 7)

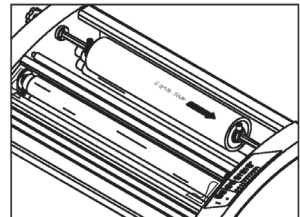

Figure 7

2. Take both lock core adapters off from the shaft. (Fig. 8)

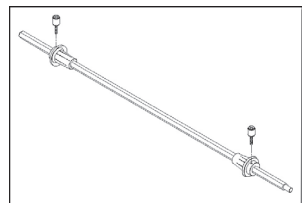

Figure 8

MyBinding.com
5500 NE Moore Court
Hillsboro, OR 97124
Toll Free: 1-800-944-4573
Local: 503-640-5920

TABLE TOP LAMINATOR

3. Insert one of the core adapters into the right end of the film core. For film with poly-in (adhesive side is inside the web), make sure the adhesive side is facing upward. (Fig. 9)

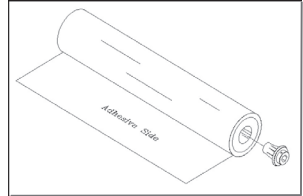

Figure 9

4. Insert the film shaft into the roll of film from the right side with the copper end last. Align and insert the core adapter on the left end of the film core. (Fig. 10)

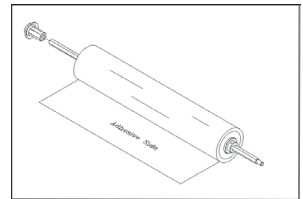

Figure 10

5. Center the film on the shaft and lock it in place with the locking core adapters. (Fig. 11)

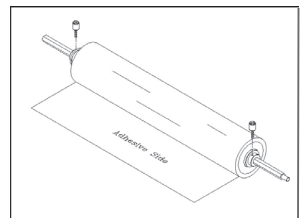

Figure 11

6. Carefully return the film shaft back into place. (Fig. 12)

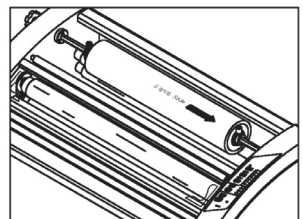

Figure 12

MyBinding.com
5500 NE Moore Court
Hillsboro, OR 97124
Toll Free: 1-800-944-4573
Local: 503-640-5920

LOADING LOWER ROLL FILM

1. Repeat steps 1-5 to load the lower roll film.
2. Once the upper and lower film is on the shaft, pull the film from the top and roll down to the bottom roll to make certain that the film is aligned properly. Then tighten the lower locking core screws.

NOTE: If the film is not aligned properly exposed adhesive will adhere to the rollers and may cause the film to jam.

FILM THREADING / WEBBING

1. Set the temperature and speed according to the Recommended Temperature and Speed section.
2. Remove the Front Table.
3. Pull down the upper film over the Safety Cover to the lower film; align and center the lower film to upper film. (Picture 1)
4. Rewind the upper film until the film aligns with the Safety Cover.
5. Thread the film over the Upper Idle Bar and underneath the Safety Cover and pull down until it drapes over both upper and lower hot rollers. (picture 2)
6. Carefully pull up the laminate from the lower roll up and drape it over top of the upper film (over the top hot roller). (picture 3)
7. Reinstall the Front Table and close the Safety Cover.
8. Insert and push the leader board into the hot rollers and press the Run button. (picture 4)
9. Press the Stop button when the leader board has completely exited the rear of the laminator.
10. Use the Cross-Cutter to remove the leader board.
11. Trim any excess film off of the leader board. The leader board can be re-used.

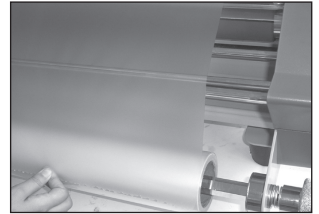

Picture 1

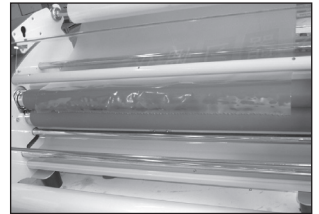

Picture 2

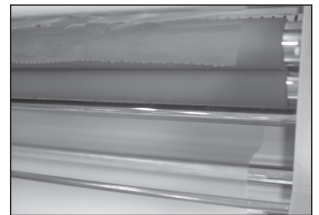

Picture 3



Picture 4

MyBinding.com
5500 NE Moore Court
Hillsboro, OR 97124
Toll Free: 1-800-944-4573
Local: 503-640-5920

8. OPERATION INSTRUCTIONS

1. Turn the laminator ON (I) located on the rear of the machine. (Fig. 2)
2. Choose appropriate laminating temperature and speed. (Fig. 1)
3. Do not begin laminating until the blinking light is steady (approximately 8 minutes).
4. Position the item to be laminated on the feed table.
5. Press the RUN button. The rollers will begin to turn, and feed the item into the machine.
6. Stop the laminator when all of the items have completely exited the rear of the machine.
7. Adjust top + bottom roll feed tension until lamination is flat.
(See film tension adjustment page 8.)

NOTE: Stand by mode and auto power off mode

- Stand by mode: If no activity is made within 30 minutes after each use the machine will automatically switch into stand by mode. (In stand-by mode the temperature will decrease to 80~90°C and the three temperature setting indicators will blink).
- Auto power off mode: If the machine is in stand by mode and no activity is made for 60 minutes the machine will automatically power off.
- If any activity is made while in stand by or auto power off mode the machine will return to it's previous stage.

MyBinding.com
5500 NE Moore Court
Hillsboro, OR 97124
Toll Free: 1-800-944-4573
Local: 503-640-5920

9. MAINTENANCE

1. Do not apply any cleaning fluids to the rollers certain fluids may cause damage.
2. Do not clean rollers with sharp or pointed objects.
3. Use a crepe rubber cleaning block to remove adhesive from rollers. Works best when rollers are hot.
4. Use a damp cloth with water to clean the body of the machine.
5. Store machine in a dry clean area.

10. TROUBLE SHOOTING GUIDE

Symptom	Cause	Possible Solution
Rollers do not operate after the RUN/ STOP button is pressed	1. Safety cover is opened 2. Power cord is not plugged in 3. Front table is not on properly 4. Machine is not turned on	1. Check safety cover is properly closed 2. Plug in the power cord 3. Check installed properly 4. Turn the machine on
Roller is not heating	Call your authorized dealer	Call your authorized dealer
Poor Lamination	1. Film tension is unbalanced. 2. Lower idler bar is not located in proper position 3. Wrong temperature / speed setting	1. Adjust film tension 2. Push idler bar in proper position 3. Follow manufacturer's recommended temperature and speed

MyBinding.com
 5500 NE Moore Court
 Hillsboro, OR 97124
 Toll Free: 1-800-944-4573
 Local: 503-640-5920

11. SPECIFICATIONS

MODEL		RSL-2701
Power supply		AC120V 60Hz
Power consumption		1450W
Max laminating width		685mm
Film thickness		25~250mic /1~10mil
Max laminating speed		2.5m/min
Ready time		10min
Heating method		Hot Roller
Driving motor		DC geared motor
Temperature control		Digital(micom)
Speed control		Digital(10steps)
Transport type		4Roller
Cross cutter		Yes
Hot lamination	Single	No
	Double	Yes
Reverse		Yes
Dimensions(w×d×h)		920×520×320mm
Unit weight		50kg

11. WARRANTY

Royal Sovereign International warrants the equipment sold is free from defects in material and workmanship for a period of One (1) year for Parts and Labor from the date of installation, excluding lamination rollers which are warranted for Six (6) months. This warranty is extended only to the original purchaser. This warranty is the only warranty made by Royal Sovereign International and cannot be modified or amended. Royal Sovereign's sole and exclusive liability and the customer's sole and exclusive remedy under this warranty shall be, at Royal Sovereign's option, to repair or replace any such defective part or product. These remedies are only available if Royal Sovereign's examination of the product discloses to Royal Sovereign's satisfaction that such defects actually exist and were not caused by misuse, neglect, attempt to repair, unauthorized alternation or modification, incorrect line voltage, fire, accident, flood or other hazard.

All warranty claims must be filed through the authorized Royal Sovereign dealer or reseller through which the equipment was originally purchased. Model, serial number and date of delivery are required for all claims.

The warranty made herein is in lieu of all other warranties, expressed or implied, including any warranty or merchantability or fitness for a particular purpose. Royal Sovereign will not be liable for personal damage or personal injury (unless primarily caused by its negligence), loss of profit, or other incidental or consequential damages arising out of the use or inability to use this equipment.

LIMITED WARRANTY

This warranty specifically does not cover damage to laminating rollers caused by knives, razor blades, or any sharp objects or abrasives, or failure caused by adhesives, or damage caused by lifting, tilting or improper use of the machine. Warranty repair or replacement by Royal Sovereign or its authorized Reseller(s) does not extend the warranty beyond the initial one year period from the date of installation. Unauthorized customer alterations will void this warranty.

MyBinding.com
5500 NE Moore Court
Hillsboro, OR 97124
Toll Free: 1-800-944-4573
Local: 503-640-5920