

# AKILES COILMAC-ECI

## Instruction Manual



Provided By

**MyBinding**.com®  
*When Image Matters.*

# CoilMac-ECI OPERATIONAL MANUAL

## INTRODUCTION

CONGRATULATIONS ON THE PURCHASE OF YOUR NEW *CoilMac-ECI*, A PROFESSIONAL AND HEAVY-DUTY COIL PUNCH AND BINDING MACHINE. YOUR *CoilMac-ECI* WAS CAREFULLY DESIGNED WITH A FULL RANGE OF FUNCTIONS AND PREMIUM QUALITY COMPONENTS TO GUARANTEE AN EFFORTLESS AND PROFESSIONAL BIND, AS WELL AS MANY YEARS OF TROUBLE-FREE SERVICE.

## IMPORTANT

WE RECOMMEND THAT YOU TAKE A FEW MINUTES TO FAMILIARIZE YOURSELF WITH THE FUNCTIONS OF YOUR NEW *CoilMac-ECI*. YOU WILL FIND THAT WITH JUST A LITTLE PRACTICE, ANYONE CAN ACHIEVE PROFESSIONAL RESULTS.

## FEATURES

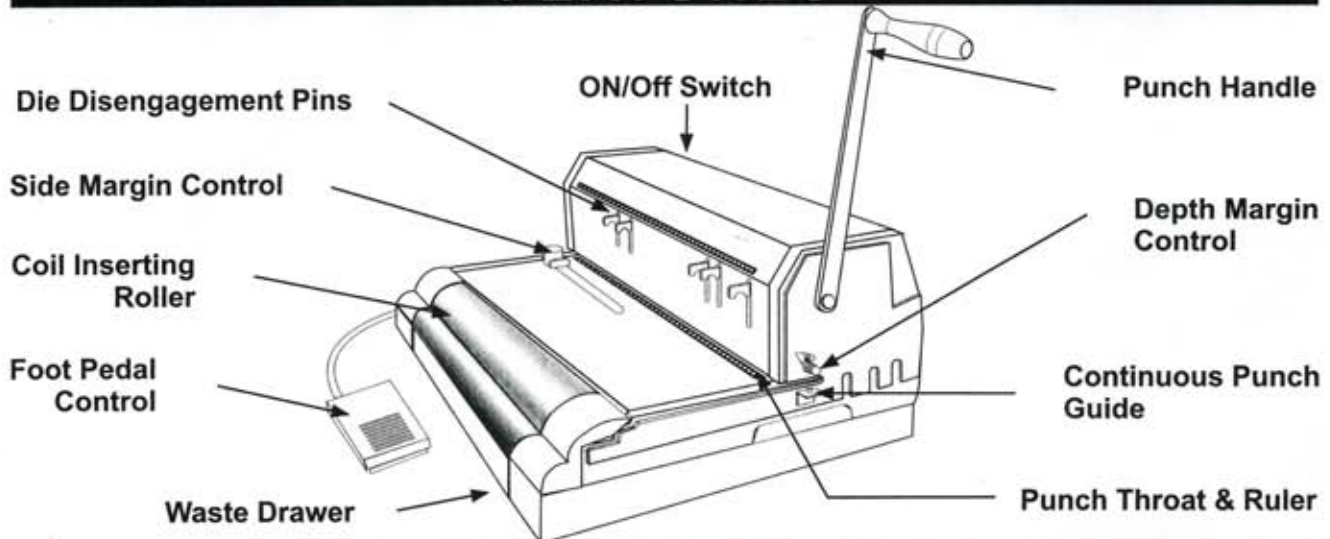

## ASSEMBLY

1. Place your new *CoilMac-ECI* on top of a sturdy working table. See picture 1
2. Remove the screw from punching axle. Insert the punch handle, in a vertical position, onto the punching axle and tighten back the screw into the punching axle ( make sure screw is well fastened *counter clockwise*). See picture 2
3. Turn on switch and press foot pedal to test inserting roller. See picture 3.

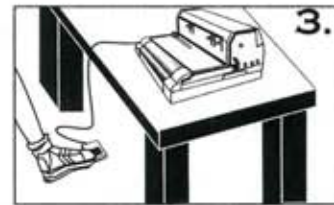
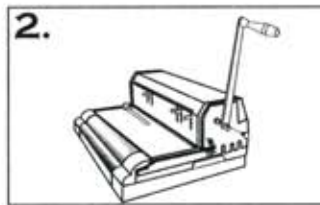
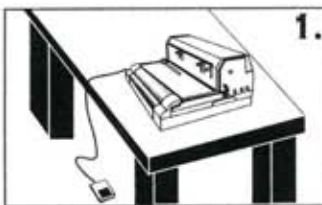

## SAFETY INSTRUCTIONS

1. Keep fingers, hair, jewelry, necktie and any loose clothing or objects away from roller, as they may be accidentally pulled into the roller.
2. Do not allow children to operate the machine. The *CoilMac-ECI* is not a toy.
3. Always turn switch-off and place foot pedal out of reach when machine is not in use.
4. To reduce the risk of electric shock, never operate the *CoilMac-ECI* near water.
5. Do not use the *CoilMac-ECI* if power cord is damaged.
6. Do not allow the electric cord to be in contact with hot surfaces.
7. In case of malfunction, return the unit to your distributor for service. This equipment does not contain any part that can be serviced by the consumer or operator.



## FOR PUNCHING DOCUMENT 14" (356MM) OR LARGER

1. Align Sheets as indicated on Punch Throat Ruler. Make sure all Die Disengagement Pins are pushed in.
2. Insert sheets and pull handle forward to punch. See Picture 1
3. Remove sheets and flip them over as illustrated. See Picture 2.
4. Insert sheet from right-hand-side. Pull the handle forward and punch. See picture 3.

**IMPORTANT:** Document must be inserted in such a way as to place one of the already perforated holes onto the **Continuous Punch Guide**. Make sure that the last hole ( Document edge), if partially covered by the Punch Throat & Ruler, is aligned to a disengaged die, otherwise your document will be left partially perforated.

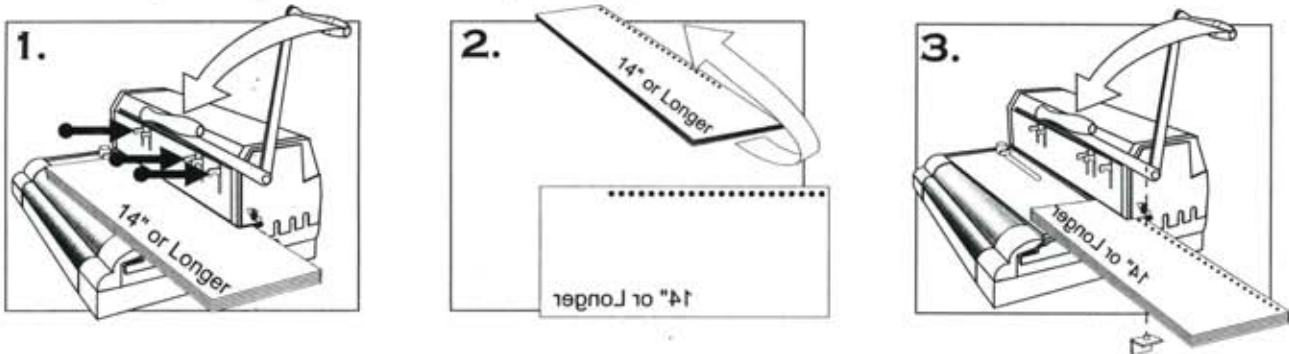

### REMARKS:

- a). When using your **CoilMac-ECI** for the first time, punch a few waste sheets. This will clean-off any excess oil on the punching dies.
- b). Recommended number of sheets per punch: 12-15 ( 20lbs paper)
- c). Maximum recommended single punching capacity: 17 sheets ( 20 lbs paper)

## COIL INSERTING ( BINDING )

1. Align punched document and place it on top of machine or table. Insert the coil into the first 4 to 5 holes.  
See picture 1
2. Hold document evenly against roller ( coil must slightly touch the roller ).  
See picture 2
3. Press foot pedal. The coil will automatically move forward inserting itself into the holes.  
See picture 2
4. After the last hole insertion, IMMEDIATELY move document away from roller and/or stop pressing the foot pedal. Remark: if coil is over inserted or some pages are un-inserted, simply flip document over and proceed with insertion as per step 2.
5. Use crimpers to cut & crimp the excess coil. Make sure you crimp-in both ends. This procedure will prevent the document from unbinding itself. See picture 3

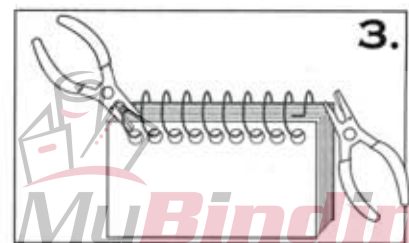
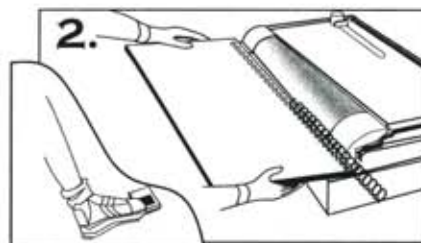
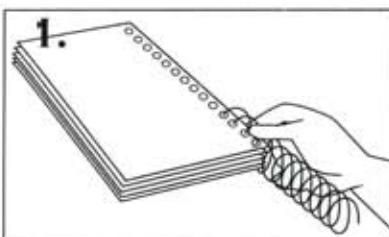

# SET-UP

1. Use Coil Size Guide to determine the correct:

- ☞ Depth Margin
- ☞ Coil Diameter

See Picture 1

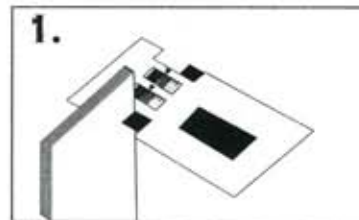

2. To adjust the correct Punching Margin, press and rotate the Depth Margin Control. See Picture 2

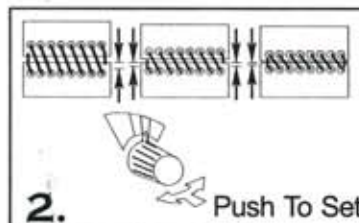

3. ( OPTIONAL) You may use the Coil Diameter Selector to determine or double check that you are using the correct coil diameter for your document. See Picture 3

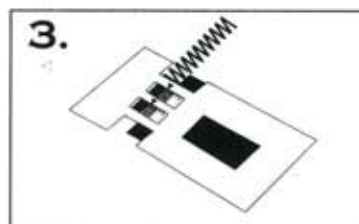

## HINT

To properly adjust the depth margin, press and rotate the Depth Margin Control at the same time. Release it upon reaching the desired position. **The Depth Margin Control button must bounce-back upon release.** If it does not bounce-back, rotate it slightly back and forth until it does so. See picture 4

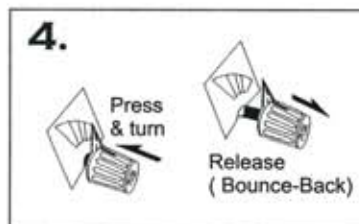

# PUNCHING

1. Use the Punch Throat Ruler and Side Margin Control to center the punching of your document. See Picture 1 & 2. **HINT:** Insert a sheet and make sure you disengage any hole that is left partially exposed on the Punch Throat Ruler. Failing to do so, will leave a partially perforated hole at the edge of your document.

2. Insert sheets and pull handle toward you to punch. See picture 3

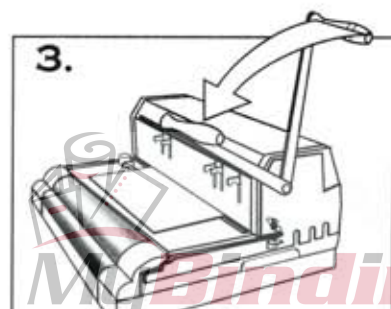
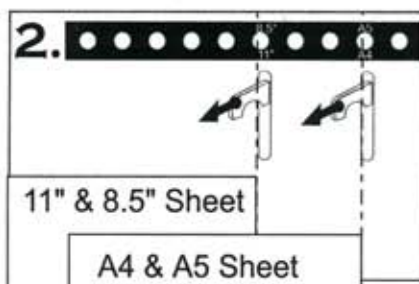
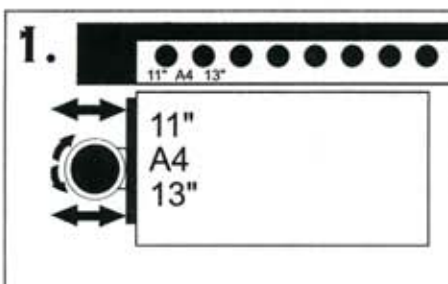

# TECHNICAL INFORMATION

## CoilMac-ECI

### BINDING FORMAT

Legal (14" or 356 mm)  
Oficio (13" or 330 mm)  
A4 (11.69" or 297 mm)  
Letter (11" or 279 mm)  
A5 ( 8.27" or 210 mm)  
1/2 Letter (8.5" or 215.9 mm)

### SIZE 4:1

= 53 + 2 holes  
= 53 holes  
= 46 holes  
= 43 holes  
= 33 holes  
= 32 holes

### SIZE 6 mm

= 55 + 2 holes  
= 54 holes  
= 49 holes  
= 46 holes  
= 34 holes  
= 35 holes

### SIZE 5:1

= 65 + 5 holes  
= 65 holes  
= 59 holes  
= 55 holes  
= 41 holes  
= 42 holes

### CAPACITY & DIAMETER

No. Sheets (20 lbs)	DOCUMENT		COIL mm	No. Sheets (20 lbs)	DOCUMENT		COIL mm
	inch	mm			inch	mm	
25	1/8"	3.2 mm	5 mm	180	3/4"	19.0 mm	20 mm
35	5/32"	4.0 mm	6 mm	200	25/32"	19.8 mm	22 mm
45	3/16"	4.8 mm	7 mm	230	7/8"	22.2 mm	25 mm
60	1/4"	6.4 mm	8 mm	250	1"	25.4 mm	28 mm
70	9/32"	7.2 mm	9 mm	280	1-1/16"	27.0 mm	30 mm
80	5/16"	7.9 mm	10 mm	300	1-1/8"	28.5 mm	32 mm
100	13/32"	10.3 mm	12 mm	350	1-5/16"	33.3 mm	38 mm
120	15/32"	11.9 mm	14 mm	400	1-9/16"	39.7 mm	45 mm
150	19/32"	15.0 mm	17 mm	450	1-7/8"	47.5 mm	50 mm

## WARRANTY POLICY

YOUR **CoilMac-ECI** HAS A WARRANTY OF ONE YEAR FROM DATE OF PURCHASE. IN THE EVENT OF A MANUFACTURER'S DEFECT, YOUR DISTRIBUTOR (AT OPTION) WILL REPAIR OR REPLACE IT. IMPORTANT: THIS WARRANTY DOES NOT COVER DAMAGES DUE TO IMPROPER USE OR MISS TREATMENT OF THE UNIT, INCLUDING ANY EXTRAORDINARY EVENT LEADING TO THE DAMAGE OF THE MACHINE, WHETHER IT IS REVERSIBLE OR NOT.

IF THE **CoilMac-ECI** IS NOT WORKING PROPERLY, FIRST FOLLOW THE CORRECTIVE ACTIONS ABOVE. IF THE PROBLEM PERSISTS, PLEASE CONTACT YOUR DEALER FOR FURTHER INSTRUCTIONS. PLEASE HAVE YOUR MACHINE'S SERIAL NUMBER AND THE PURCHASE DATE READY. IF THE MACHINE MUST BE RETURNED TO YOUR DISTRIBUTOR, IT IS YOUR RESPONSIBILITY TO PROPERLY PACK AND SHIP IT. AS ANY DAMAGES INCURRED DURING ITS TRANSPORTATION IS NOT COVERED BY OUR WARRANTY POLICY.