

Akiles WireMac E Electric Wire Binding Machine

Instruction Manual

For Models:

WireMac E 2:1

WireMac E 3:1



Provided by

MyBinding.com
When Image Matters.

Call Us at 1-800-944-4573

WIREMAC-E OPERATIONAL MANUAL

INTRODUCTION

CONGRATULATIONS ON THE PURCHASE OF YOUR NEW **WIREMAC-E**, A PROFESSIONAL AND HEAVY-DUTY WIRE PUNCH AND BINDING MACHINE. YOUR **WIREMAC-E** WAS DESIGNED WITH A FULL RANGE OF FUNCTION AND PREMIUM QUALITY COMPONENTS TO GUARANTEE YOU AN EFFORTLESS AND PROFESSIONAL BIND, AS WELL AS MANY YEARS OF TROUBLE-FREE SERVICE.

IMPORTANT

WE RECOMMEND THAT YOU TAKE A FEW MINUTES TO FAMILIARIZE YOURSELF WITH THE FUNCTIONS OF YOUR NEW **WIREMAC-E**. YOU WILL FIND THAT WITH JUST A LITTLE PRACTICE, ANY PERSON CAN ACHIEVE PROFESSIONAL RESULTS.

FEATURES

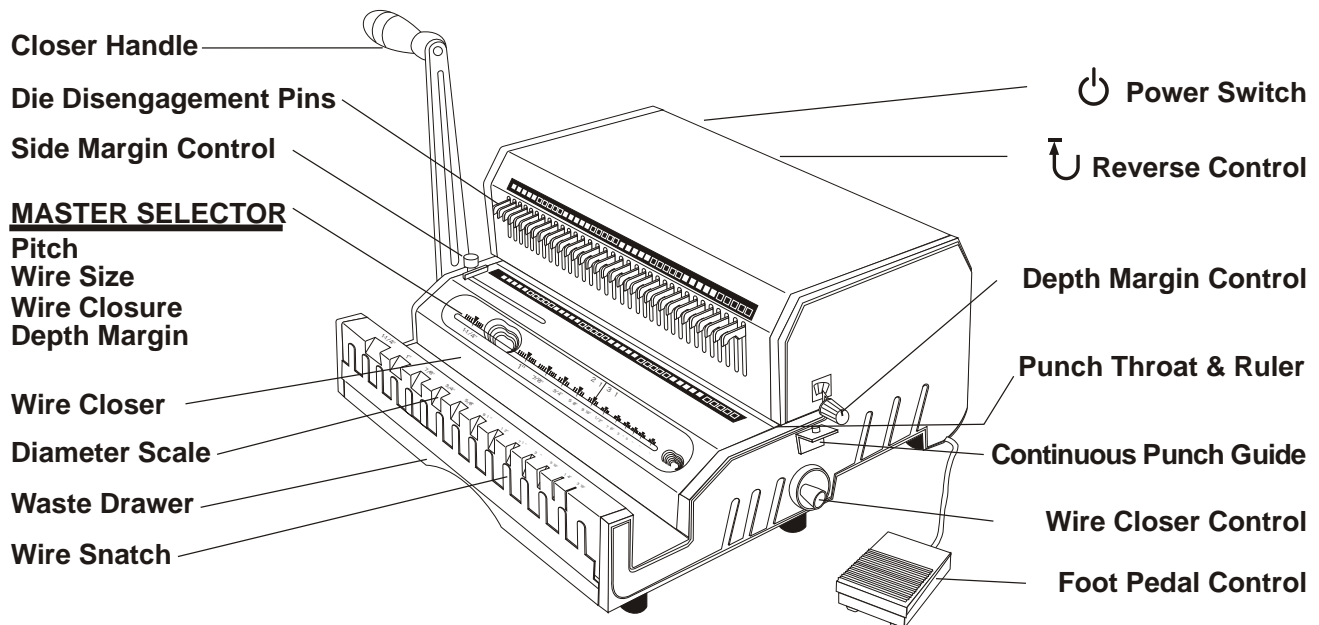

ASSEMBLY & SAFETY INSTRUCTION

1. Place your new **WIREMAC-E** on top of a sturdy working table. [See picture 1](#)
2. Plug the power cord and foot pedal cord to the back of machine [See picture 2](#)
3. Remove the screw from Closing Axle **clockwise** as indicated, connect the **Closing Handle** in a vertical position onto the Closing Axle. Tighten-back the screws counter clockwise. [See picture 3.](#)
4. Turn on Power switch and press foot pedal to test punching . [See picture 4.](#)

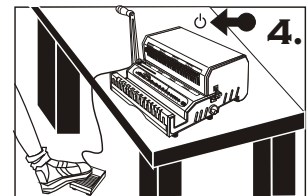
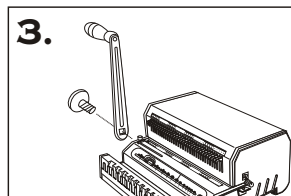
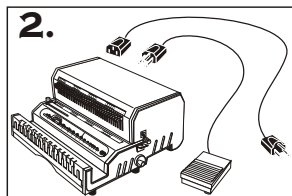
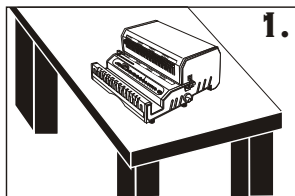

5. Always turn switch-off and place Foot Pedal out of reach when machine is not in use.
6. To reduce the risk of electric shock, never operate the **WIREMAC-E** near water.
7. Do not use the **WIREMAC-E** if power cord is damaged.
8. Do not allow the electric cord to be in contact with hot surfaces.
9. In case of malfunction, return the unit to your distributor for service. This equipment does not contain any part that can be serviced by the consumer or operator.

SET-UP

Insert a full unbound document into **Diameter Scale**.

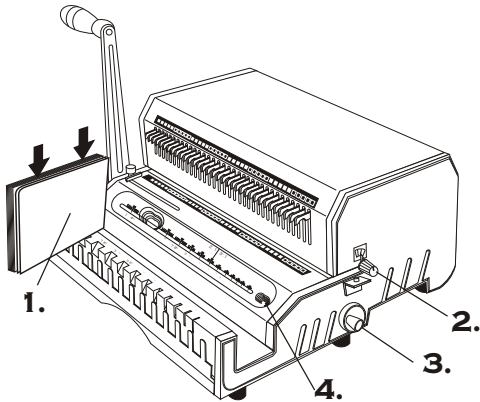

1. Based on **Diameter Scale** reading, on the **Master Selector** you will see :
 - Depth Margin
 - Wire Closure
 - Wire Size

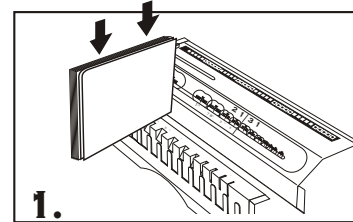

2. Set **Depth Margin Control** to the color determined from Step 1. Color indicated on **Depth Margin Control** should match color on **Master Selector**.

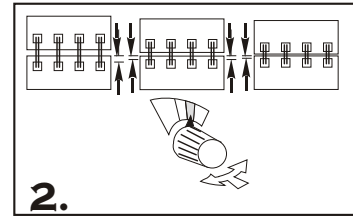

3. Set **Wire Closer Control** to the wire closure size determined from Step 1.

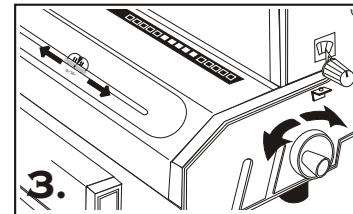

4. (If needed) Use **Master Selector** to identify the size of your wire.

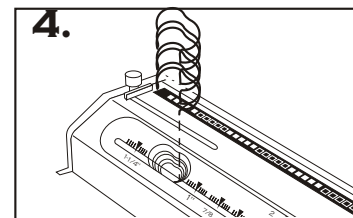

PUNCHING

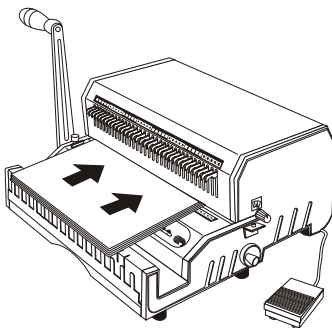

TIPS

Maximum single punching capacity:
23 sheets (20 lbs paper)

Recommended number of sheets per punch (for maximum equipment durability): 15 sheets (20 lbs paper)

Empty the Waster Drawer from time to time. Overfilled Waste Drawer may cause machine to malfunction.

IN CASE OF PAPER JAM

The punching action will automatically stop in case the punch sheets are overloaded or too heavy. When this occurs, simply press the Reverse Button in the back of the machine repeatedly, until all the punching dies return to their original, home position. Now you can pull out some of the sheets and re-start the punching action by pressing the Foot Pedal again.

1. Align **Side Margin Control** to proper sheet & cover size.
Note: There are different side margins for 11" sheets & their 11-1/4" covers.
2. Pull out **Disengagement Pins** to avoid partially punched holes.
3. Insert sheets and press foot pedal to punch.

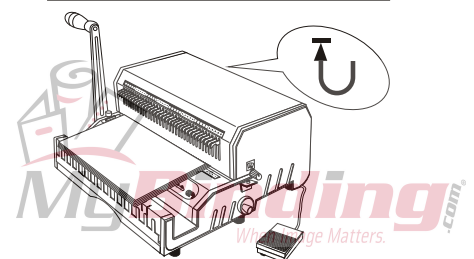
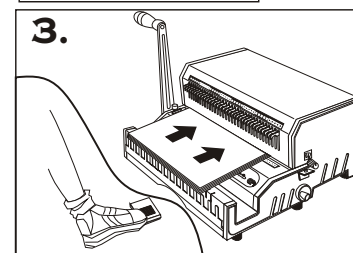
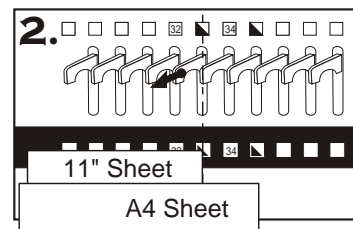
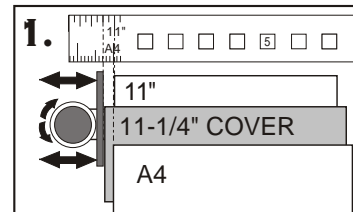

FOR PUNCHING DOCUMENT LARGER THAN 14" (356MM)

1. Align sheets as indicated on punch throat ruler. Make sure all dies disengagement pins are pushed in. Insert sheets and press Foot Pedal to punch the left part first. **See Picture 1**
2. Remove sheets and flip them over as illustrated. **See Picture 2.**
3. Insert sheet from right-hand-side. Press Foot Pedal to punch. **See picture 3.** **IMPORTANT:** Document must be inserted in such a way as to place one of the already perforated holes onto the **Continuous Punch Guide**.

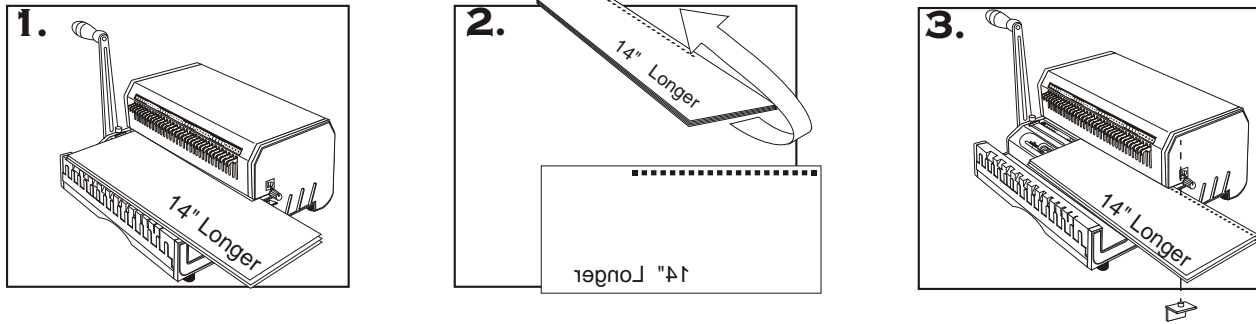

INSERTING

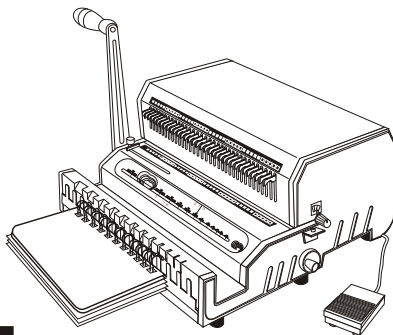

TIPS

The seam of closed wire should be inside the book. Follow step No.2 instruction for best results.

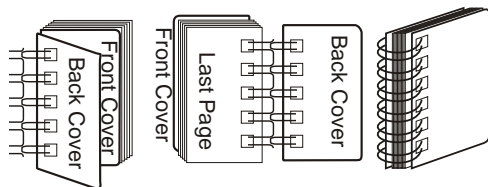

1. Insert pre-selected wire into **Wire Snatch**

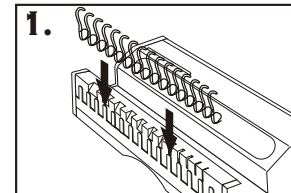

2. Insert document from last pages to first pages then insert front cover. The back cover should be inserted last with inside facing up.

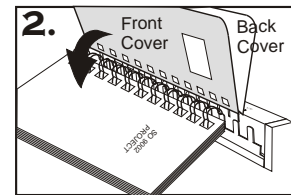

3. Take out inserted document from **Wire Snatch** to close the wire.

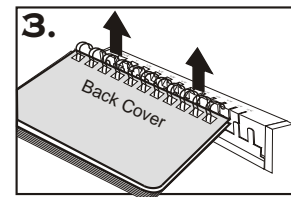

CLOSING

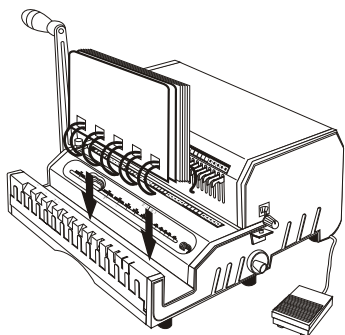

TIPS

The seam of closed wire should be just touching. Slightly adjust the **Closer Control** a little left or right for the under-closed or over-closed seam.

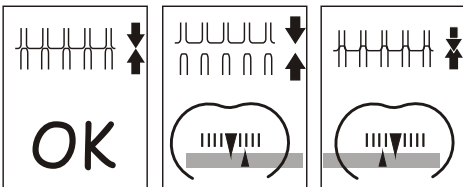

1. Put inserted document into **Wire Closer**. The wire element must stand horizontally at the bottom of **Wire Closer**.

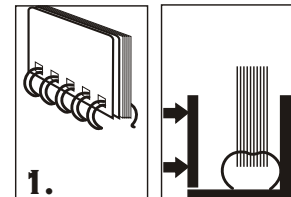



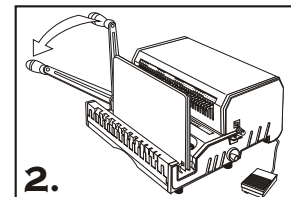



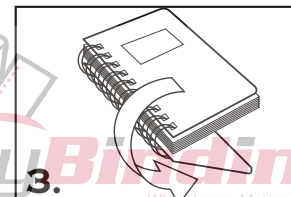















2. Pull **Closer Handle** forward to close.



3. Take out document and turn back cover over. The binding is complete.



TECHNICAL INFORMATION

Size	Size 3 : 1 (3 HOLES PER INCH) 	Size 2 : 1 (2 HOLES PER INCH) 																																																		
Punching Length	14" = 40 Holes LEGAL = 38 Holes A4 = 34 Holes 11" = 32 Holes 8.5" = 24 Holes A5 = 24 Holes	14" = 27 Holes LEGAL = 26 Holes A4 = 23 Holes 11" = 21 Holes 8.5" = 16 Holes A5 = 16 Holes																																																		
Binding Capacity	<table style="width: 100%; border-collapse: collapse;"> <thead> <tr> <th style="text-align: left;">Sheets 70-80 g/m²</th> <th style="text-align: left;">Diameters Inch</th> <th style="text-align: left;">mm</th> <th></th> </tr> </thead> <tbody> <tr><td>20</td><td>3/16</td><td>4.5</td><td></td></tr> <tr><td>30</td><td>1/4</td><td>6</td><td></td></tr> <tr><td>50</td><td>5/16</td><td>8</td><td></td></tr> <tr><td>60</td><td>3/8</td><td>9</td><td></td></tr> <tr><td>80</td><td>7/16</td><td>10</td><td></td></tr> <tr><td>100</td><td>1/2</td><td>12</td><td></td></tr> <tr><td>120</td><td>9/16</td><td>15</td><td></td></tr> </tbody> </table>	Sheets 70-80 g/m ²	Diameters Inch	mm		20	3/16	4.5		30	1/4	6		50	5/16	8		60	3/8	9		80	7/16	10		100	1/2	12		120	9/16	15		<table style="width: 100%; border-collapse: collapse;"> <thead> <tr> <th style="text-align: left;">Sheets 70-80 g/m²</th> <th style="text-align: left;">Diameters Inch</th> <th style="text-align: left;">mm</th> </tr> </thead> <tbody> <tr><td>140</td><td>5/8</td><td>16</td></tr> <tr><td>160</td><td>3/4</td><td>19</td></tr> <tr><td>190</td><td>7/8</td><td>22</td></tr> <tr><td>220</td><td>1</td><td>25</td></tr> <tr><td>280</td><td>1-1/4</td><td>32</td></tr> </tbody> </table>	Sheets 70-80 g/m ²	Diameters Inch	mm	140	5/8	16	160	3/4	19	190	7/8	22	220	1	25	280	1-1/4	32
Sheets 70-80 g/m ²	Diameters Inch	mm																																																		
20	3/16	4.5																																																		
30	1/4	6																																																		
50	5/16	8																																																		
60	3/8	9																																																		
80	7/16	10																																																		
100	1/2	12																																																		
120	9/16	15																																																		
Sheets 70-80 g/m ²	Diameters Inch	mm																																																		
140	5/8	16																																																		
160	3/4	19																																																		
190	7/8	22																																																		
220	1	25																																																		
280	1-1/4	32																																																		

WARRANTY POLICY

YOUR **WIREMAC-E** HAS A WARRANTY OF ONE YEAR FROM DATE OF PURCHASE. IN THE EVENT OF A MANUFACTURER'S DEFECT, YOUR DISTRIBUTOR (AT OPTION) WILL REPAIR OR REPLACE IT. IMPORTANT: THIS WARRANTY DOES NOT COVER DAMAGES DUE TO IMPROPER USE OR MISS TREATMENT OF THE UNIT, INCLUDING ANY EXTRAORDINARY EVENT LEADING TO THE DAMAGE OF THE MACHINE, WHETHER IT IS REVERSIBLE OR NOT.

IF THE **WIREMAC-E** IS NOT WORKING PROPERLY, FIRST FOLLOW THE CORRECTIVE ACTIONS ABOVE. IF THE PROBLEM PERSISTS, PLEASE CONTACT YOUR DEALER FOR FURTHER INSTRUCTIONS. PLEASE HAVE YOUR MACHINE'S SERIAL NUMBER AND THE PURCHASE DATE READY. IF THE MACHINE MUST BE RETURNED TO YOUR DISTRIBUTOR, IT IS YOUR RESPONSIBILITY TO PROPERLY PACK AND SHIP IT. AS ANY DAMAGES INCURRED DURING ITS TRANSPORTATION IS NOT COVERED BY OUR WARRANTY POLICY.