

Best-Rite New-Rite 4' x 8' ***Whiteboard Resurfacing Vinyl Roll***

Instruction Manual



Provided by

MyBinding.com
When Image Matters.

Call Us at 1-800-944-4573

1 Read through instructions from beginning to end before starting this Installation.

2 Clean boards surface thoroughly.

3 Accurately measure the surface area to be covered with a tape measure.

READ THROUGH INSTRUCTIONS FROM BEGINNING TO END **BEFORE** STARTING THIS INSTALLATION.

NOTE: THIS INSTALLATION REQUIRES TWO PEOPLE.

Use the Sponge (P-2) dipped in a Mixture of Water and Alcohol to clean the surface being covered and to aid in positioning and moving the New-Rite Surface. This mixture will dry without effecting the bond.

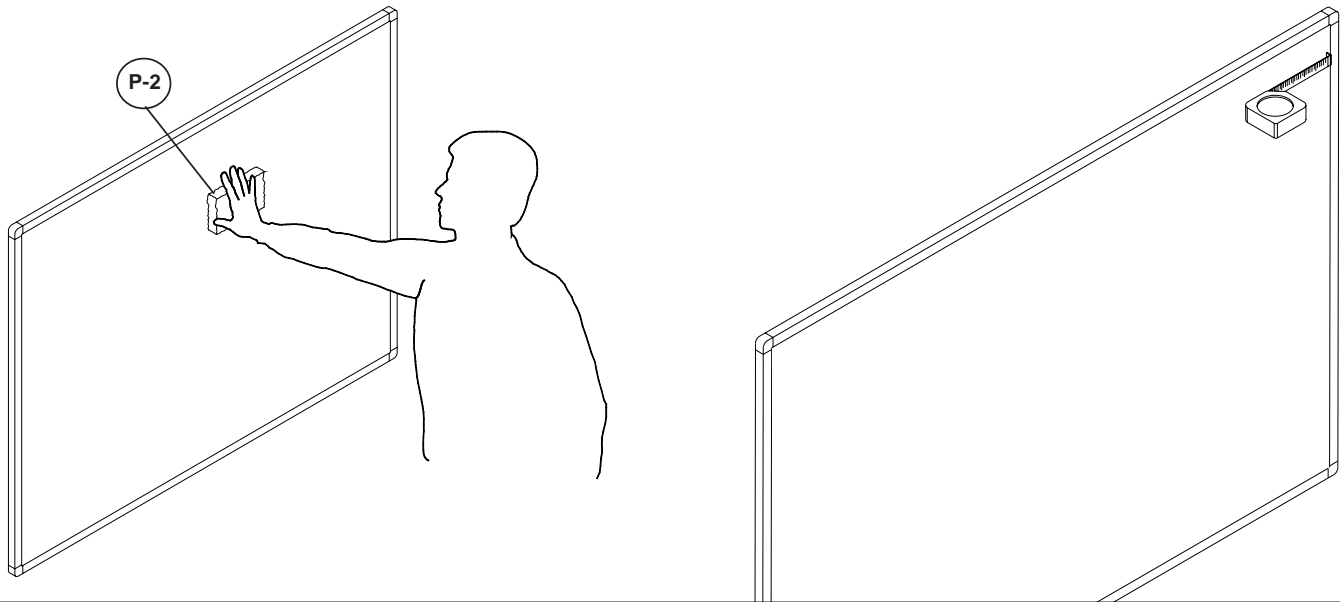

4 Cut your New-Rite Surface (P-1) to exactly fit the surface area using a utility knife.

5 Test fit the New-Rite Surface.

Start on the left hand side of the board. Start peeling the protective backer to expose the adhesive back.

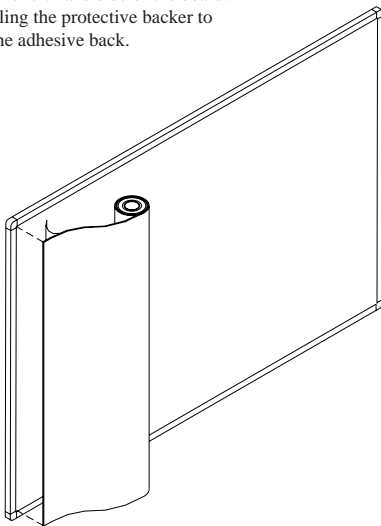
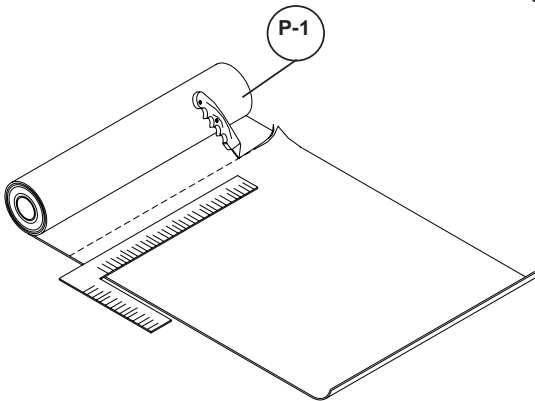

Parts List

P1		New-Rite Surface	1 Roll
P2		Sponge	1 EA
P3		Squeegee	1 EA

Recommended Tools

- Measuring Tape
- Carpenter's Square
- Utility Knife
- Roller



#214 New-Rite Installation

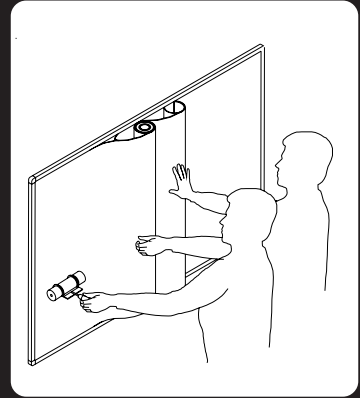

Align the New-Rite with the left side edge making sure you are straight with the top and bottom edges.

Slowly remove the protective bacer as you start pressing the New-Rite surface to the board. Take care not to trap air bubbles under the surface. Slowly work to the right side of the board.

Use the Squeegee (P-3) to press the New-Rite down and force air bubbles out.

A Roller can be used to help work out any wrinkles or air bubbles.

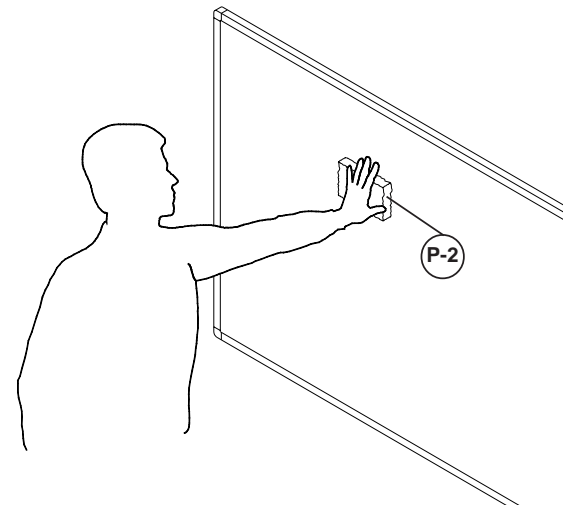
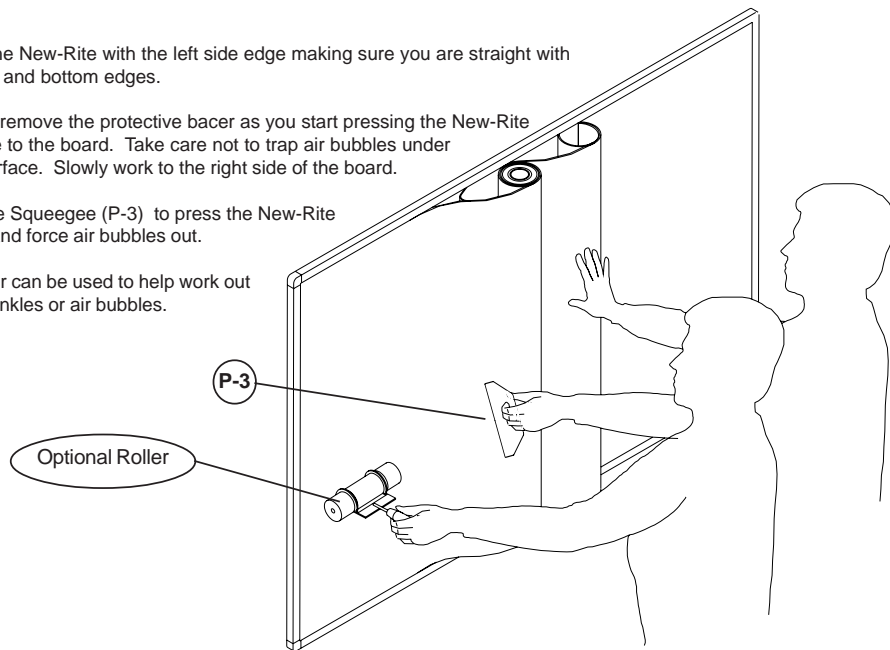

Use the Sponge (P-2) with soap and water to clean and remove all residue on the surface.

