

# ***Best-Rite 2' Best-Bite Tackless Paper Holder - 6pk***

Instruction Manual



*Provided by*

**MyBinding.com**

*When Image Matters.*

Call Us at 1-800-944-4573

# BESTBITE-12-NL

TO USE:  
Slide Paper Up  
Under Rollers

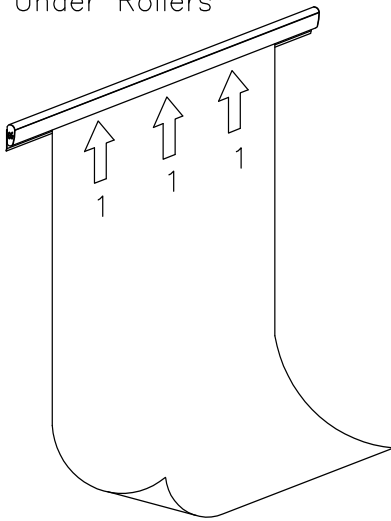

TO REMOVE PAPER:  
Lift Paper Up And  
Slide Out

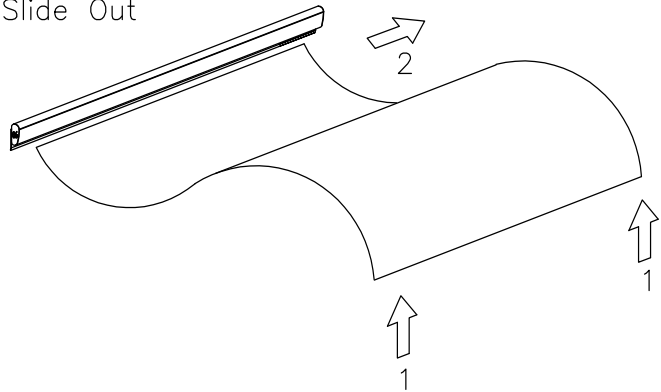

## Part List

P1



Best-Bite

1 EA

## Hardware List

A



Mounting Bracket

6

EA

B



Screw

6

EA

C



Screw Anchor-Concrete

6

EA

D



Magnet Strip

None

E



Double Sided Tape

6

EA

***Should you require assistance during assembly, please call our Customer Service Department Monday- Friday 8 a.m.-5 p.m. CST 1-800-749-2258***

## There are Two Ways to Install Your New Best-Bite.

### Option One

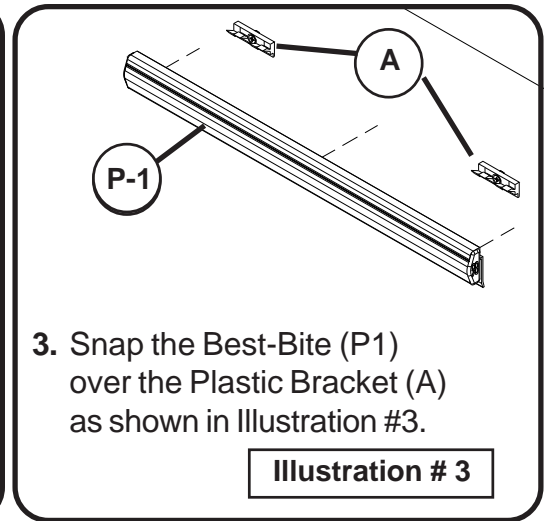
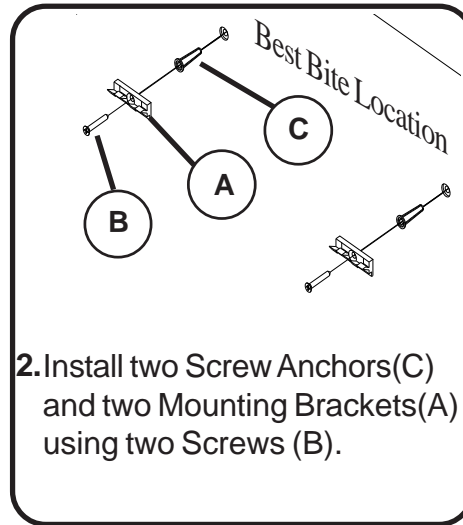
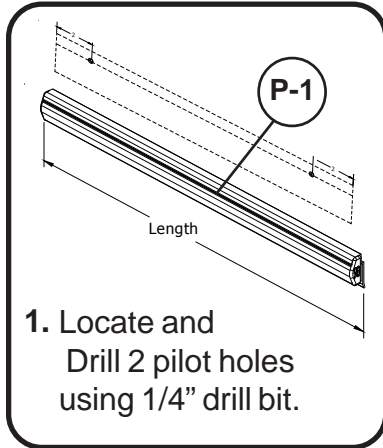

### Option Two

