

Best-Rite 6' Best-Bite Tackless Paper Holder - 6pk

Instruction Manual



Provided by

MyBinding.com

When Image Matters.

Call Us at 1-800-944-4573

BESTBITE-12-NL

TO USE:
Slide Paper Up
Under Rollers

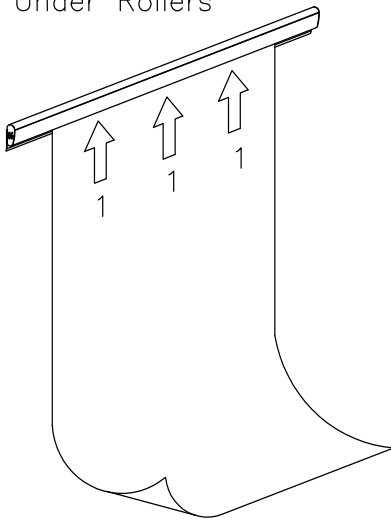

TO REMOVE PAPER:
Lift Paper Up And
Slide Out

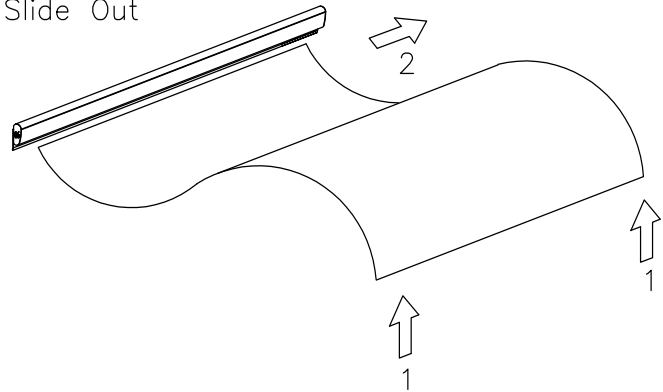

Part List





P1

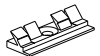

Best-Bite

1 EA

Hardware List

A		Mounting Bracket	6	EA
B		Screw	6	EA
C		Screw Anchor-Concrete	6	EA
D		Magnet Strip	None	
E		Double Sided Tape	6	EA

***Should you require assistance
during assembly, please call our
Customer Service Department
Monday- Friday 8 a.m.-5 p.m. CST
1-800-749-2258***

There are Two Ways to Install Your New Best-Bite.

Option One

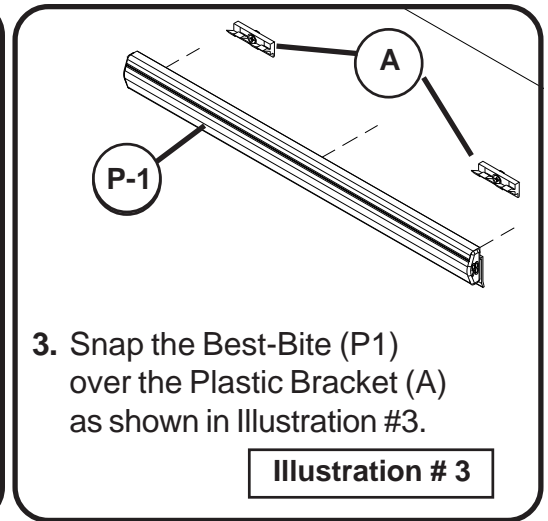
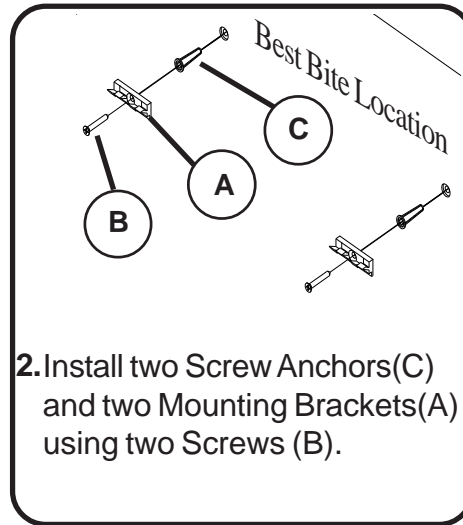
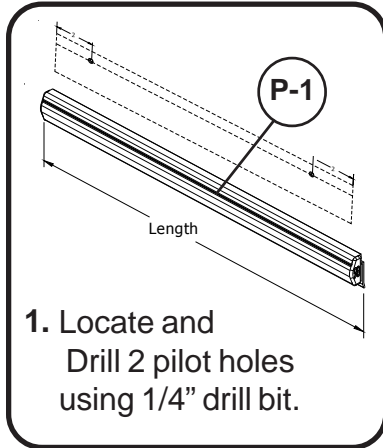

Option Two

