

Best-Rite 8' Best-Bite Tackless Paper Holder - 4pk

Instruction Manual



Provided by

MyBinding.com

When Image Matters.

Call Us at 1-800-944-4573

BESTBITE-12-NL

TO USE:
Slide Paper Up
Under Rollers

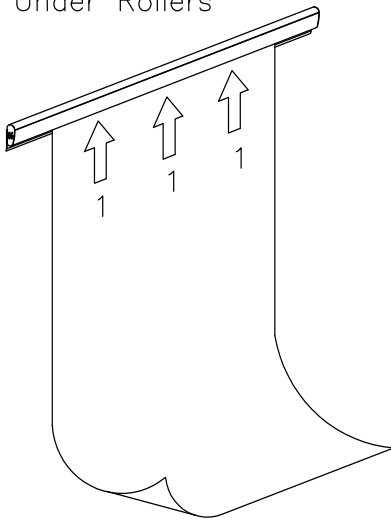

TO REMOVE PAPER:
Lift Paper Up And
Slide Out

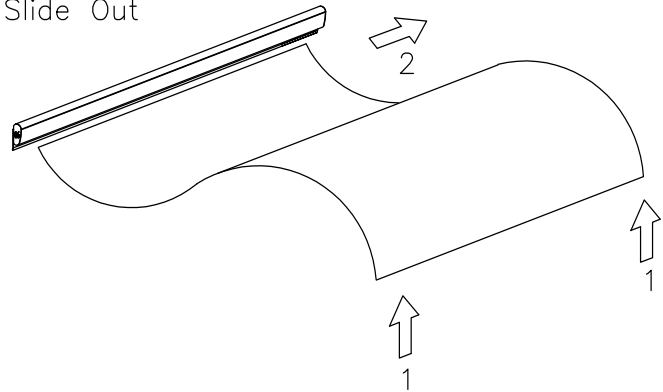

Part List

P1



Best-Bite

1 EA

Hardware List

A



Mounting Bracket

6

EA

B



Screw

6

EA

C



Screw Anchor-Concrete

6

EA

D



Magnet Strip

None

E



Double Sided Tape

6

EA

***Should you require assistance
during assembly, please call our
Customer Service Department
Monday- Friday 8 a.m.-5 p.m. CST
1-800-749-2258***

There are Two Ways to Install Your New Best-Bite.

Option One

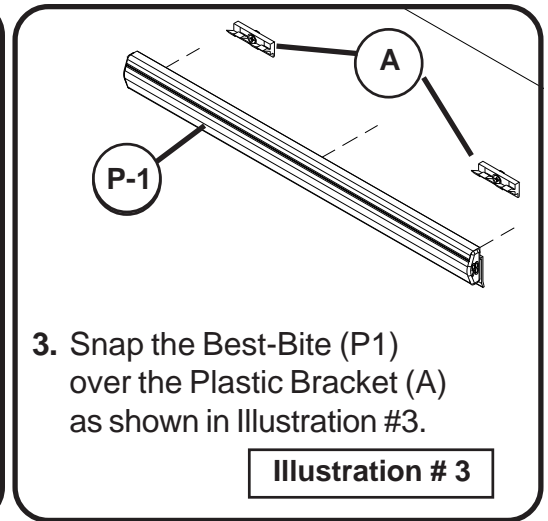
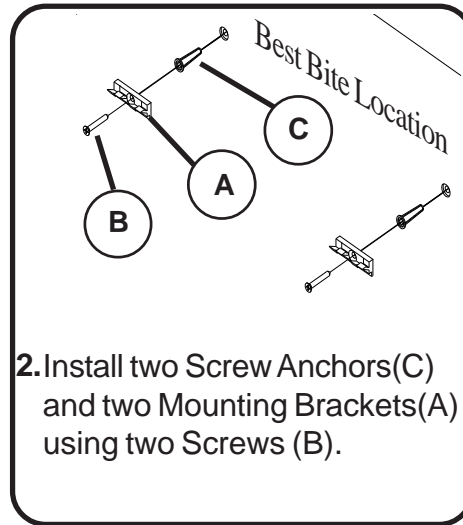
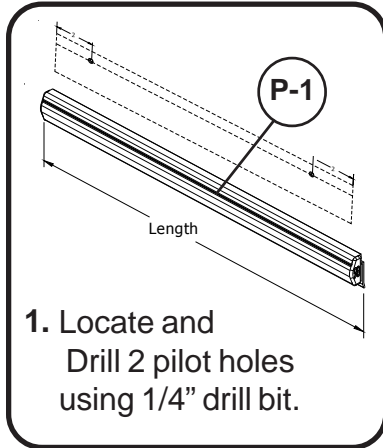

Option Two

