

Best-Rite 4' x 8' Deluxe

***Reversible Porcelain Whiteboard /
Cork Board with Aluminum Frame***

Instruction Manual



Provided by

MyBinding.com
When Image Matters.

Call Us at 1-800-944-4573

1 Attach 2 Locking Casters (E) and 2 Non-Locking Casters (F) to Legs (P-1) as shown.

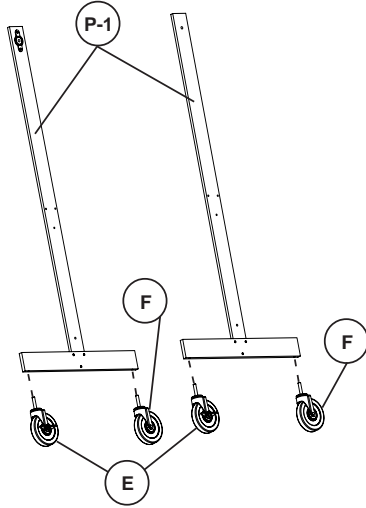

Tighten Casters using Caster Wrench (G).

2 Attach Cross Brace (P-3) to Legs (P-1) using 2 Screws (A).

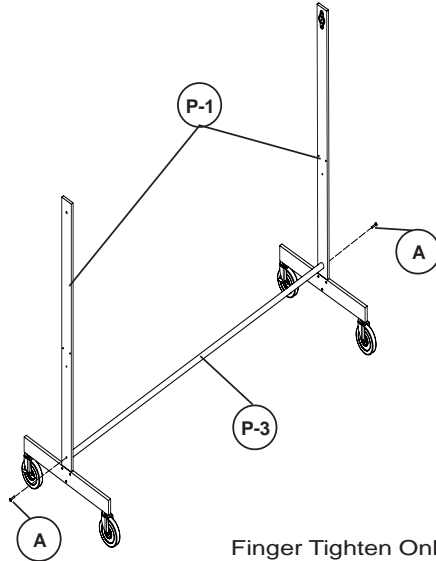

Finger Tighten Only!

READ THROUGH INSTRUCTIONS FROM BEGINNING TO END BEFORE STARTING TO ASSEMBLE UNIT.

Missing Parts or UPS Damaged Parts
 For Your Convenience you can
 EMAIL us at
boards@bestrite.com
 24HOURS 7 DAYS A WEEK

Hardware List

A		Phillips Screw	2 EA
B		Phillips Drill Screw	6 EA
C		Flange	2 EA
D		Knob	2 EA
E		3" Locking Caster	2 EA
F		3" Non-Locking Caster	2 EA
G		Caster Wrench	1 EA

3 Remove 2 Screws from each side of Framed Board (P4).

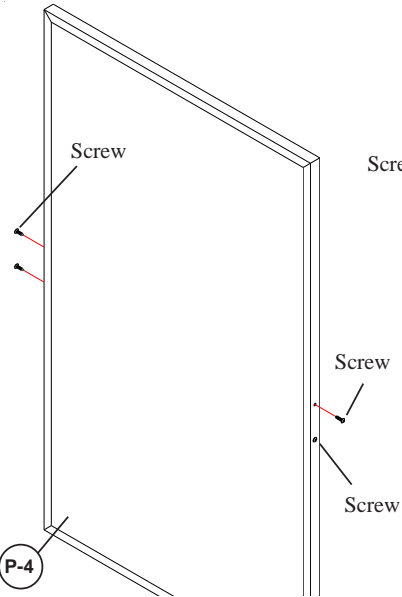

4 Attach 2 Flanges (C) to the Framed Board (P-4) using 4 Screws removed in Step #3.

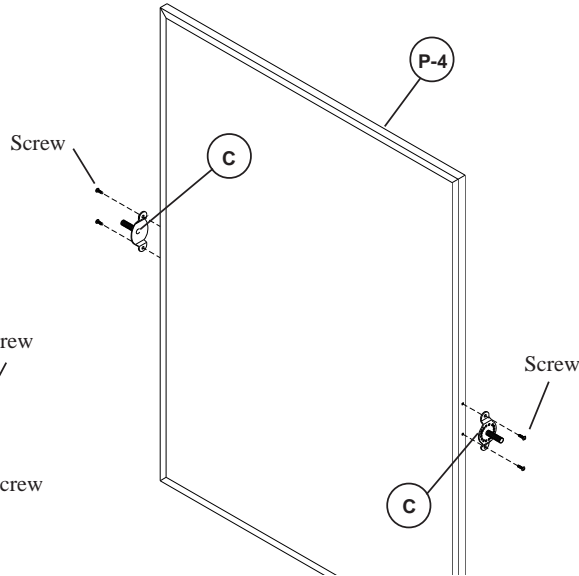

Parts List

P-1		Leg	2 EA
P-2		Tray	1 EA
P-3		Cross Brace	1 EA
P-4		Framed Board	1 EA



#668AC, AF & AG
 Aluminum Reversible

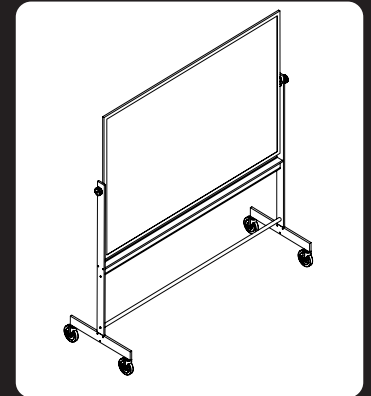

5 Spread the frame assembly at the top and insert the Framed Board(P-4) between Legs(P-1) and attach Flanges (C) to the legs using 2 Knobs (D).

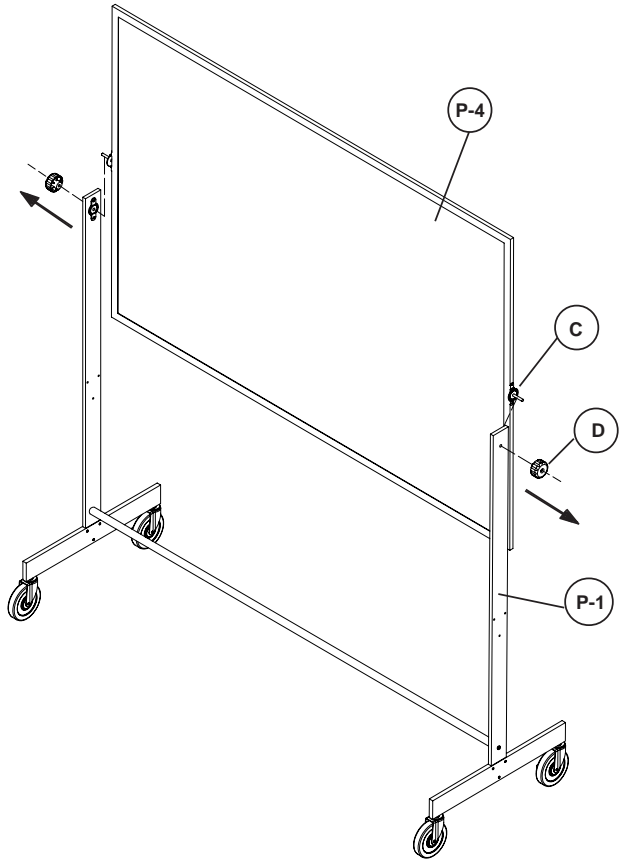

6 Assemble Tray (P-2) to Legs (P-1) using 6 Drill Screws (B).

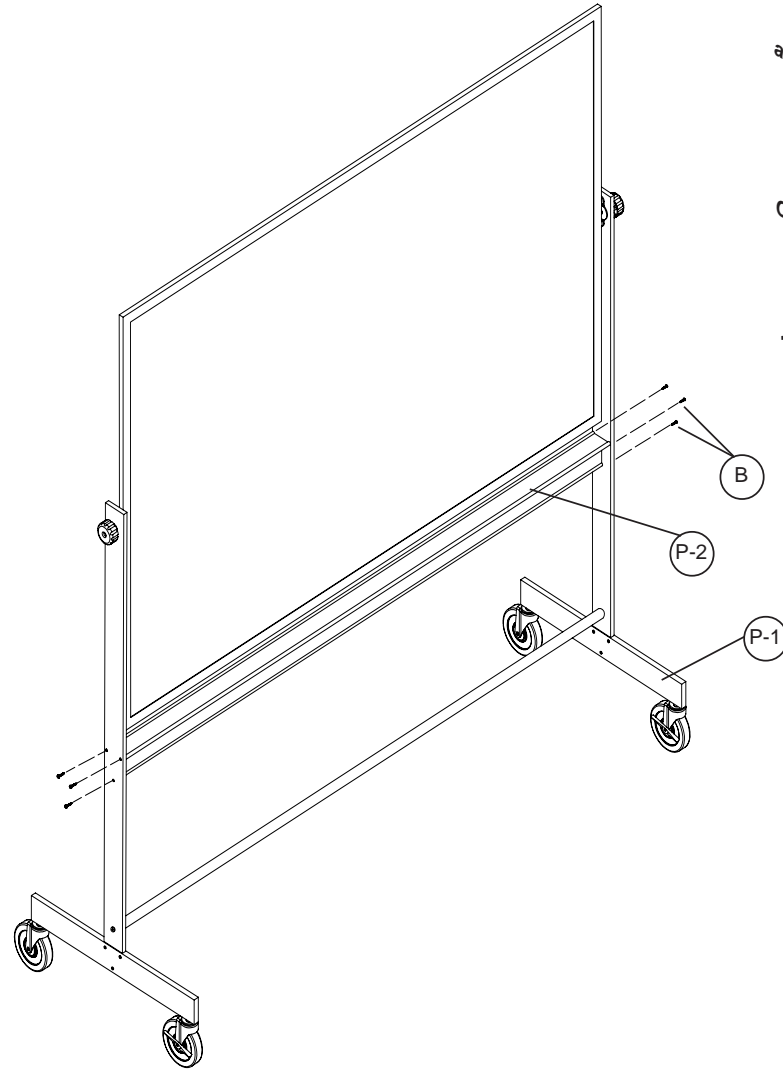

7 Tighten All Screws using a Phillips Screwdriver.

Should you require assistance during assembly, please call our Customer Service Department Monday - Friday 8 a.m. - 5 p.m. Central Standard Time

Toll-Free Customer Service
1-800-749-2258

Do not use unless all screws are tight. At least every six months, check all screws to be sure they are tight. If parts are missing, broken, damaged, or worn, stop use of the product until repairs are made by your dealer using factory authorized parts.