

***Best-Rite 4' x 8' Platinum  
Reversible 2-Sided Porcelain  
Whiteboard with Aluminum Frame***

Instruction Manual



*Provided by*

**MyBinding.com**

*When Image Matters.*

Call Us at 1-800-944-4573



Best-Rite™

# Platinum Reversible

669RU and 669RG

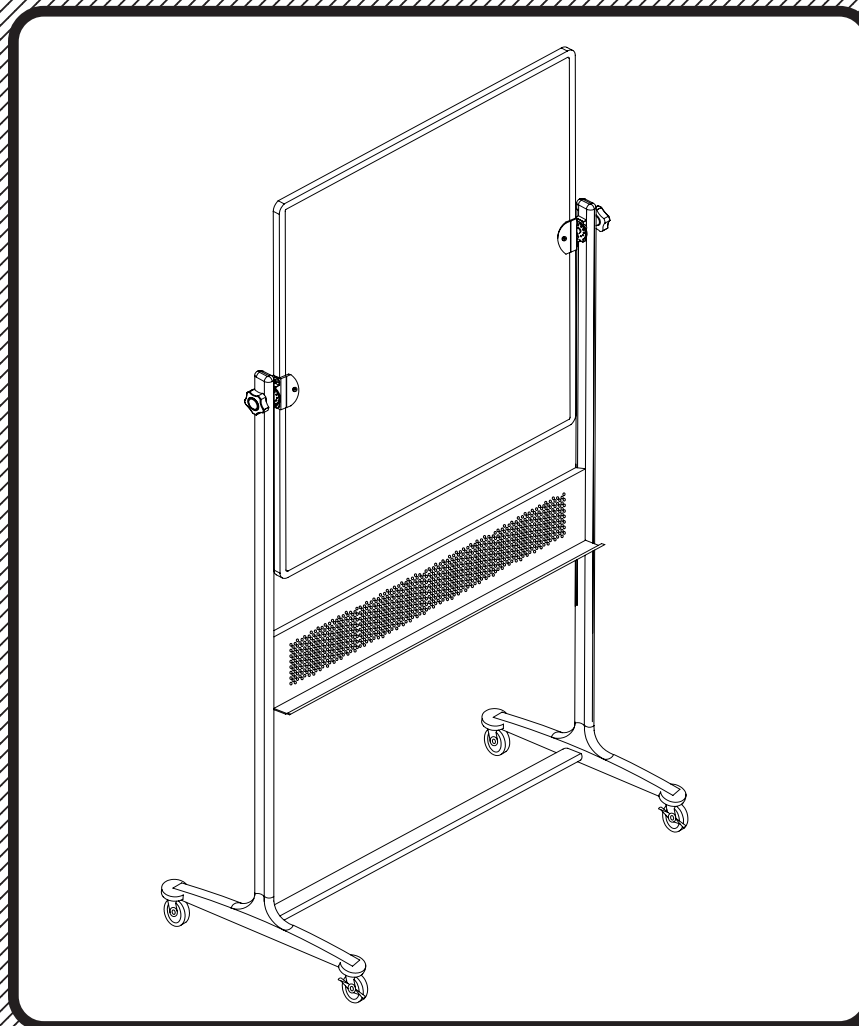





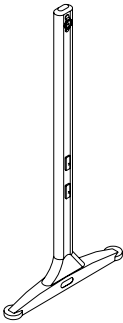
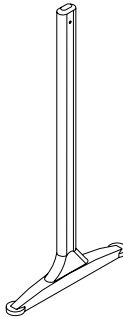
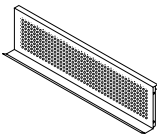
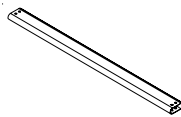
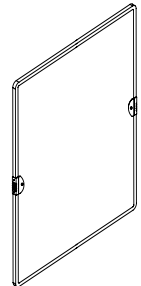



## Assembly Instructions

# Platinum Reversible

Part	Drawing	Description	Qty
P-1		Right Leg	1 EA
P-2		Left Leg	1 EA
P-3		Tray	1 EA
P-4		Cross Bar	1 EA
P-5		Framed Board	1 EA

### Hardware List

A		Long Socket Screw	4 EA
B		Short Socket Screw	4 EA
C		Flange	2 EA
D		Knob	2 EA
E		3" Locking Caster	4 EA
H		Allen Wrench	1 EA
I		Caster Wrench	1 EA
J		Lock Washer	4 EA

***Should you require assistance during assembly, please call our Customer Service Department Monday - Friday 8 a.m. - 5 p.m. Central Standard Time Toll-Free Customer Service 1-800-749-2258***

# Platinum Reversible Assembly Diagram

READ THROUGH INSTRUCTIONS FROM BEGINNING TO END **BEFORE** STARTING TO ASSEMBLE UNIT.

1. To Assemble:

Identify and Separate all the Parts and Hardware.

2. Install Cross bar (P-4) to the Legs (P-1) and (P-2) by using Long Socket Screws (A). Tighten with Allen Wrench (H). See illustration # 1.

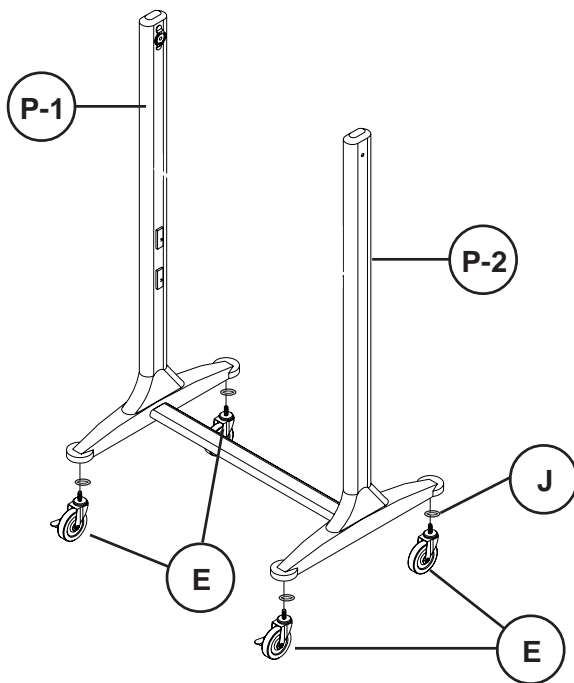
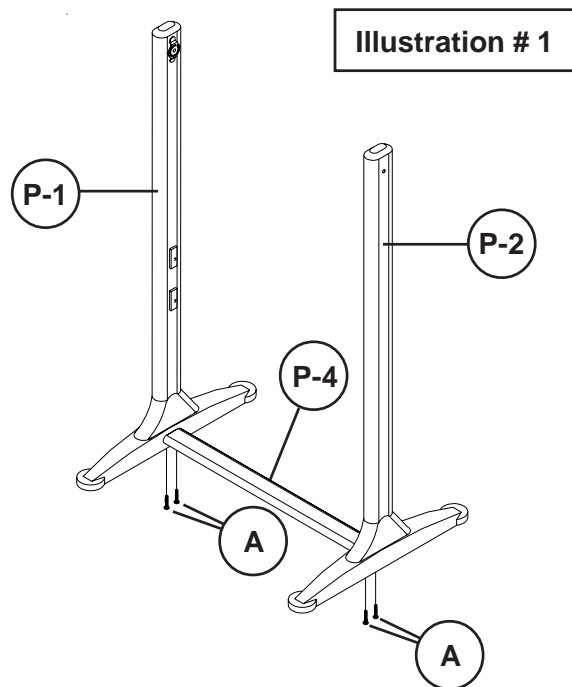

3. Place Lock Washer (J) on threaded stems of Locking Casters (E) and insert into the bottom of each Leg (P-1) and (P-2) and tighten using Caster Wrench (I). See illustration #2.

Illustration # 2

**Missing Parts or UPS Damaged Parts**  
For Your Convenience you can  
EMAIL us at  
**[boards@bestrite.com](mailto:boards@bestrite.com)**  
24HOURS 7 DAYS A WEEK

**Illustration # 3**

4. Detach 2 Screws from each side of Framed Board's brackets (P-5) with Allen Wrench (H) as shown in illustration # 3.

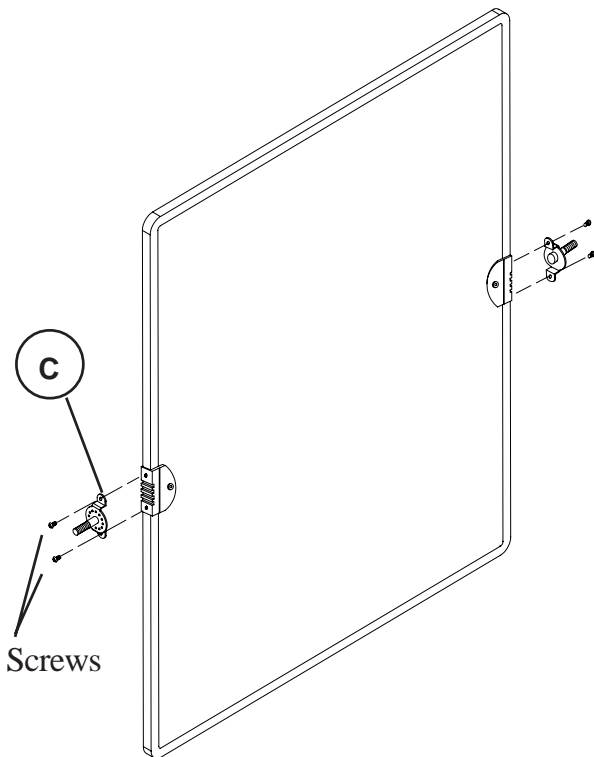
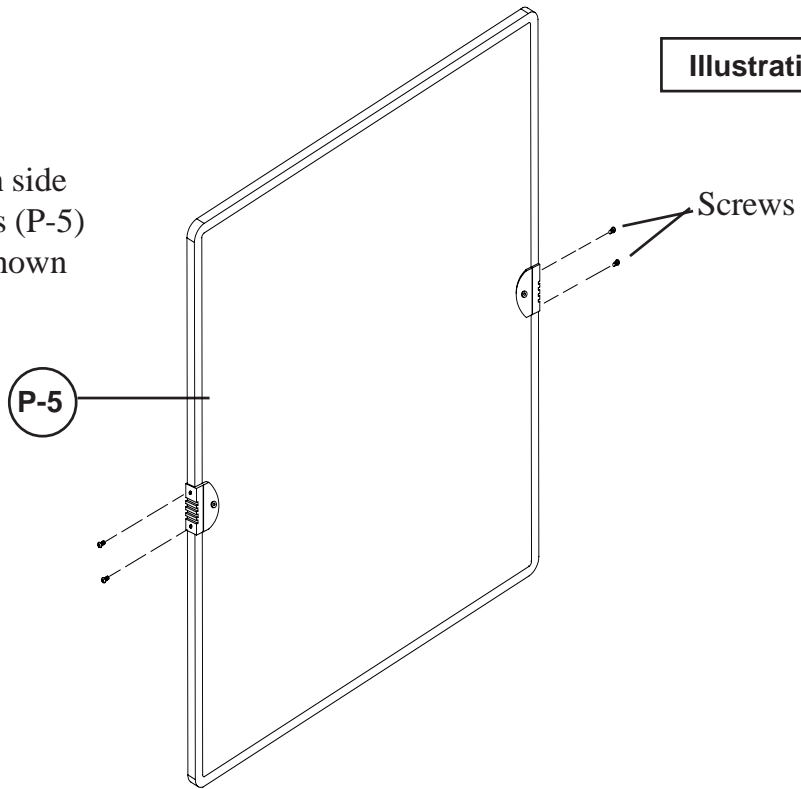

**Illustration # 4**

5. Install Flange (C) on each side of the board using the same Screws from Step 4 and tighten with Allen Wrench (H). See illustration # 4.

Do not use unless all screws are tight. At least every six months, check all screws to be sure they are tight. If parts are missing, broken, damaged, or worn, stop use of the product until repairs are made by your dealer using factory authorized parts.

# Platinum Reversible

6. Separate the Legs (P-1) and (P-2) slightly in order to insert the Flange (C) bolts on sides of Framed Board (P-5) through the flange hole on each legs. Fasten the Knobs (D) to secure the board in place. See illustration # 5.

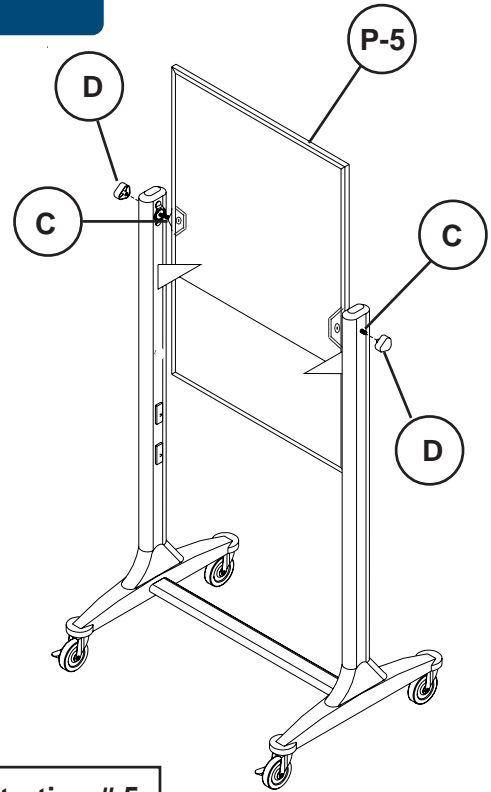

Illustration # 5

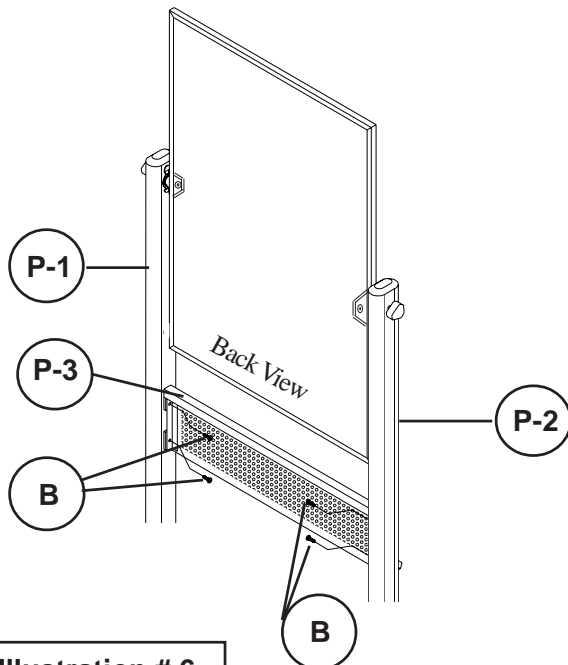
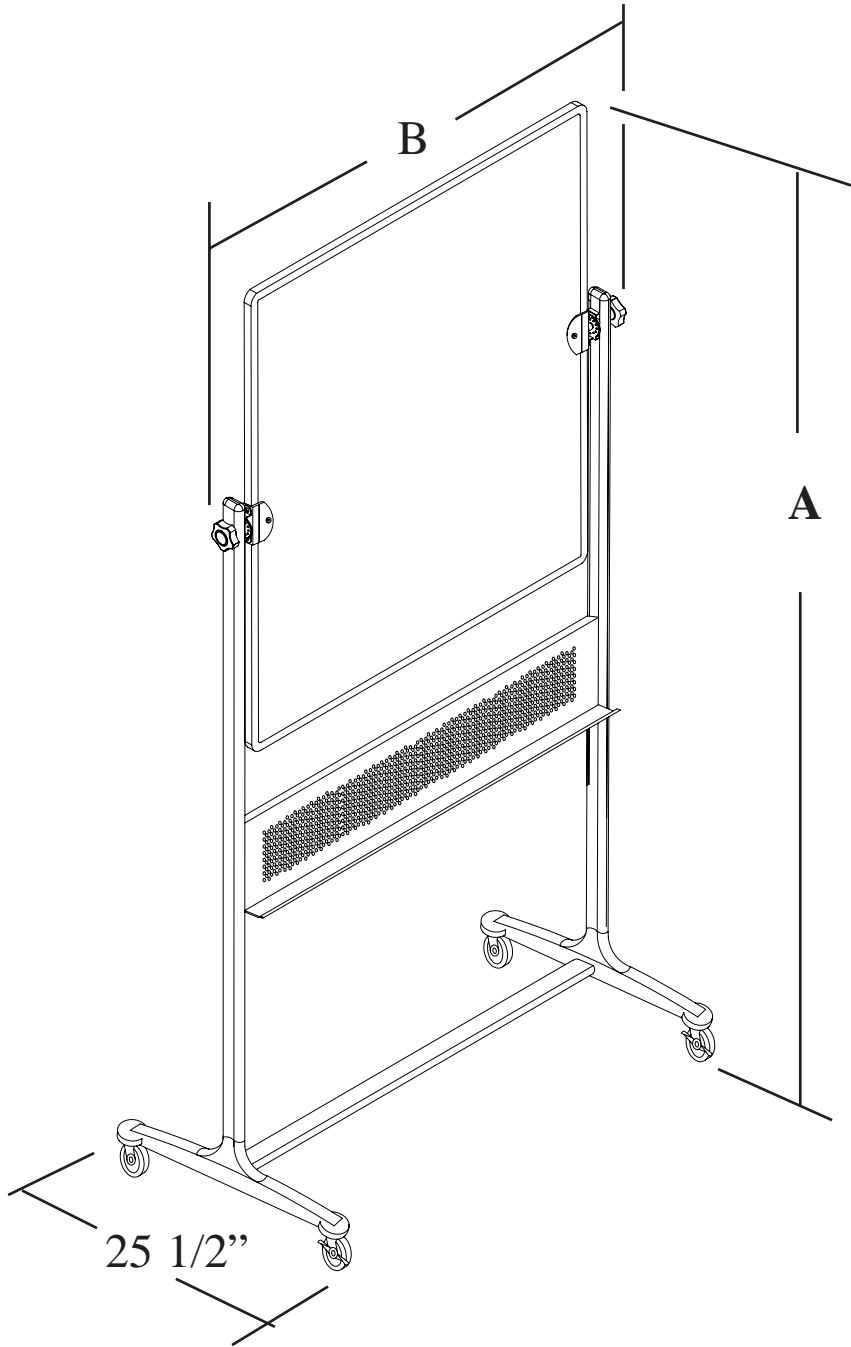

Illustration # 6

7. Assemble Tray (P-3) to the Legs (P-1) and (P-2) with using 4 Short Socket Screws (B) and tighten with Allen Wrench (H). See illustration # 6.



# Platinum Reversible 669RU and 669RG



	669RU	669RG
A	75"	79"
B	38 1/2"	80 1/2"