

# ***Best-Rite The Wheasel - 2 Sided Unframed Melamine Markerboard***

Instruction Manual



*Provided by*

**MyBinding.com**  
*When Image Matters.*

Call Us at 1-800-944-4573







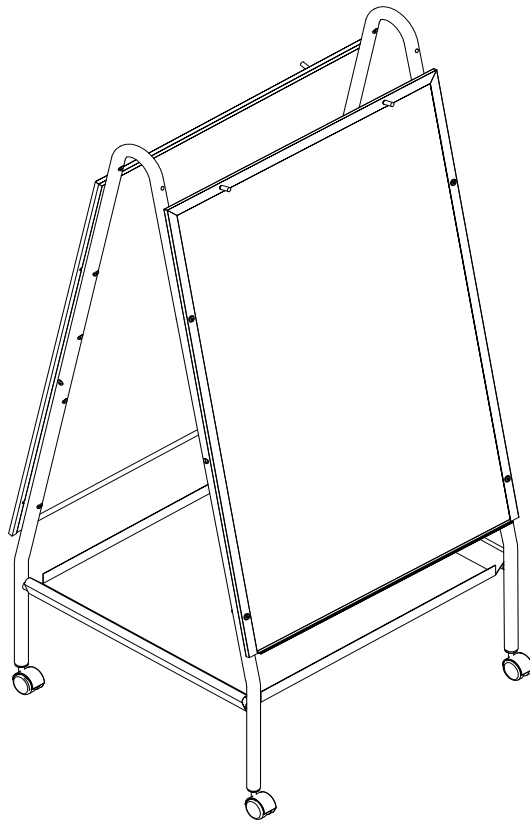





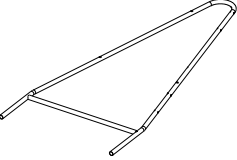

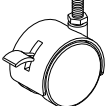



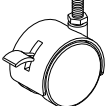

Best-Rite™

# #759M, 770 Wheasel

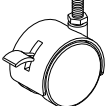

## Assembly Instructions

# #759M, 770 Wheasel

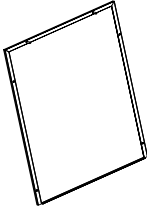
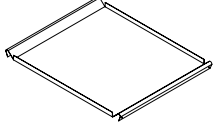
Part	Drawing	Description	Qty	Part	Drawing	Description	Qty																								
P-1		Welded Leg	2 EA	<div style="border: 1px solid black; border-radius: 15px; padding: 10px; text-align: center;"> <b>Hardware List</b> </div> <table style="width: 100%; border-collapse: collapse;"> <tr> <td style="text-align: center;">A</td> <td style="text-align: center;"></td> <td>Screw M6x18mm</td> <td style="text-align: right;">8 EA</td> </tr> <tr> <td style="text-align: center;">B</td> <td style="text-align: center;"></td> <td>Threaded Post</td> <td style="text-align: right;">8 EA</td> </tr> <tr> <td style="text-align: center;">C</td> <td style="text-align: center;"></td> <td>2" Locking Caster</td> <td style="text-align: right;">4 EA</td> </tr> <tr> <td style="text-align: center;">D</td> <td style="text-align: center;"></td> <td>Allen Wrench</td> <td style="text-align: right;">1 EA</td> </tr> <tr> <td style="text-align: center;">E</td> <td style="text-align: center;"></td> <td>Caster Wrench</td> <td style="text-align: right;">1 EA</td> </tr> <tr> <td style="text-align: center;">G</td> <td style="text-align: center;"></td> <td>Washer</td> <td style="text-align: right;">8 EA</td> </tr> </table>				A		Screw M6x18mm	8 EA	B		Threaded Post	8 EA	C		2" Locking Caster	4 EA	D		Allen Wrench	1 EA	E		Caster Wrench	1 EA	G		Washer	8 EA
A		Screw M6x18mm	8 EA																												
B		Threaded Post	8 EA																												
C		2" Locking Caster	4 EA																												
D		Allen Wrench	1 EA																												
E		Caster Wrench	1 EA																												
G		Washer	8 EA																												
P-2		Markerboard Panel	2 EA																												
P-3		Bottom Tray	1 EA																												
				<p><i>Should you require assistance during assembly, please call our Customer Service Department Monday - Friday 8 a.m. - 5 p.m. Central Standard Time</i></p> <p><b>Toll-Free Customer Service</b></p> <p><b>1-800-749-2258</b></p>																											
				<p><b>Missing Parts or UPS Damaged Parts</b>          For Your Convenience you can EMAIL us at  <b><u><a href="mailto:support@moorecoinc.com">support@moorecoinc.com</a></u></b>  <b>24HOURS 7 DAYS A WEEK</b></p>																											

**READ THROUGH INSTRUCTIONS FROM BEGINNING TO END BEFORE STARTING TO ASSEMBLE UNIT.**

To Assemble:

- 1.) Identify and Separate all the Parts and Hardware.
- 2.) Attach 4 Locking Casters (C) the Bottom of the 2 Legs (P-1). Tighten casters using Caster Wrench (E). See Illustration #1.
- 3.) Attach Markerboard Panel (P-2) to the 2 Legs (P-1) using 4 Screws (A), 4 Washers (G) and 4 Threaded Posts (B) as shown in Illustration # 2. Make sure to place the Washers (G) between the Marker Board and the Leg. Tighten all Screws using Allen Wrench (F).

**Illustration # 1**

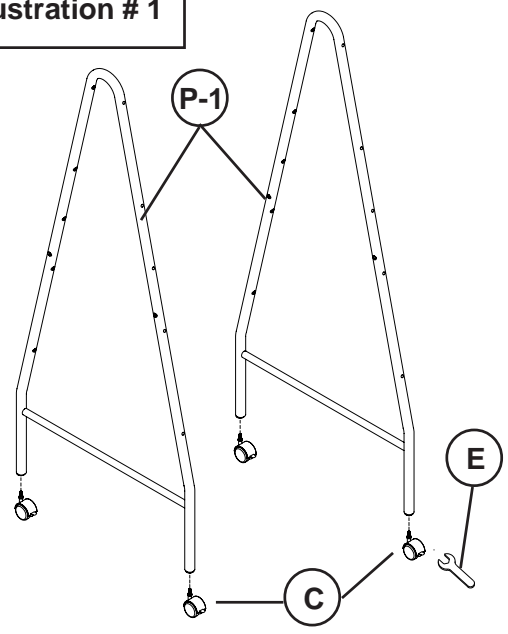

**Illustration # 2**

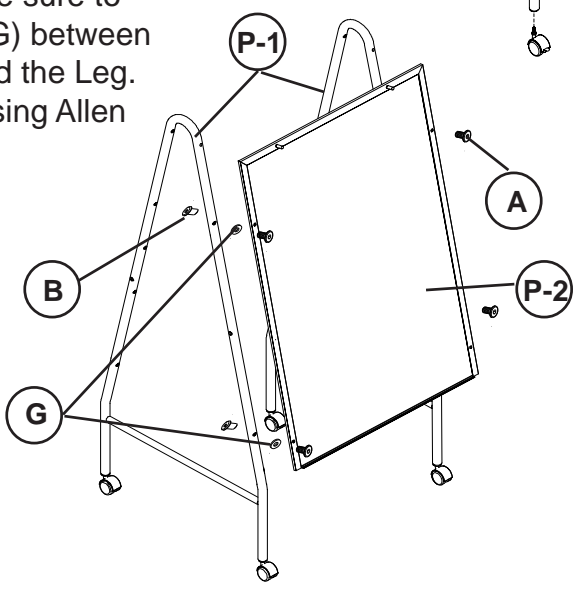

- 4.) Hook the Bottom Tray (P-3) over the two horizontal brace tubes on both Welded Legs (P-1) as shown in Illustration # 3.

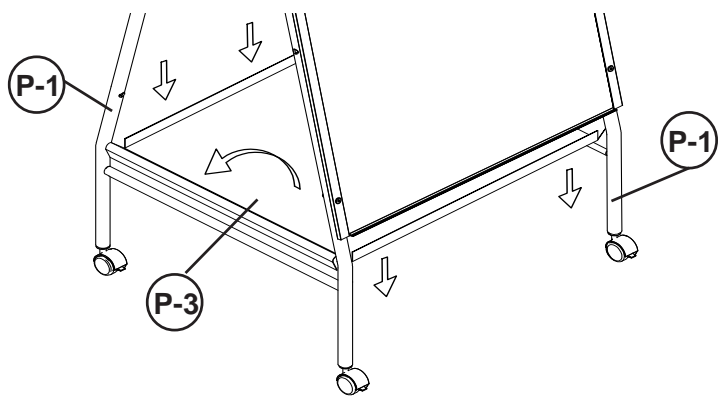

**Illustration # 3**

- 5.) Repeat Step 3 to attach the second Markerboard Panel (P-2) to the other side of the Welded Legs (P-1).