

Best-Rite 4' x 8' Black Splash- Cork Bulletin Board with Ultra Trim

Instruction Manual



Provided by

MyBinding.com
When Image Matters.

Call Us at 1-800-944-4573

1 Locate and Drill holes for Z-Hangers.

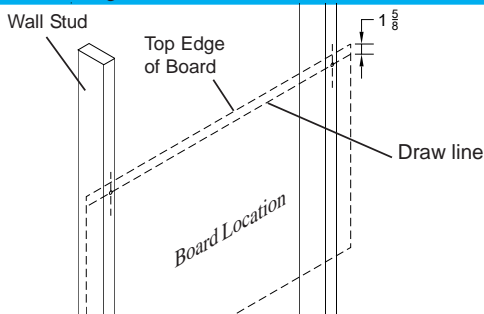

Determine board location. Measure from floor to the top edge of board. Mark with pencil line the corner location. Measure down from top edge of board 1-5/8", and draw line as shown. Locate stud near each end of board and drill pilot hole along line using 1/16" drill bit.

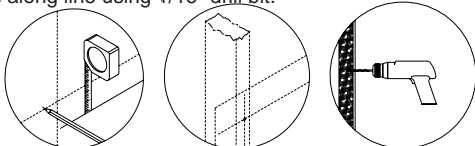

2 Attach Z-Hangers for mounting.

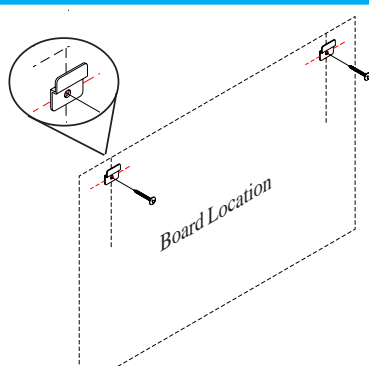

Attach 2 Z-Hangers using 2 Long Screws as shown

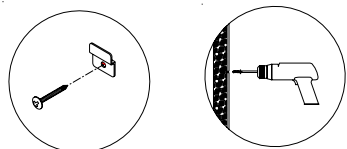

3 Hang board and mark bottom

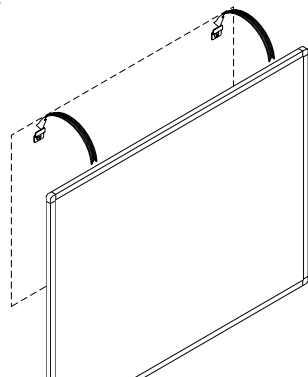

Hang board on the Z-Hangers using the Hanging brackets mounted on the back of the board. Draw line along bottom edge of board.

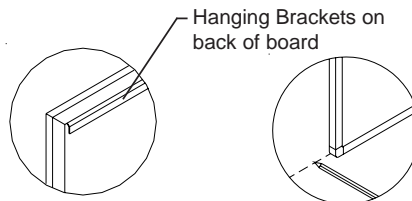

4 Remove board and drill

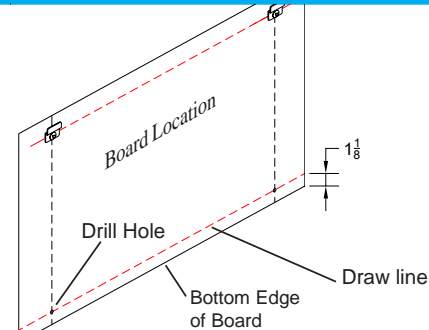

Lift and remove board from the Z-Hangers. Measure up from bottom line of board 1-1/8", and draw line as shown. Locate stud near each end of board and drill pilot hole along line using 1/16" drill bit.

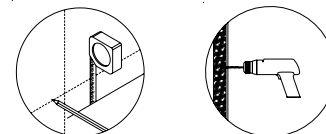

5 Attach Lower Brackets and Hang board

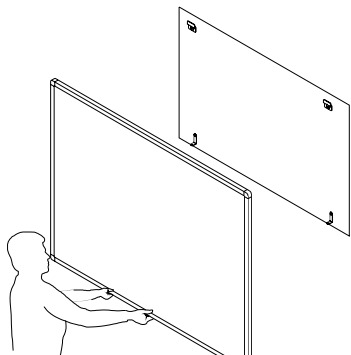

Secure 2 bottom brackets to the wall using 2 long screws as shown. Hang board on the Z-Hangers using the Hanging brackets mounted on the back of the board.

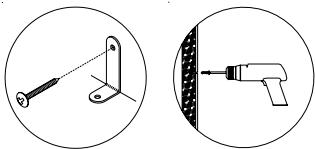

6 Secure Board

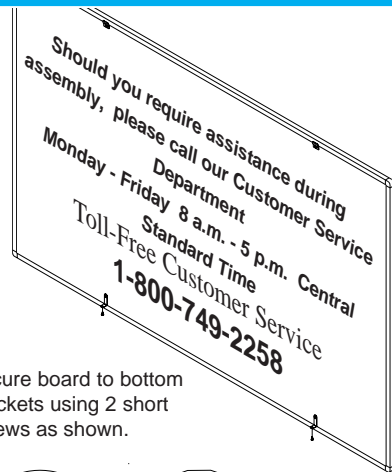

Secure board to bottom brackets using 2 short screws as shown.

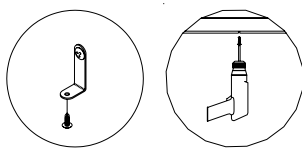

Parts List		
P1	Board	1 EA

Hardware List		
A	Z Hanging Bracket	2 EA
B	Bottom Bracket	2 EA
C	Long Screw	4 EA
D	Short Screw	2 EA
E	Screw Anchor-Concrete	4 EA
F	Screw Anchor-Drywall	4 EA



SPLASH CORK
E300Px-T1 Tackboard

