

1 Measure the distance between the large holes of the mounting brackets on the back of your board.

2 Locate and Drill holes for Screws or Anchors

3 Install the hanging screws as shown below for the type wall you have.

4 Hook the board's brackets on the Screw heads.

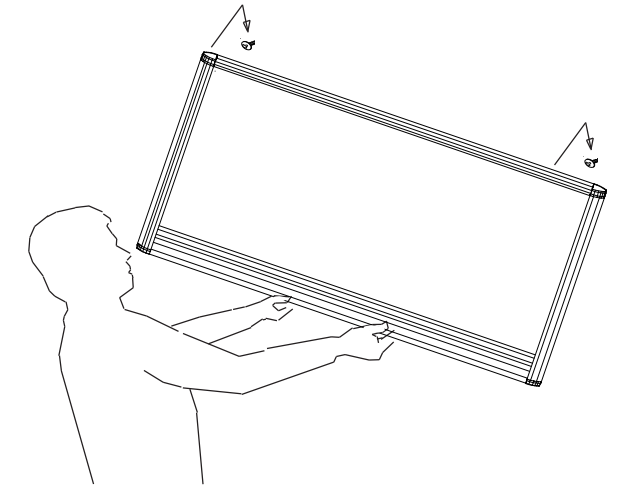
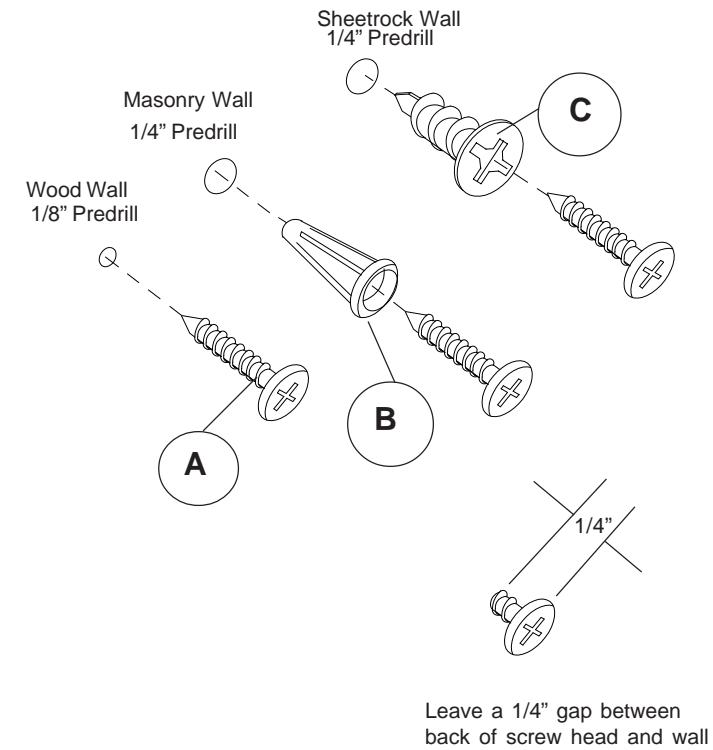
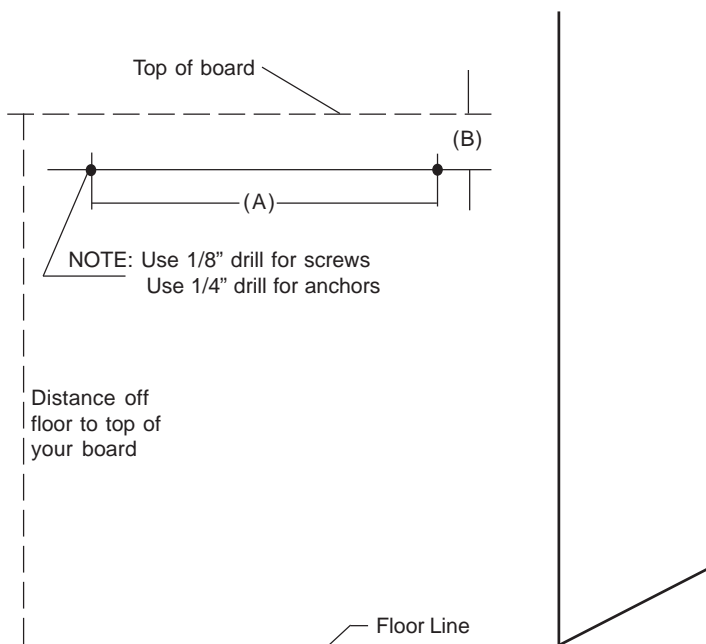
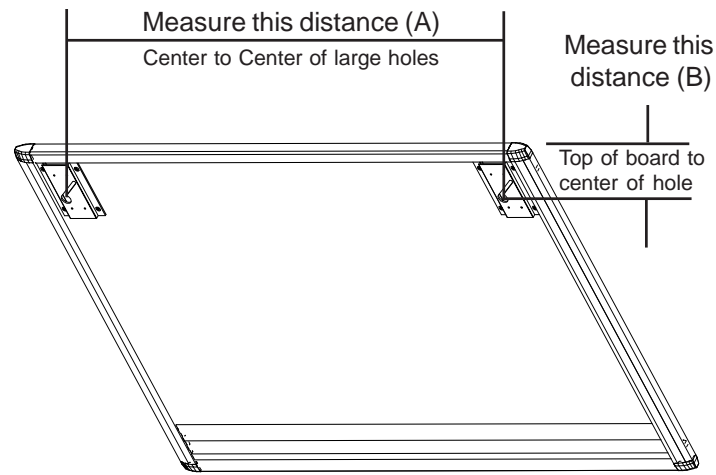

5 Peel off protective film from the front of the board before using.

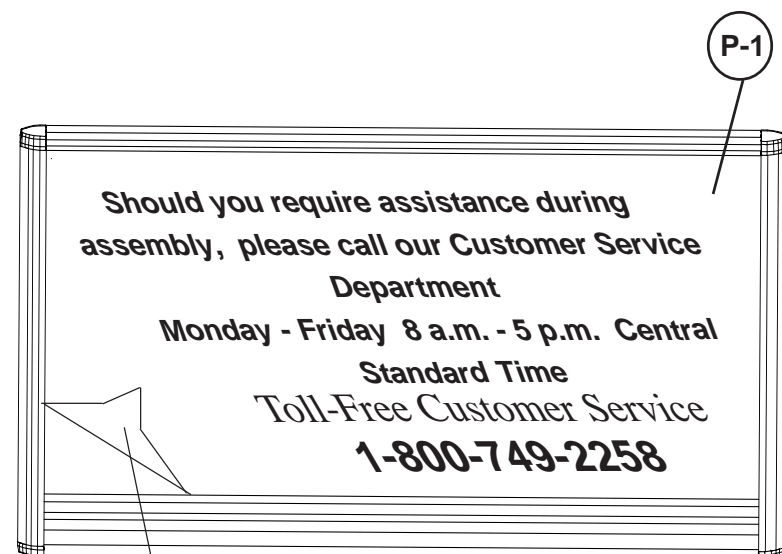

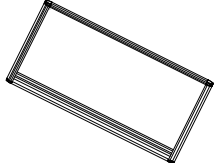

Peel off clear protective film.

Parts List

P1		Board	1 EA
----	---	-------	------

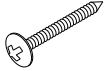
Hardware List

A		Long Screw	2 EA
B		Screw Anchor - Masonry	2 EA
C		Screw Anchor - Sheetrock	2 EA



661
Hang Up Board

