

# ***Challenge Spartan 185AEP 18.5' Electronic Programmable Cutter***

Instruction Manual



*Provided by*

**MyBinding.com**

*When Image Matters.*

Call Us at 1-800-944-4573

Serial Numbers 051001 & Up

# OPERATOR'S MANUAL



## ***SPARTAN 185 AEP*** ***FULLY-AUTOMATIC*** ***PROGRAMMABLE*** ***PAPER CUTTER***

*Sold and Serviced by*

**The Challenge Machinery Company**  
6125 Norton Center Drive  
Norton Shores, MI. 49441

[www.challengemachinery.com](http://www.challengemachinery.com)



# 1.0 Introduction

---

THIS MANUAL is designed to help you get the most from your Challenge equipment. Keep this manual in a safe, convenient place for quick reference by operators and service personnel.

## **CAUTION**

**SAFETY ALERT!** This symbol means **CAUTION: Personal safety instructions!** Pay special attention to the instructions in bold type. Personal injury may result if the precautions are not read and followed.

**READ THIS MANUAL BEFORE OPERATING!** Follow precautions and instructions. If after reading the manual questions still remain, contact your Authorized Challenge Dealer.

Take a few minutes right now to **RECORD YOUR MACHINE SERIAL NUMBER** in the space provided on the front cover of this manual. Also be sure to fill out the warranty card accompanying your machine and return it **DIRECTLY TO CHALLENGE**.

If you bought a used machine, it is important to have the following information on record at Challenge. Copy this page, fill in the information and send it care of The Challenge Service Department, 6125 Norton Center Drive, Norton Shores MI. 49441.

CHALLENGE MODEL	SERIAL NUMBER	
ATTN	COMPANY	
ADDRESS		
CITY	STATE/PROVINCE	ZIP
PHONE	DATE INSTALLED	
DEALER NAME & CITY		

### \* WARRANTY INFORMATION \*

It is very important that you read and understand the conditions outlined in the *Warranty Information Sheet* attached to the outside of the shipping container of your machine.

The *Warranty Information Sheet* must be filled out completely and returned to THE CHALLENGE MACHINERY COMPANY in order for the warranty to be issued for this machine.

## TABLE OF CONTENTS

1.0 Introduction.....	2
2.0 Safety .....	4
2.1 Precautions .....	4
2.2 Power Lockout Procedure.....	4
2.3 Warning Label Definitions .....	5
3.0 Packing List .....	7
4.0 Specifications .....	8
5.0 Installation & Setup .....	9
5.1 Inspecting Shipment.....	9
5.2 Uncrating.....	9
5.3 Cleaning .....	10
5.4 Power Hook-Up.....	10
6.0 Operation .....	11
6.1 Power – Main Switch.....	11
6.2 Power Clamp Breaker Switch .....	11
6.3 Start Up .....	12
6.4 Jogging Aid .....	12
6.5 Line Light.....	13
6.6 Making a Cut .....	13
6.7 Clamp Only Feature .....	14
6.8 Adjusting the Knife Depth .....	15
6.9 Cutting Tips .....	15
6.10 Manually Positioning the Backgauge .....	15
6.10.1 Backgauge Control Knob.....	15
6.10.2 Backlash Indicator .....	15
6.11 Electronically Positioning the Backgauge .....	16
6.11.1 Control Panel - Definition of Keys.....	16
6.11.2 Send Mode .....	17
6.12 Maintenance Mode.....	17
6.13 Job Mode .....	19
6.13.1 Creating a New Job .....	19
6.13.2 Editing an Existing Job .....	20
6.13.3 Running a Programmed Job.....	21
6.13.4 Exiting a Job .....	21
6.14 An Example Job.....	21
7.0 Knife Installation/Changing.....	23
7.1 Knife Removal.....	23
7.2 Knife Installation.....	24
7.3 Knife Care Tips .....	25
7.3.1 Knife Blade Life.....	25
7.3.2 Cutting Stick.....	26
7.3.3 Bevel Angle.....	26
7.3.4 Helpful Suggestions.....	26
7.3.5 Knife Care .....	26
8.0 Maintenance and Troubleshooting .....	28
8.1 Maintenance.....	28
8.2 Troubleshooting .....	28
9.0 Footprint .....	29
10.0 Safety Systems Test .....	30

## 2.0 Safety

---

### 2.1 Precautions

- This machine is designed for one-person operation. Never operate the machine with more than one person.
- Safe use of this machine is the responsibility of the operator. Use good judgment and common sense when working with and around this machine.
- Read and understand all instructions thoroughly before using the machine. If questions remain, contact the dealer from which you purchased this machine. Failure to understand the operating instructions may result in personal injury.
- Only trained and authorized people should operate this machine.
- **DO NOT ALTER SAFETY GUARDS OR DEVICES.** They are for your protection. Severe personal injury may result.
- **Disconnect power** before cleaning or performing maintenance. See Section 2.2 Power Lockout Procedure.
- Observe all caution labels on this machine.
- Be sure the cutter is properly grounded.
- Be sure there is sufficient power to operate the cutter properly.
- Observe all caution plates mounted on this cutter.
- Keep foreign objects off table and away from cutter blade.
- **BE EXTREMELY CAREFUL** when handling and changing the cutter knife. Severe lacerations or dismemberment could result from careless handling procedures.
- Keep the floor around the cutter free of trim, debris, oil and grease.
- When replacing hydraulic parts, loosen the connections slowly to release pressure. Never loosen connections with the machine running.
- If the cutter sounds or operates unusually, have it checked by a qualified service person.
- **CRUSH HAZARD**, keep hand and fingers from under the clamp when clamping paper. Use Jogging Aid to load paper, and use the backgauge to push paper out before unloading. **DO NOT REACH UNDER THE KNIFE AND CLAMP AREA!**

### 2.2 Power Lockout Procedure

For maximum safety while making adjustments or repairs to your machine, be sure to disconnect power to the machine. Disconnect the power plug from its socket

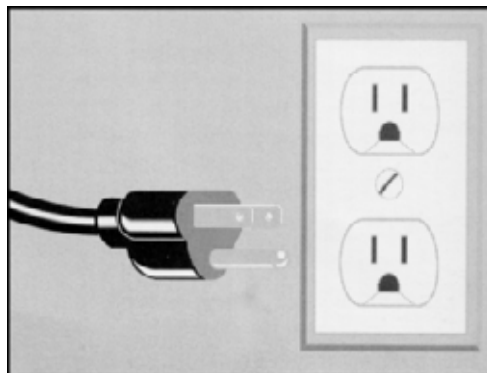

Figure 1 - Main Power Disconnect

## 2.3 Warning Label Definitions

The following warning labels are found at various locations on your machine. Read and understand the meaning of each symbol. If a label is lost from the machine, it should be replaced.



### HAZARDOUS AREA

Disconnect power before cleaning, servicing, or making adjustments not requiring power. Do not alter safety guards or devices; they are for your protection. Replace all guards. Do not operate with any guards removed.



### SHOCK HAZARD

Disconnect power before removing cover. Replace cover before operation.



### SHOCK HAZARD

Disconnect power before removing cover. Replace cover before operation.



### SINGLE OPERATOR

Do not operate with more than one person.

# !OJO!



**CAUTION** This Este simbolo de alerta de seguridad significa ¡ OJO ! - INSTRUCCIONES DE SEGURIDAD PERSONAL. Lea las instrucciones porque se refieren a su seguridad personal. Fall de obedecer las instrucciones que siguen podria resultar en lesiones corporales.

- Esta maquina, junto con sus mecanismos de seguridad, esta disenada para ser manejada por
- **UNA SOLA PERSONA** a la vez. Jamas debe ser manejada por mas de una persona al mismo tiempo.
- La seguridad es la responsabilidad del operario que usa esta maquina.
- **LEA DETENIDAMENTE** el manual de instrucciones y las **PRECAUCIONES DE SEGURIDAD** antes de poner a funcionar la cortadora. Pidale a su supervisor una copia.
- El manejo de la guillotina debe estar exclusivamente a cargo de personal entrenado y autorizado para ello.
- **NO MODIFIQUE LOS MECANISMOS DE SEGURIDAD**, estan ahi para su proteccion no deben ni modificarse ni quitarse.
- **DESCONECTE LA CORRIENTE ELECTRICA** antes de proceder a hacerle servicio de limpieza, engrasar, o de hacer ajustes que no requieren corriente. Trabe el interruptor en la posicion **OFF** (apagado); vea "Procedimiento para cortar la corriente electrica" al pie de esta pagina.
- Eche llave a la guillotina y quite la llave cuando la maquina no esta en operacion; vea "Corriente electrica".
- Asegurese de que la guillotina este debidamente a tierra. Vea "Conexion de la fuerza electrica".
- Verifique el voltaje y asegurese de que este sea suficiente para el debido funcionamiento de la guillotina.
- Preste atencion a todas las placas con advertencias instaladas en esta guillotina.
- No permita que objetos estranos esten en la mesa o cerca de la cuchilla cortadora.
- **TENGA SUMO CUIDADO** al tocar y cambiar la cuchilla. Heridas severas y hasta desmembramiento pueden resultar del manejo sin cuidado o negligente.
- El suelo alrededor de la guillotina debe mantenerse despejado y libre de recortes, desperdicios, aceite y grasa.
- Al haber la necesidad de reemplazar partes hidraulicas, afloje todas las conexiones poco a poco para dejar escapar la presion. Jamas debe aflojarse conexiones mientras la maquina este andando.
- Si la guillotina empezara a sonar o trabajar diferentemente a lo acostumbrado, desconectela y consulte la seccion "Troubleshooting" (Reparador) de este manual. Si no es posible corregir el problema, llame a su servicio autorizado para que le examinen la maquina.
- **PELIGRO DE MACHUQUE** - Mantenga manos y dedos fuera de la agarradera mientras sujeta el papel. Use el calibrador trasero y su rueda de mano para empujar el papel cortado. **NO PONGA SUS MANOS BAJOLA CUCHILLA O AREA DE LA AGARRADERA.**
- **NO OPERE SIN LAS GUARDAS PROTECTORAS!**

## ¡ OJO ! PRECAUCION - Como proceder para desconectar la corriente electrica.

Para maxima seguridad durante ajustes y reparaciones de su maquina, verifique bien que el interruptor principal de control de corriente al cual la maquina esta conectada, este desconectado. El interruptor deba ser puesto en la posicion "OFF" (desconectado) y se debe poner un candado en la anilla. La llave del candado debe ser guardada por la persona que estara efectuando los trabajos de servicio o de reparacion en la guillotina.

Desconecte la corriente electrica antes de proceder a hacer cualquier ajuste o reparacion o de efectuar el engrase en cualquier maquina.

## 3.0 Packing List



Part No.	Description	Qty.
Spartan 185 AEP	18-1/2" Fully-Automatic, Prog. Paper Cutter	1
F.185AEP-O	Operator Manual	1
63073	Knife Lifter Assembly	1
63017	Knife – Standard (installed in machine)	1
63015	Cutting Stick (installed in machine)	1
A-12608-2	Jogging Aid	1
W-191	3/16" Hex 'T' Allen Wrench	1
5064	Cutting Stick Puller	1
	Knife Scabbard	1
	Machine Lifter Handles	4

## Optional Items

Part No.	Description	Qty.
63015	Extra Cutting Sticks	1
63017	Knife – Standard	1
63017-1	Knife – Long Lasting H.S.S.	1



## 4.0 Specifications

Description	Inch Units	Metric Units
Cutting Width	18-1/2"	47 cm
Minimum Cut	1"	2.5 cm
Clamp Opening	3"	7.6 cm
Table Space		
Front:	13"	33 cm
Back:	17-1/2"	44.5 cm
<b>Dimensions</b>		
Overall Height	52-3/4"	134 cm
Table Height	36"	91.4 cm
Overall Length	41"	104 cm
Overall Width	32-1/4"	82 cm
Approx. Net Weight	570 lbs	260 kg
Approx. Shipping Weight	700 lbs	318 kg
<b>Electrical</b>		
120 Volts 60 HZ. 16 Amps, Service Size 20 Amps Receptacle NEMA 5-20R		

Challenge reserves the right to make changes to any product or specification without notice and without incurring responsibility to existing units.

## 5.0 Installation & Setup

### 5.1 Inspecting Shipment

This machine has been carefully packed to prevent damage during shipment. However, claims for damage or loss are the responsibility of the recipient. Inspect all shipments as soon as they are received. If there is any noticeable damage, note it on the freight bill. Visual and/or hidden damage must be reported to the claims department of the carrier within 15 days. Contact your dealer if you need any assistance. Check the contents of the box against the packing list on page 7. Make sure there are no missing items.

### 5.2 Uncrating

The Spartan 185 AEP weighs approximately 600 lbs (272 kg). DO NOT risk personal injury or damage by attempting to move machinery with makeshift equipment or inadequate help. This machine is shipped on a wooden skid and enclosed in a protective, wooden frame and corrugated carton. Remove the carton by removing the nails or staples holding it to the wooden frame and lift it straight up over the cutter.



Figure 2

Remove all tape and plastic wrapping. Remove the (4) lag screws from the base of the machine and (4) lag screws from the support blocks. Insert lifting handles. While lifting one side of the machine at a time, remove the support blocks and set aside. Unscrew ramp from skid, and position as shown in Figure 3. Secure ramp to skid using (2) nails where indicated by red circles on ramp.



Figure 3

## 5.0 Installation & Setup

---

Clear area in front of ramp. Using two or more persons, carefully roll machine off skid using lifting handles as shown in Figure 4.



Figure 4

Remove lifting handles and roll machine into position. Lock casters to prevent machine from inadvertently rolling.

### 5.3 Cleaning

After unpacking, wipe down all machine panels and surfaces with a clean cloth.

### 5.4 Power Hook-Up

**⚠ CAUTION** **SHOCK HAZARD! NEVER CUT THE GROUND TERMINAL** from a three-prong plug to fit a two-prong socket. Possible shock could cause personal injury or death. Have a qualified electrician to provide a power source that meets electrical requirements and all local electrical codes.

It is the customer's responsibility to provide a properly grounded receptacle that meets the power requirements specified on the nameplate of this machine, as well as all local electrical codes. Have a qualified electrician install one if your location is not so equipped. The socket-outlet shall be installed near the machine's location and be easily accessible.

Connect the power cord into a grounded, 3-prong receptacle only! 120 Volts 60 HZ. 16 Amps, Service Size 20 Amps Receptacle NEMA 5-20R



Figure 5

## 6.0 Operation

### **! CAUTION**

**IMPORTANT: DO NOT ATTEMPT TO OPERATE THE CUTTER UNTIL YOU HAVE THOROUGHLY READ AND UNDERSTAND ALL OF THE FOLLOWING INSTRUCTIONS. CALL YOUR AUTHORIZED CHALLENGE DEALER IF YOU STILL HAVE ANY QUESTIONS.**

### 6.1 Power – Main Switch

Power is enabled when the main power switch is turned to the “ON” position (Figure 6). The display and line light are turned on at this time.



Figure 6 –Power On-Off Switch and Circuit Breaker

### **! CAUTION**

If the knife is not at the “up” position when the main power switch is turned on, the knife will automatically move to the “up” position.

NOTE: The main power switch is also a circuit breaker and will automatically switch off in the event of too much current running through the switch, such as from an electrical short. To reset the circuit breaker, simply push the switch to the “on” position.

### 6.2 Power Clamp Breaker Switch

The machine will not operate if the Power Clamp Breaker Switch is tripped. If the switch is tripped, reset the switch by locating the switch on the bottom side of the machine and pressing in the button (Figure 7).

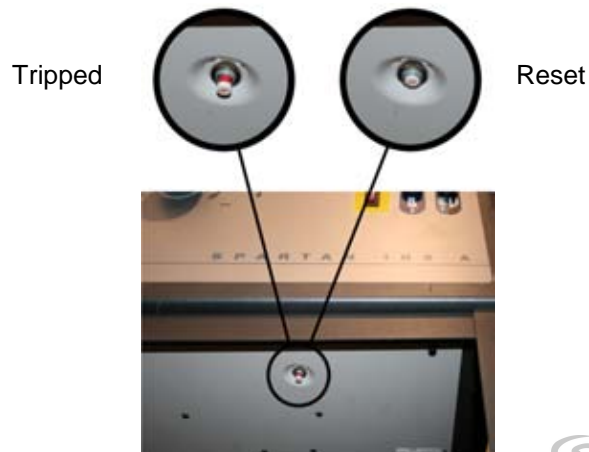
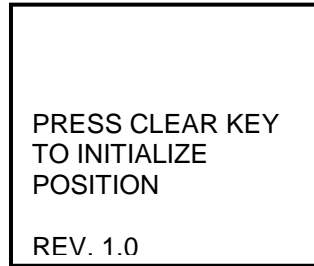

Figure 7 – Power Clamp Breaker Switch

### 6.3 Start Up

Once power has been turned on, the display will show the following:



When the CLEAR key is pressed the backgage will move to coordinate the true position into the computer. When the backgage is behind the preset the position will be counting down from approximately 17.00 inches until the preset is achieved at approximately 5 inches. If the backgage is in front of the presets the display will count up from 1 inch.

After preset the display will be as shown below:

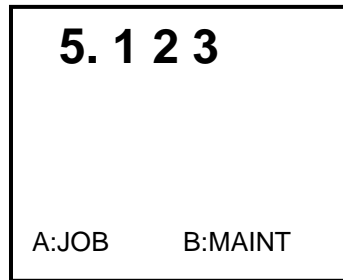

The backgage may now be sent to a desired position by simply typing the dimension and pressing SEND (see the Send Mode section, page 17, for more details).

### 6.4 Jogging Aid

**⚠ CAUTION** Always remove the jogging aid from the table before making a cut.

A jogging aid is included as standard equipment with the Spartan 185 AEP. This tool allows the operator to load and align paper without the need to place hands or arms under the knife or clamp.

To use, load the paper against the side and backgage using the jogging aid (Figure 8). Remove the jogging aid from the table, close the shield, clamp the paper, and make the cut.



**Figure 8 – Jogging Aid**

## 6.5 Line Light

The Spartan 185 AEP comes standard with an LED line light. The line light comes on and stays on whenever the power is on. To use, simply align paper under clamp, and use the red light line as an indicator of where the cut will be made.

## 6.6 Making a Cut

Open the front shield and set the backgauge to the desired position. Place the paper square against the backgauge and either side guide. Now close the front shield then press and hold both cut buttons which are indicated in Figure 9:

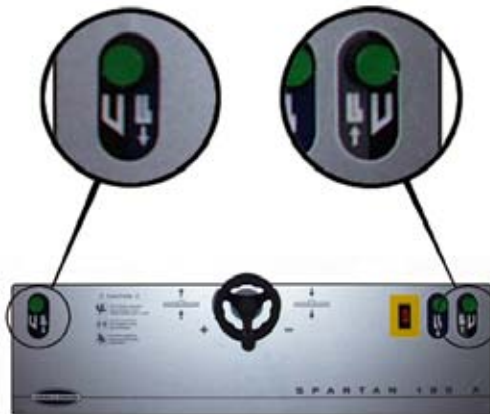

**Figure 9 – Cut Buttons**

Hold the buttons in until the clamp and knife stop moving. Now release the cut buttons and the knife and clamp will return to the “up” position and the front shield will automatically open. Note: releasing the cut buttons or raising the shield at any time during the cut cycle will immediately send the knife and clamp to the “up” position.

**Note:** The front shield must be opened and closed each time a new cut is to be made.

See Section 6.9 Cutting Tips, page 15 for more information about clamping and cutting.

## 6.7 Clamp Only Feature

The Spartan 185 AEP is equipped with a “clamp only” feature which allows the user to send the clamp down to the paper without cutting. This can be useful to double check the clamping location without making a cut. To use this feature, open the front shield and set the backgauge to the desired position. Place the paper square against the backgauge and either side guide. Now close the front shield then press and hold both clamp-only down buttons which are indicated in Figure 10 below:



**Figure 10 – Clamp Only Buttons**

A cut can now be made with the paper already clamped, or the clamp can be released without making a cut. To make a cut, press and hold both cut buttons as described in section 6.6 . To release the clamp without cutting, press and release the clamp up button which is indicated in Figure 11:



**Figure 11 – Clamp Up Button**

## 6.8 Adjusting the Knife Depth

The depth of cut can be adjusted using the knife depth adjusting screw located on the right side of the machine. The same T-handled wrench used for changing the knife can be used to adjust the screw. Turn the screw clockwise to increase knife depth, and counterclockwise to decrease knife depth. It is better to make several slight adjustments and perform test cuts in between, than to make large adjustments and cut too deep. Try to avoid setting the knife too deep as this can cause premature wear on knife and/or damage the cut stick.



Figure 12 – Knife Depth Adjustment

## 6.9 Cutting Tips

- For best results, it is a **MUST** to have a sharp blade in the cutter. A dull blade will pull or draw the paper and cause uneven cutting.
- Carefully lay out each sheet before cutting. Find the best cut pattern that gives the most pieces out of the sheet. If the sheet will be folded, be sure the grain of the paper is running in the same direction as the fold to avoid getting a rough edge on the fold.
- Mark the gripper edge and the guide edge of printed paper and make sure the first cuts are with these guide edges against the backgauge.
- When cutting business cards or narrow strips of paper, place lifts of equal height on opposite sides of the table to provide better clamping.

## 6.10 Manually Positioning the Backgauge

### 6.10.1 Backgauge Control Knob

The backgauge can be moved manually by use of the backgauge control knob. Turn the knob clockwise for forward travel and counter clockwise for reverse travel.

### 6.10.2 Backlash Indicator

To insure accurate cuts, the backgauge must be brought to the cut position from the rear of the table. The position display will be white on blue to indicate reverse travel. The position should be displayed as white numbers on blue background when making a cut. Moving back past your cut position, then forward to it, compensates for any play in the backgauge nut and leadscrew.



### 6.11 Electronically Positioning the Backgauge

#### 6.11.1 Control Panel - Definition of Keys

##### **IN/MM Key**

This key toggles the display to show the position and programmed send values in inches (e.g. 5.250), or millimeters (e.g. 133.3).

##### **Send Key**

The SEND key is used to send the backgauge to any valid position. If an attempt is made to send the backgauge to an illegal position, an error message will be displayed at the bottom of the screen stating "EXCEED LIMIT". In the Job mode, the SEND key will also advance the backgauge to the next sequential cut position before performing the cut.

##### **Push-Out Key/Hold-To-Run Backgauge Key**

This key has 2 functions. It is used to move the backgauge forward 5 inches (or to the most forward position) and then return it to its previous position. This allows paper to be removed from the cutter without putting hands under the knife and clamp. It also allows backgauge to move forward under program control for dimensions less than 2 inches (50.8mm).



Never place hands in the clamp and knife area. Use the push-out key or the backgauge control knob to move the paper to an area where it can be reached.

##### **Clear Key**

The CLEAR key is used to clear error messages and the current entry line.

##### **Enter Key**

The ENTER key selects items in the maintenance mode and processes data that has been entered in the other modes.

##### **Soft-Keys**

The soft-keys are labeled as A, and B. The definition for these keys change depending on the operating mode. The function of the key can be found on the bottom of the display screen.

##### **Arrow Keys**

The four arrow keys can be used in almost all screens. The arrow keys are primarily used for moving the cursor around on the screen, or to toggle between highlighted selections. In some screens, the left arrow key acts as a backspace key.

##### **Contrast Control**

The contrast of the display can be adjusted by pressing the up arrow or down arrow key in the send mode.

##### **Math Keys**

The +, -, X, / keys are used for math functions.

### 6.11.2 Send Mode

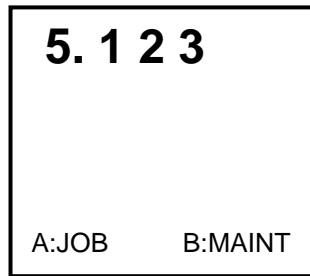

The send mode is the first screen displayed after the backgauge is preset. From this screen the backgauge can be positioned with the control knob or by entering a value and pressing the SEND key. If the send value is less than 2", the pushout button must be held in, for the backgauge to continue to the send position. A mathematical expression can also be entered as a send value. Simply type the expression and press SEND. You can also enter an equation, which begins with the current backgauge position. For example, if you want to send the backgauge 2" forward from its current position, just press [-] [2] and SEND.

The send mode screen can also be used for doing math calculations that are larger than the backgauge's reverse limit. In this case, you must press ENTER to have the result displayed on the screen.

In the simple send mode, the Spartan185 is capable of calculating a math string with 2 functions. An example is  $2+3/4$ . the result is limited to 65.000in or 1650mm and the result cannot be a negative value. In the job mode, and during a send, the result of the calculation must be less than the backgauge limit of 17.750 inches.

### 6.12 Maintenance Mode

The maintenance mode is an area where the machine accuracy, control knob centering and memory clear functions can be performed. From the Send Screen, "B" to go to the Maintenance Screen. To select a particular function, use the up and down arrow keys to toggle to the desired function and press ENTER. See the following descriptions for an explanation of each function.



## 6.0 Operation

---

### 6.12.1.1 Accuracy Adjust

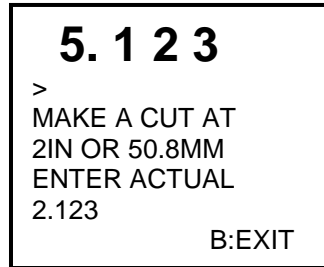

This parameter provides a means for adjusting the accuracy of the backgauge. To change the accuracy, send the backgauge to 2 inches (50.8mm) and cut some paper. Measure the paper, and type in what you actually measure. The computer will calculate the amount of error and will compensate. The accuracy adjust value is displayed in the lower left hand corner of the display.

### 6.12.1.2 Center Knob

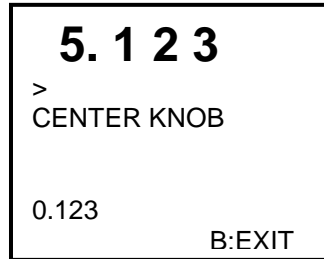

This function displays an reference value in the lower left corner of the display. By twisting the rubber connector between the hand knob and the potentiometer this value should be as close to 0 as possible.

### 6.12.1.3 Clear Memory

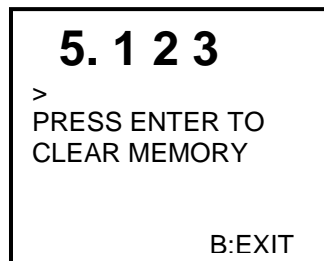

The Clear Memory function resets the memory to a known state. **All cut positions will be erased during this operation.**

## 6.13 Job Mode

The Spartan 185 AEP can be programmed for up to 20 different jobs or channels. A job is used for making a sequence of cuts using the send (or cut) values of the job as the backgauge positions for each cut. Each job can hold up to 25 send values. When the job mode is entered, all previously programmed jobs will be displayed along with their name. An example of a job mode screen display is shown below. Job 1 is always 10-BNSCARD. This job is used to cut 10 business cards form 8.5X11 stock.

```

SELECT JOB 1-20
>
  1> 10-BNSCARD
  2> TESTJOB
  5>
  6> BOBS JOB
  7> 8.5 X 11
                                B: Exit

```

### 6.13.1 Creating a New Job

To create a new job, type in a number that is not already assigned to a job and press ENTER. The cursor will move to the line corresponding to the number you typed in, prompting you for a job name. If no job name is desired, simply press ENTER again to begin entering send values (see below). To name the job, press the right arrow key to move the cursor to the first character position. Enter a character of the alphabet by using the up and down arrow keys to toggle to the desired character. The numeric keys can be used to enter numbers directly into the job name. When the desired character is in place, use the right arrow key to move to the next character position. The job name can be up to 10 characters long. A letter can be removed from the job name by moving the cursor to the undesired character and pressing the CLEAR key. When finished, press ENTER to save the name and to begin entering send values. The screen should now look similar to the one shown next:

```

SELECT JOB 1-20
>
  1> 10-BNSCARD
  2> TESTJOB
  5>
  6> BOBS JOB
  7> 8.5 X 11
                                B: Exit

```

#### 6.13.1.1 Entering Send Values

```

  5.123          5
SEND TO RUN JOB
  1>

A:EDIT          B: EXIT

```

## 6.0 Operation

---

Now enter send values by using any of the following methods: 1) Type in the desired value and press ENTER, 2) Press ENTER at a blank line - this will enter the current position of the backgauge as a send value. The first valued entered in a job will take 5 to 10 seconds.

When finished entering send values you may exit the current job by pressing soft-key "B" (EXIT to go back to send mode. Or you may use the current job for cutting by pressing SEND.

### 6.13.2 Editing an Existing Job

#### 6.13.2.1 Editing the Job Name

The job name can be edited (or added if an existing job does not have a name) in the job mode screen. To edit the name, move the cursor down to the desired job number by pressing the down arrow key. Then press the right arrow key to move the cursor to the desired character position and edit the character by pressing the up or down arrow keys to toggle between characters of the alphabet. Numbers can be entered directly by using the number keys. Pressing CLEAR clears the current character. When finished, you may either go to the current job by pressing ENTER, or go to a different job, or exit job mode.

#### 6.13.2.2 Editing Send Values

To edit send values of an existing job, start by opening the desired job from the job mode screen. A job is opened by one of two methods: pointing at the desired job with the cursor and pressing ENTER, or by entering the job number with the keypad and pressing ENTER. Once a job has been opened, the current job number will be displayed in the upper right corner.

Send values can now be edited by moving the cursor up or down to the desired send value and then typing over the existing value.

When finished editing the job, you may exit the current job by pressing soft-key "B" (Exit) to exit to send mode. Or you may use the job for cutting since it is already open.

#### 6.13.2.3 Inserting Send Values

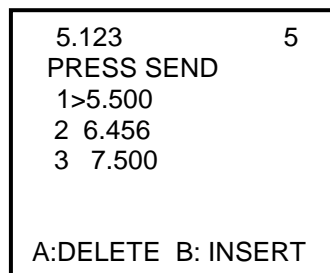

To insert a send value, press the soft-key "A" (EDIT) then the soft-key "B" (INSERT). This moves all send values down and provides a blank line after the current send value.

#### 6.13.2.4 Erasing Send Values

To erase a send value, press the soft-key "A" (EDIT) then the soft-key "A" (DELETE) This will remove the cut value currently being pointed to by the cursor. To backspace over the current send value without removing the line, press the left arrow key.

### 6.13.3 Running a Programmed Job

To use an existing job for cutting, you must first open it by using one of two methods: move the cursor to the desired job with the arrow keys and press ENTER, or enter the job number with the keypad and press ENTER. Once a job has been opened, the current job number will be displayed in the upper right corner. Now press SEND to move the backage to the first programmed position (or send value). Close the front guard and make a cut. Once the cut is made, the backage will automatically push out the paper and move to the next programmed position. After the last cut in the job is made, the backage will move to the first cut position of the current job. Pressing SEND at any time during the job will send the backage to its next programmed position without making a cut.

### 6.13.4 Exiting a Job

To exit an open job, press the soft-key "B" (EXIT) to return to the send mode screen.

## 6.14 An Example Job

The following is an example of how to program a job, which will be used to make two cuts: one at 8.5" and one at 11".

1. Turn on the machine and press CLEAR to preset the backage. Press the soft-key "A" (Job) to go to job mode.
2. Type in a new job number and press ENTER. Note: It must be a number that does not correspond to an existing job. All existing jobs will be displayed on the screen (you may have to scroll through them to see them all). If you wish to replace an existing job with the new job, first erase the existing job by moving the cursor to it and press the soft-key "A" (DELETE). Now type in the new number and press ENTER. In this example, job #'s 1, 2, 5, and 6 already exist. We will use job # 7 for our new job. Press "7" and ENTER.
3. The cursor will move down to the new job number. At this point, press the right arrow key once to move the cursor to the first character position. Now name the job "8.5 X 11". To do this, press "8" on the number key pad. Then press the decimal "." key and so on. To enter the spaces and the letter "X", use the up and down arrow keys to toggle through the alphabet and press the right arrow key to move to the next character position. When the last character has been typed in, the display should look similar to the one shown below:

```

SELECT JOB 1-20
>
  1> 10-BNSCARD
  2> TESTJOB
  5>
  6> BOBS JOB
  7> 8.5 X 11
                                B: Exit

```

Now press ENTER to begin programming the job. The display should now look similar to the one shown next:

```
5.123          7  
SEND TO RUN JOB  
1>  
  
A:EDIT      B: EXIT
```

4. To enter the first send value of 8.5", simply type in 8.5 and press ENTER. The cursor will move to the second line. Now type 11 and press enter.

```
5.123          7  
SEND TO RUN JOB  
1 8.500  
2 11.000  
3>  
  
A:EDIT      B: EXIT
```

At this point, you could leave the job mode by pressing the soft-key "B" (EXIT) to exit to send mode. However, lets use this job to cut paper.

5. Press the SEND key. This will move the backage to the 8.5" position. Place the paper to be cut against the backage, close the front guard, and press the cut button. Once the cut cycle is complete, the backage will push out the paper and move to the next send value (11"). Now position the paper again, close the guard, and make another cut. After the cut is made, the backage will return to the first cut position, ready to repeat the current job.

## 7.0 Knife Installation/Changing

### **CAUTION**

Changing knives can be very dangerous unless safety precautions are observed and extreme care is taken when handling knives.

- Make sure knife lifters are used properly, see instructions following.
- Keep handling of unprotected knives to an absolute minimum.
- Clear off cutter table before removing knife.
- Have scabbard nearby and insert knife immediately.
- Warn people of any unprotected knife.
- Knife changing is a **ONE PERSON OPERATION**. Having more than one person trying to change knives invites accidents.



Figure 13 – Spartan 185 Knife Change Accessories

The knife changing equipment shown in Figure 13 is included with the machine. The following instructions show how to remove and install a new or re-sharpened knife. Read through these instructions **AT LEAST ONCE** before attempting to actually change or install any blades.

### 7.1 Knife Removal

1. With no paper in the machine, make a cut and when the knife reaches the table, continue to hold the left cut button while turning off power with your right hand. This will keep the knife in the down position. Disconnect the machine power cord and remove the right-most knife screw **ONLY**. Restore power to the machine, turn the switch on, and the knife and clamp should move to the “up” position. Turn the main power switch off and disconnect the machine power cord.
2. Raise the knife depth of cut all the way up by turning the knife adjusting screw located on the right side of the machine counterclockwise until it starts to unscrew out of the machine (see Section 6.8 , p. 15). This will ensure the new knife will not cut too deep since a new knife will cut deeper than one that has been ground several times.

NOTE: Failure to raise the knife depth could damage the new knife and/or the cutting stick.

3. Remove the two knife bolts from the slotted knife bar holes **ONLY** and replace with the knife lifter assembly (Figure 14, next page). Tighten the lifters to hold the knife in place, and then remove the remaining three knife bolts.





Figure 14

4. Clear the table surface and place the empty knife scabbard on a flat surface nearby. Remove the scabbard's knife retaining screws.
5. Grasp the knife lifters firmly and, at the same time, turn them counterclockwise to release the knife from the knife bar. Lower the entire assembly down, then move the knife to the left slightly then bring the knife out of the cutter, right end first. Put the blade in the scabbard immediately, remove the knife lifter assembly, and secure the knife with the knife retainer screws.
6. Send dull knives to a knife grinder – do not attempt to sharpen your own knives! Knives that do not have a minimum height of 2-3/8" (6.0 cm) will not function properly and should be carefully discarded. See the Knife Care Tips Section 7.3 page 25 for additional information.

## 7.2 Knife Installation

### **⚠ CAUTION**

Knives are heavy and always very sharp! Be sure to keep the edge away from your body and keep other people out of the area while handling the blade. Severe lacerations or dismemberment could result from careless handling procedures.

1. Make sure the knife and clamp are in the "up" position. Turn the main power switch off and disconnect the machine power cord to prevent accidental power-up while servicing the cutter.
2. Pull out the cut stick and turn it to a new surface or replace with a new one.
3. Remove the retainer screws from the new blade and screw the knife lifters into the new blade. Screw the lifters about half way into the knife.
4. Insert the knife assembly into position under the knife bar, left end first. Raise the knife into the knife bar slot as high as it will go. Check both view holes to make sure knife is all the way up (Figure 15). Then tighten the lifters.

**NOTE:** If the blade will not go in, make sure the lifters are not screwed into the blade too far.

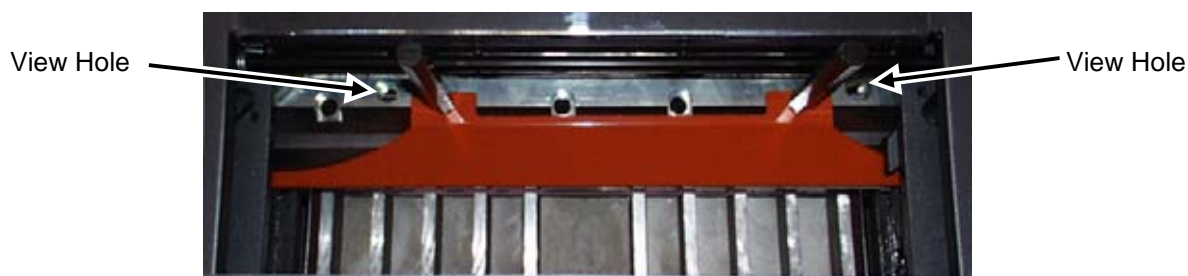

Figure 15

5. Insert and tighten the three accessible knife bolts.
6. Remove the knife lifter assembly and replace with the two knife bolts.
7. Plug in power cord, turn power on, close the shield and press the cut buttons to send knife and clamp down. Continue to hold the left cut button while turning off power with your right hand. This will keep the knife in the down position. Disconnect the machine power cord and insert and tighten the right-most knife screw.
8. Restore power to machine, and place a few sheets of paper over the cut stick, covering the stick end-to-end.
9. Double check to make sure the knife depth adjusting screw has been adjusted up (step #2, Knife Removal). Plug in the power cord, turn the power on, close the shield, and press the cut buttons to perform a cut cycle.
10. If the knife does not cut all the way through (and it shouldn't on the first try), adjust the knife depth of cut by turning the adjusting screw on the right side of the machine, about one complete turn at a time to start. Continue to make cuts and adjustments until the knife cuts through all sheets. Remove paper and cut through a few larger lifts of paper to make sure the knife depth is set correctly. Adjust again if necessary.
11. Send dull knives to a knife grinder – do not attempt to sharpen your own knives! Knives that do not have a minimum height of 2-3/8" (6.0 cm) will not function properly and should be carefully discarded. See the Knife Care Tips Section 7.3 page 25 for additional information.

### 7.3 Knife Care Tips

#### **CAUTION**

**! KNIFE SAFETY !** Knives are **DANGEROUS!!!** Knives are very sharp, even after use. Keep the edge away from your body and keep the area clear of others when handling knives. Never touch the cutting edge! To prevent personal injury and damage to the knife, always keep knives in their holders with screws tightened. Even if you are aware of the dangers, others may not be. Never attempt to hone, polish, or service the knife in any way. Failure to follow safety procedures may result in severe lacerations or dismemberment.

#### 7.3.1 Knife Blade Life

Knife blade life, or the time between sharpening, can be affected by many factors. One important factor is the type of paper being cut. Abrasive paper, such as recycled paper, soft paper such as newsprint paper, and bound books can all significantly shorten knife blade life. Also, if the knife depth is set too deep, the knife will cut too deep into the cutting stick and can quickly dull the knife blade.

A knife can last between 2,000 and 5,000 cuts before it needs to be sharpened. Cutting soft paper (such as newsprint paper) or paper with high post-consumer recycled content can cause the knife to need sharpening after only 2,000 to 3,000 cuts. Cutting pure paper, such as bond paper with no recycled content, or hard paper can allow the knife to be used for as many as 5,000 cuts before it needs to be sharpened. In all cases, the operator should continually check the quality of the cut to determine when the knife blade needs to be sharpened. Some characteristics that indicate a blade needs sharpening are:

- The knife hesitates or stalls while making a cut.
- The sheets are not all cut to the same length (usually the top few sheets are longer than the rest of the sheets - this is sometimes called "draw").

## 7.0 Knife Installation/Changing

---

- Cut marks appear on the cut face of the paper.
- The profile of the cut (side view) is not perpendicular to the table.
- The cut does not appear straight when viewed from the top.
- The knife makes a “rough” sound as it passes through paper.
- Nicks are visible on the cutting edge of the knife.

### 7.3.2 Cutting Stick

A worn cutting stick can affect the cut quality of the bottom sheets. When this happens, the cut stick can be rotated. Usually, the stick should be rotated one or two times between knife sharpening. Cut sticks have a “wavy” shape to them and when rotated must be rotated a full 180° to keep a flat side up. Each stick has 2 flat sides that can be used, after which it can be turned end to end, allowing the 2 flat sides to be used again, for a total of 4 positions per cut stick.

### 7.3.3 Bevel Angle

Challenge recommends that bevel angles for the Spartan 185 knives be 21°.

### 7.3.4 Helpful Suggestions

- It may be helpful to own a “set” of knives. A set consists of 3 knives: one in the machine, one as back up, and one at the grinder.
- If the machine seems to strain but the cut quality is still good, reduce the pile height. You may also carefully apply glycerin to the bevel when cutting hard, coated paper. Tie a cloth to the end of a stick; dip the stick in glycerin, and apply. Never apply by hand! In lieu of glycerin you may lightly rub white bar soap along the bevel. Lubrication will prolong the life of your machine and reduce maintenance.

### 7.3.5 Knife Care

- To prevent corrosion, knives are coated with light oil. It should be REMOVED WITH CARE.
- While removing or installing a knife, be careful not to allow the edge to bump against the machine. Nicks will result.
- If a knife bolt is damaged, replace it.
- Always keep knife bolts securely tightened.
- Store knives in a dry environment to prevent corrosion.
- Never attempt to hone, polish, or service the knife in any way.

## NOTES

# 8.0 Maintenance and Troubleshooting

## 8.1 Maintenance



**CAUTION** All maintenance on this machine should be performed by trained service personnel. Attempting to perform repair and replacement procedures without proper training may cause machine damage or operator injury!

## 8.2 Troubleshooting

Problem	Possible Cause	Solution
1. The machine will not power up – no display, no line light, and machine will not cycle.	<ul style="list-style-type: none"> <li>a) Power cord is disconnected.</li> <li>b) Main power switch/circuit breaker is off.</li> <li>c) No power at electrical outlet.</li> </ul>	<ul style="list-style-type: none"> <li>a) Plug in cord.</li> <li>b) Turn power switch/circuit breaker on.</li> <li>c) Check outlet. Repair or use another outlet.</li> </ul>
2. Display and line light are on, but machine will not cycle.	<ul style="list-style-type: none"> <li>a) Front guard is open.</li> <li>b) Front guard has not been opened and closed since previous cut cycle.</li> <li>c) Power Clamp Breaker Switch is tripped</li> </ul>	<ul style="list-style-type: none"> <li>a) Close front guard.</li> <li>b) Open and close front guard.</li> <li>c) Reset breaker switch. See page 11).</li> </ul>
3. Backgauge display shows: “----“.	<ul style="list-style-type: none"> <li>a) Backgauge has not been preset.</li> </ul>	<ul style="list-style-type: none"> <li>a) Preset Backgauge by bringing backgauge to front of machine</li> </ul>
4. Knife cuts deeper on one side than the other.	<ul style="list-style-type: none"> <li>a) Knife is not seated all the way up in knife bar.</li> </ul>	<ul style="list-style-type: none"> <li>a) Loosen knife screws and use knife lifter assembly to raise knife up tight. See Section 7.2 Knife Installation, page 24.</li> </ul>
5. The machine strains through a cut.	<ul style="list-style-type: none"> <li>a) Dull knife.</li> <li>b) Inadequate power source.</li> </ul>	<ul style="list-style-type: none"> <li>a) Change the knife with a new or sharpened one. See Section 7.0 Knife Installation/Changing, page 23 for instructions.</li> <li>b) The electrical outlet may not have sufficient power if other equipment is operating on the same line. Try another outlet on a different line.</li> </ul>
6. Concave cutting – ends wide, center narrow.	<ul style="list-style-type: none"> <li>a) Excessive moisture at edges of paper.</li> </ul>	<ul style="list-style-type: none"> <li>a) Keep paper in dry location.</li> </ul>
7. Concave cutting – variation from top to bottom.	<ul style="list-style-type: none"> <li>a) Knife dull or incorrectly ground.</li> </ul>	<ul style="list-style-type: none"> <li>a) Change the knife with a new or sharpened one. See Section 7.0 Knife Installation/Changing, page 23 for instructions.</li> </ul>

# 9.0 Footprint

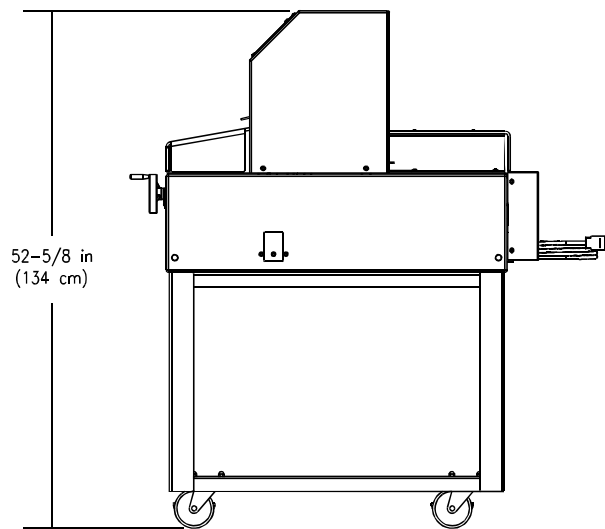
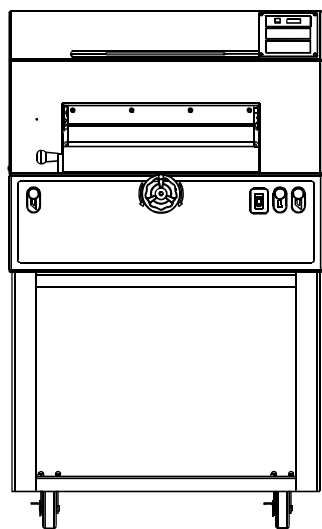
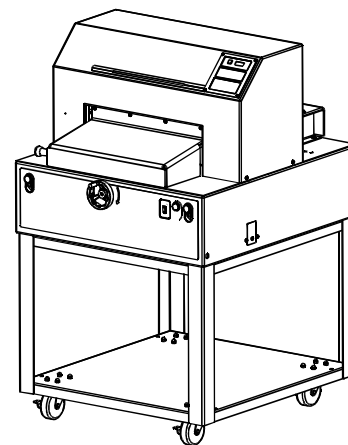
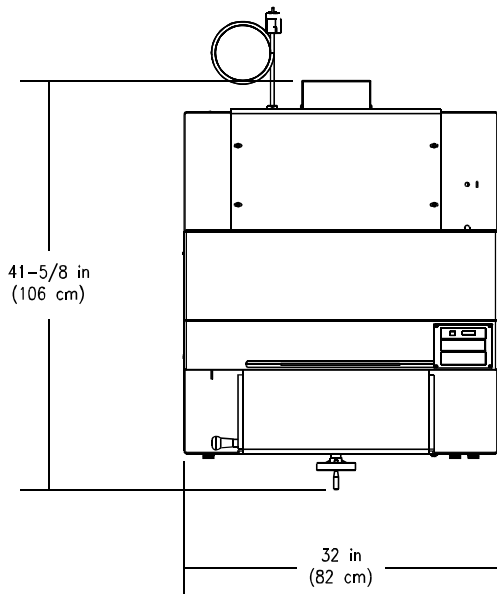

# 10.0 Safety Systems Test

---

Machine manufacturer CHALLENGE

Model SPARTAN 185 AEP

Serial Number \_\_\_\_\_

Frequency of test: **THESE TESTS SHOULD BE PERFORMED AT THE BEGINNING OF EACH WORK DAY.**

Turn the power on and make sure the knife and clamp are in the up position (if they are not, follow the instructions in this manual to send them up).

Test #1: With the front shield open, press the cut buttons. Nothing should happen. If the knife comes down with the front guard open, do not use the machine. Repair or adjustment is needed.

Test #2: Close the front guard and press the cut buttons. While the knife is coming down, open the front shield. The knife should immediately return to the up position. If it does not, do not use the machine. Repair or adjustment is needed.

