

# ***Dahle PowerTEC 909 HS*** ***High Capacity Industrial Shredder***

Product Spec Sheet



*Provided by*

**MyBinding.com**

*When Image Matters.*

Call Us at 1-800-944-4573

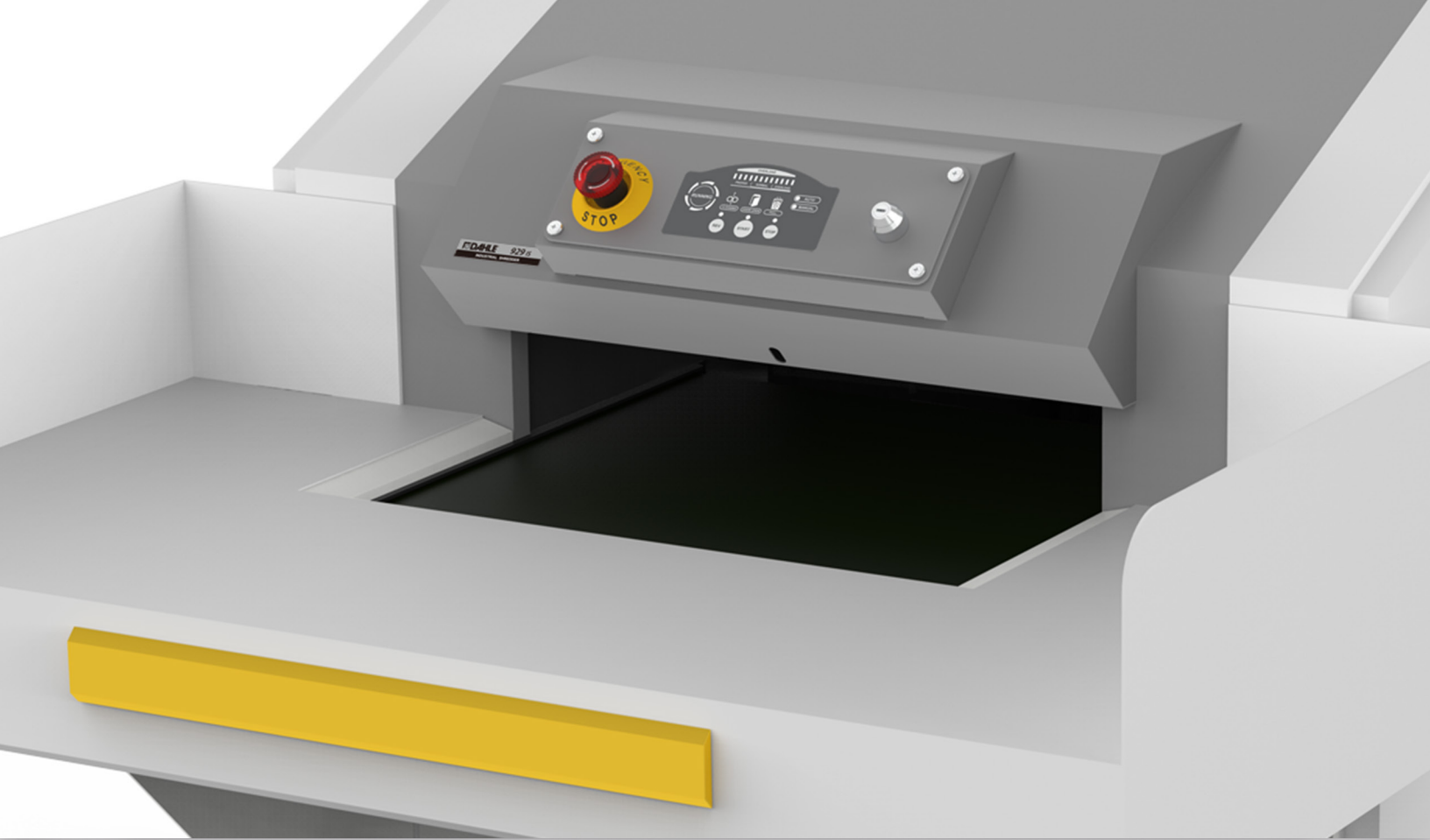

# Industrial

## High Volume Data Destruction

Dahle's PowerTEC® 900 Series Industrial Shredders are high capacity machines capable of destroying large volumes of sensitive information quickly. They feature a powerful chain driven motor, automatic jam protection, and simple push button operation. These shredders are rated for Security Level P-3 destruction and can hold up to 120 gallons of waste. For added convenience, output conveyor belts are available for the PowerTEC® 919 IS and 929 IS to deliver shredded waste to a large recycling bin or baler.

### Media Types



### Special Features

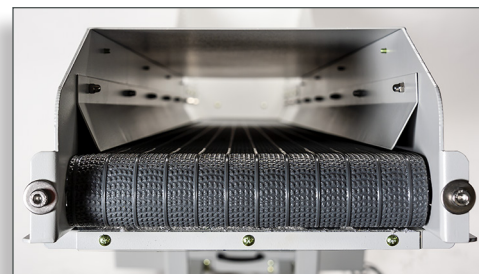
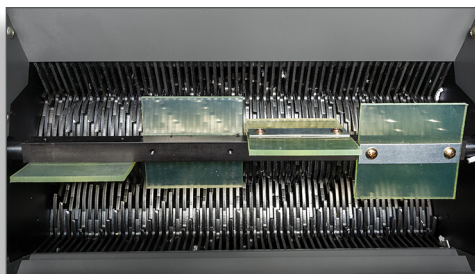
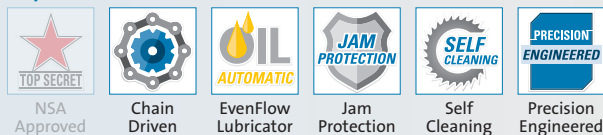

# PowerTEC® 909 HS Industrial Shredder

*Shreds High Volume Paper | Optical Media*

- Security Level P-3 for the destruction of sensitive information
- Mighty 5 Hp continuous duty motor with chain driven operation
- Automatic EvenFlow Lubricator provides continuous oil
- Automatic jam protection eliminates frustration
- LED keypad with easy-to-use controls for simple operation
- Self-cleaning mode ensures optimal performance
- Center folding table can be lifted and used for high volume shredding



# PowerTEC® 919 IS Industrial Shredder

*Shreds High Volume Paper | Binders | Optical Media*

- Security Level P-3 for the destruction of sensitive information
- Mighty 5 Hp continuous duty motor with chain driven operation
- Automatic EvenFlow Lubricator provides continuous oil
- Automatic jam protection eliminates frustration
- LED keypad with easy-to-use controls for simple operation
- Rubber shock mounts suspend the cutting head and reduce vibration
- Optional output conveyor (919 CB) available for high volume waste disposal

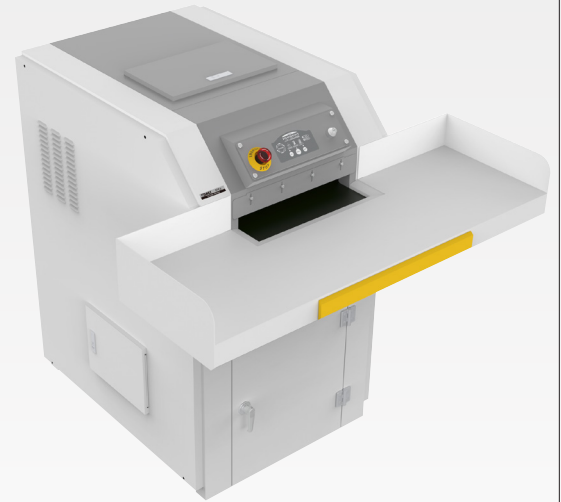
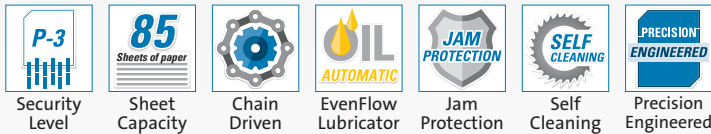

# PowerTEC® 929 IS Industrial Shredder

*Shreds High Volume Paper | Binders | Optical Media*

- Security Level P-3 for the destruction of sensitive information
- Mighty 11.5 Hp continuous duty motor with chain driven operation
- Automatic EvenFlow Lubricator provides continuous oil
- Automatic jam protection eliminates frustration
- LED keypad with easy-to-use controls for simple operation
- Rubber shock mounts suspend the cutting head and reduce vibration
- Optional output conveyor (929 CB) available for high volume waste disposal



## SPECIFICATIONS

Model	Security Level	Capacity #20 / #16	Shred Size	Waste Volume paper   media	Feed Width paper   media	Speed f/m	Motor	Decibel Level	Warranty	Dimensions length x width x height	Weight	Power Supply
909 HS	P-3	85 / 90	4mm X 50mm	68 gal.	17.5"	39	5 Hp	60	1 year	30" x 30" x 64.25"	992 lbs	220v 3 Phase
919 IS	P-3	85 / 90	5mm X 40mm	45 gal.	16"	39	5 Hp	65	1 year	52" x 47.25" x 48.5"	1,080 lbs	220v 3 Phase
929 IS	P-3	500	8mm X 40mm	120 gal.	21.5"	33	11.5 Hp	70	1 year	78.75" x 48" x 64.5"	3,175 lbs	220v 3 Phase

## PowerTEC® 919 CB Conveyor Belt

*Output Conveyor Belt for PowerTEC® 919 IS*

- 16 Inch wide rubber conveyor belt rapidly removes shredded waste
- Provides unlimited waste volume to PowerTEC® 919 IS
- 50" delivery height for easy placement above a recycling bin or baler
- Adjustable output speed with the turn of a dial
- Plugs directly into PowerTEC® 919 IS- no additional power needed
- Steel construction with rolling casters for easy placement



## PowerTEC® 929 CB Conveyor Belt

*Output Conveyor Belt for PowerTEC® 929 IS*

- Extra large 21.5 inch wide rubber conveyor belt rapidly removes waste
- Provides unlimited waste volume to PowerTEC® 919 IS
- 46" delivery height for easy placement above a recycling bin or baler
- Adjustable output speed with the turn of a dial
- Plugs directly into PowerTEC® 929 IS- no additional power needed
- Steel construction with rolling casters for easy placement

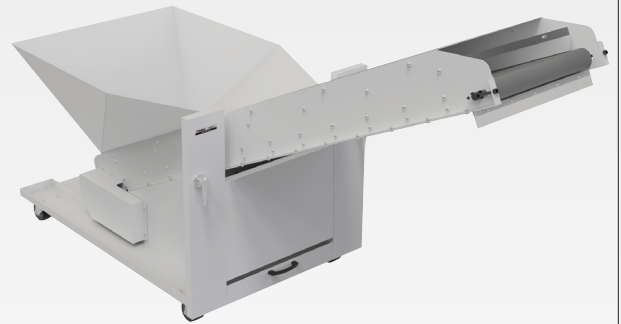

### SPECIFICATIONS

Model	Belt Width	Speed f/m	Decibel Level	Warranty	Dimensions length x width x height	Weight	Power Supply
919 IS	16"	49	65	1 year	92.25" x 25.75" x 50.5"	276 lbs	220v (plugs into 919 IS)
929 IS	21.5"	49	65	1 year	83.25" x 30" x 46"	276 lbs	220v (plugs into 929 IS)