

Logan F502 Frame Backing Kit

Instruction Manual



Provided by

MyBinding.com
When Image Matters.

Call Us at 1-800-944-4573

INSTALLING HANGING WIRE, BUMPER PADS & SAW TOOTH HANGER

Installing D-Rings

Several options exist for hanging your artwork, but the general method utilizes picture hanging wire because it provides the greatest ease and flexibility with artwork of any size. In recent years, strap hangers with D-rings have grown in popularity over screweyes, because they lie flat against the back of the dust cover and won't scratch the wall.

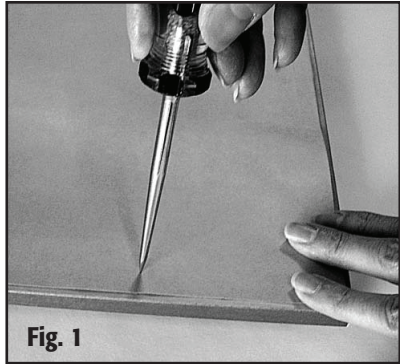

To position D-Rings, measure about one-third down from the top of the frame and mark the location. Do this on both sides. Nylon-coated hanging wire comes in three strengths: 19 lb., 25 lb. and 43 lb. Each strength is a measure of the weight-bearing capacity of the wire. If the framed piece is too heavy for the wire, the wire will unravel, pulling free of the hangers, regardless of the complexity of the knots used.

To attach D-Rings to soft or medium wood frames, make a pilot hole in the back of the frame with a scratch awl. Turn the screw into the wood with a screwdriver (**Fig. 1**). To attach a D-Ring into hardwood frames, drill a hole with a power drill and attach the screw with a power screwdriver (**Fig. 2**).

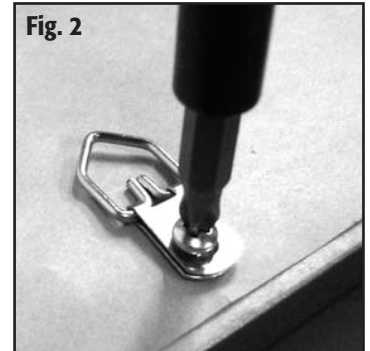

Installing Wire

To install the wire, insert one end through the D-Ring allowing 3-5 inches of wire to feed through, twist it around itself and loop it through the D-Ring one more time. Pull tight and then coil the excess around itself keeping the coil tight and cutting away any excess after finishing. (**Fig. 3**)

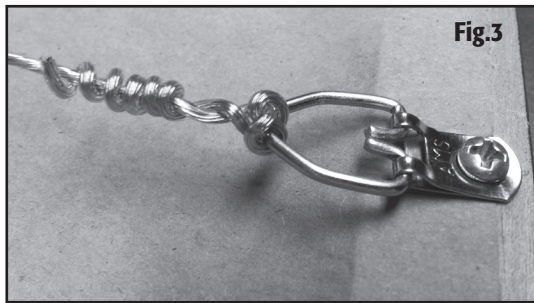

Stretch the wire across through the other D-Ring allowing 3-5 inches of excess, use a finger to pull up slightly in the center of the wire to create some slack in the middle of the wire and repeat the tying and coiling process. (**Fig. 4**)

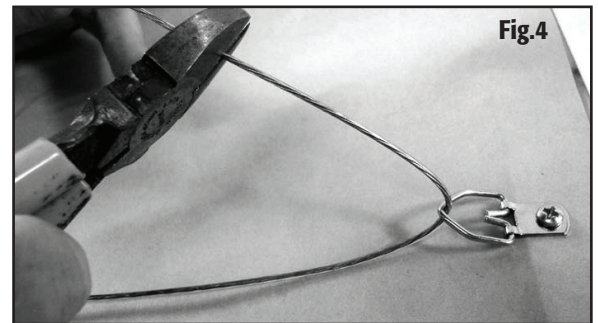

Attaching Bumper Pads

For a nice finishing touch, attach self-adhesive bumper pads to bottom corners on the back of your frame. These will prevent the frame from scratching the wall, allow air circulation behind the frame to help prevent any condensation and allow some light behind the frame to help prevent fading of wall paint color. (**Fig. 5**)

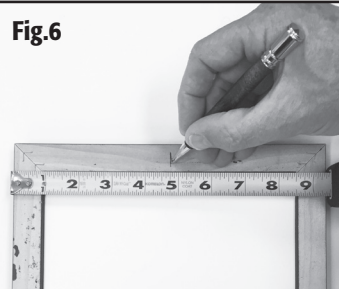
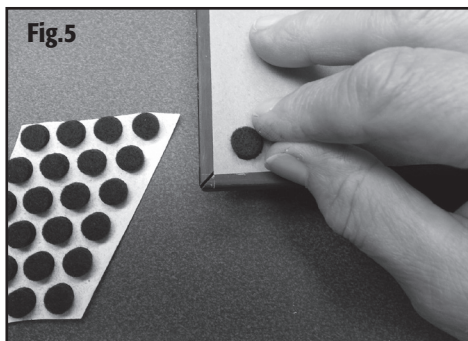

Installing Saw Tooth Hanger

Saw tooth hangers are typically used on frames up to 16" x 20" and weigh no more than 10 lbs.

To attach saw tooth hanger, place frame face down on a soft protected surface like cardboard. Next, mark a line at the center of the top of the frame (**Fig. 6**). Align the center dot of the hanger over the mark (**Fig. 7**). Make sure the hanger teeth are pointing toward center of frame. Using a hammer, tap hanger leg into wood frame one leg at a time (**Fig 8**).

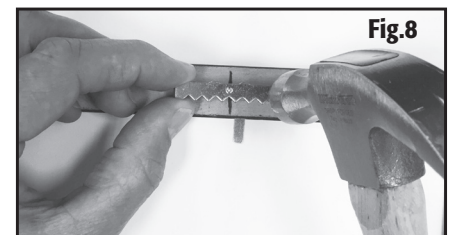
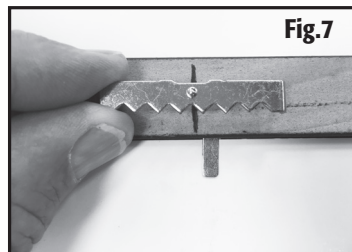

DUST COVER TRIMMER

Operating Instructions

Blade install: (Fig. 1)

1. Determine right hand or left hand usage.
2. Remove nut and three (3) blades.
3. Separate and install one blade, sharp edge down.
4. Slide cover to "safe" when not using and "blade" when ready to use.

Apply dust cover:

1. Using double sided tape, ATG tape or glue, apply continuous line around back of frame about 1/8" from edge. **(Fig. 2)**
2. Cut a piece of Kraft paper (30, 40, or 50 lb available at craft stores) that is larger than overall outside of frame by a minimum of 1".
3. Lay paper flat onto table and drop the frame straight down onto the paper with taped side down and artwork side facing up. **(Fig. 3)**
4. Crease paper along the edges of the frame. **(Fig. 4)**
5. Using trimmer, start beyond edge of a corner, hold on slight angle up against frame edge. Draw trimmer along edge to trim. Repeat for other three sides. **(Fig. 5)**
6. Using water in a spray bottle, completely dampen Kraft paper evenly. As water dries, the paper will shrink tight. **(Fig. 6)**

NOTE: Use a hairdryer to speed up drying time.

