

Luxor 60" x 40" Magnetic Wall-Mounted Glass Board

Instruction Manual



Provided by

MyBinding.com
When Image Matters.

Call Us at 1-800-944-4573

LUXOR

Magnetic Wall-Mounted Glass Board Instructions

WGB4836M | WGB6040M | WGB7248M | WGB9648M

Tools Required:

Phillips Head
Screwdriver

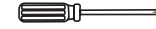

Drill



- Use a 1/4" drill bit to create pilot holes for the included anchors.
- Use a 1/8" drill bit to create pilot holes for screwing directly into studs.

Parts List - WGB4836M & WGB6040M:



A x 6



B x 6



C x 2



D x 2



E x 2



F x 1



A x 9



B x 9



C x 3



D x 3



E x 3



F x 1

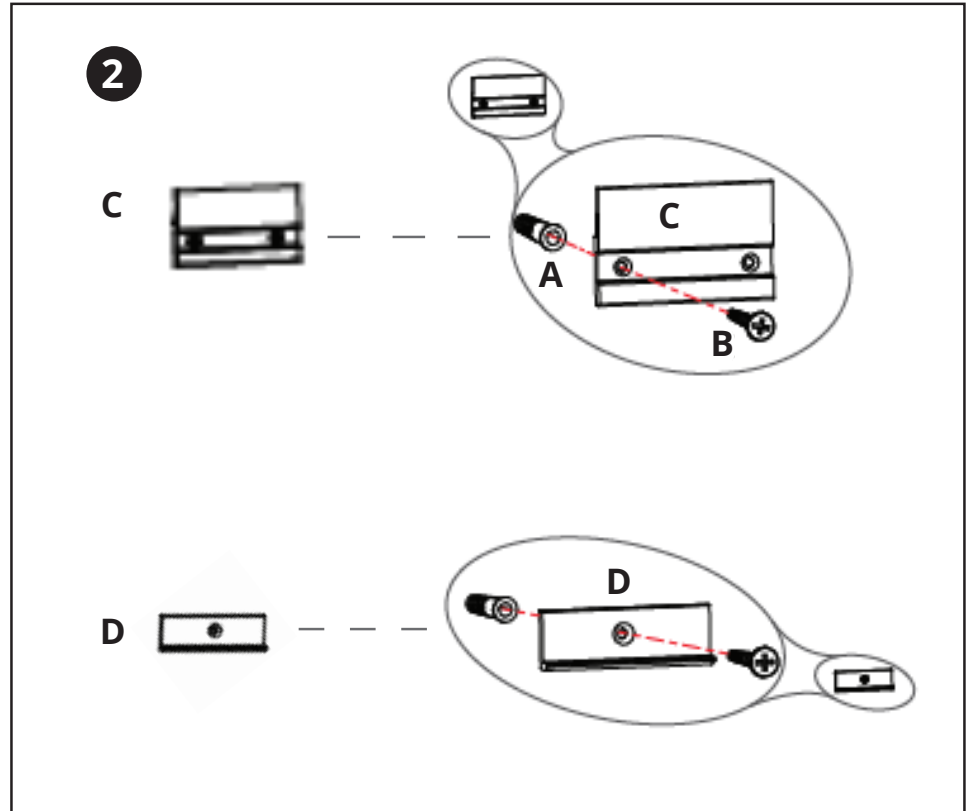
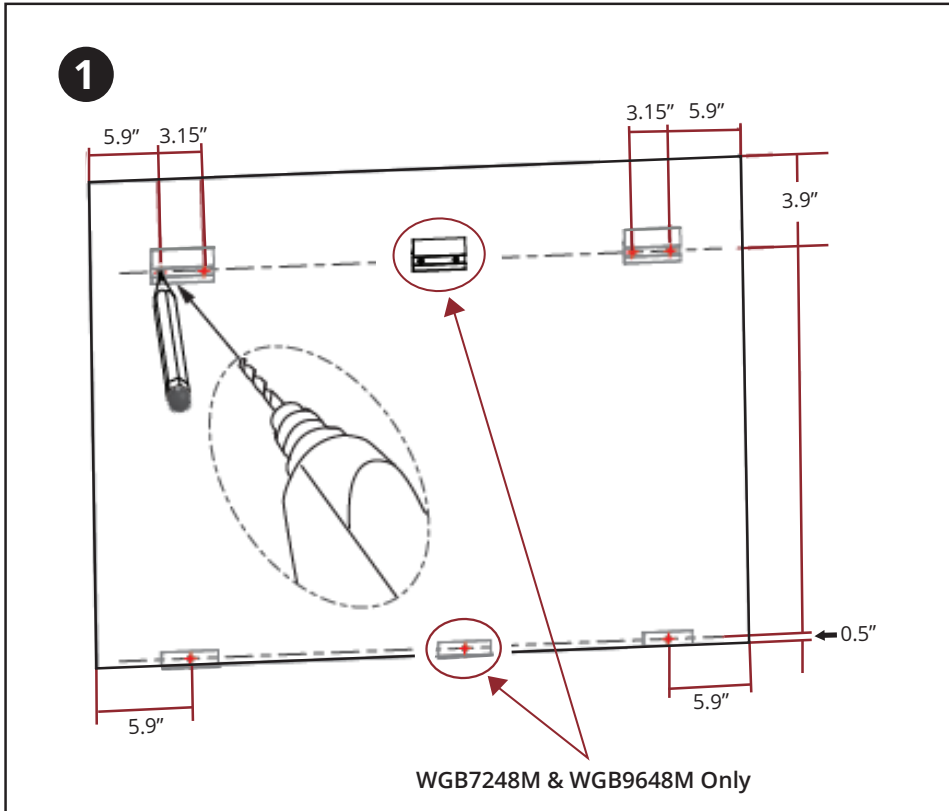

3

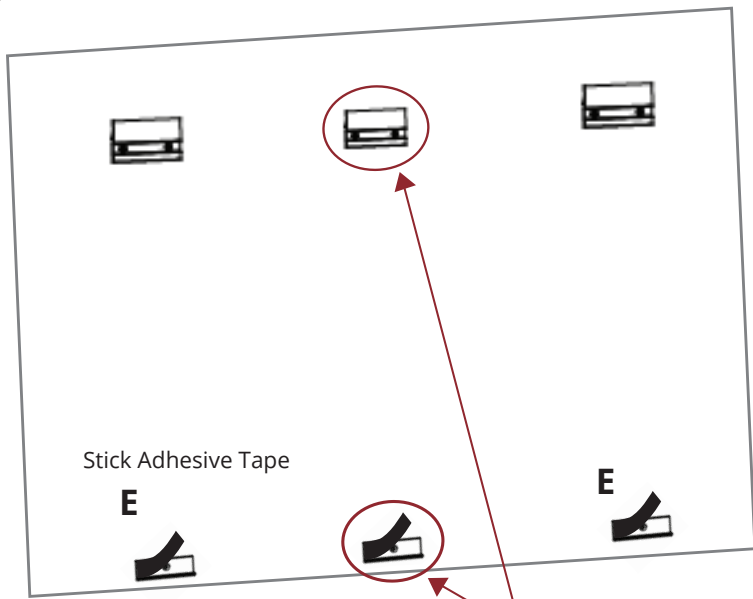

WGB7248M & WGB9648M Only

4

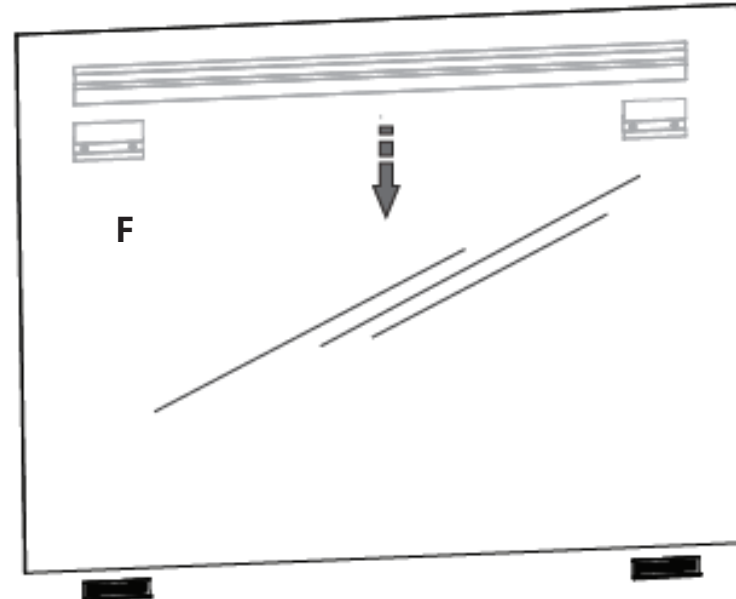

9620 NE Tanasbourne, Dr. Suite 250,
Hillsboro, OR 97124

Email or Call Us for Orders or Inquiries

sales@mybinding.com

1-800-944-4573