

Luxor 72" x 48" Magnetic Wall-Mounted Glass Board

Instruction Manual



Provided by

MyBinding.com
When Image Matters.

Call Us at 1-800-944-4573

Tools Required:



- Use a 1/4" drill bit to create pilot holes for the included anchors.
- Use a 1/8" drill bit to create pilot holes for screwing directly into studs.

Parts List - WGB4836M & WGB6040M:

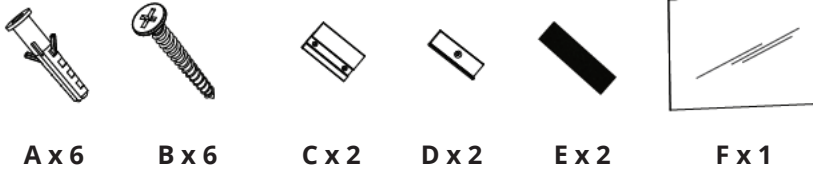

A x 6 B x 6 C x 2 D x 2 E x 2 F x 1

Parts List - WGB7248M & WGB9648M:

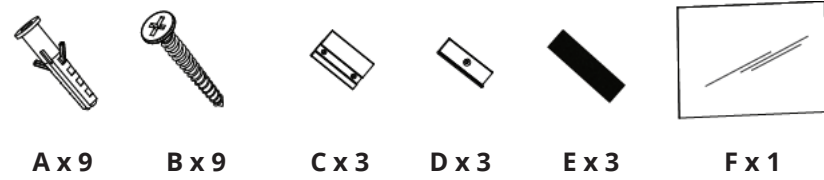

A x 9 B x 9 C x 3 D x 3 E x 3 F x 1

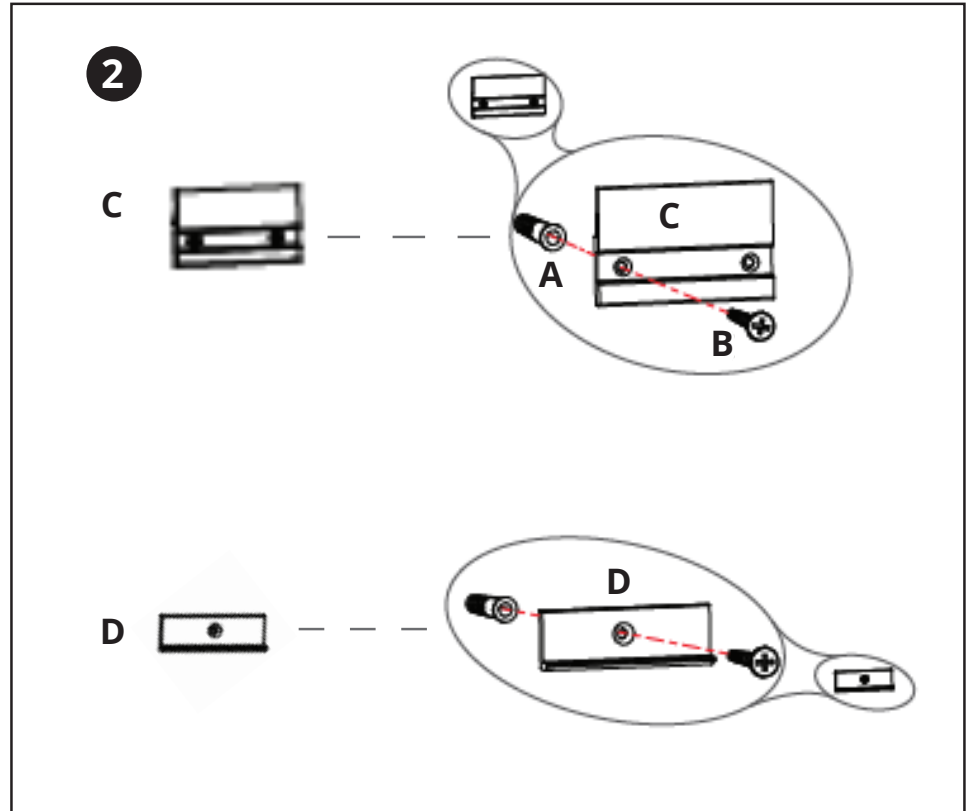
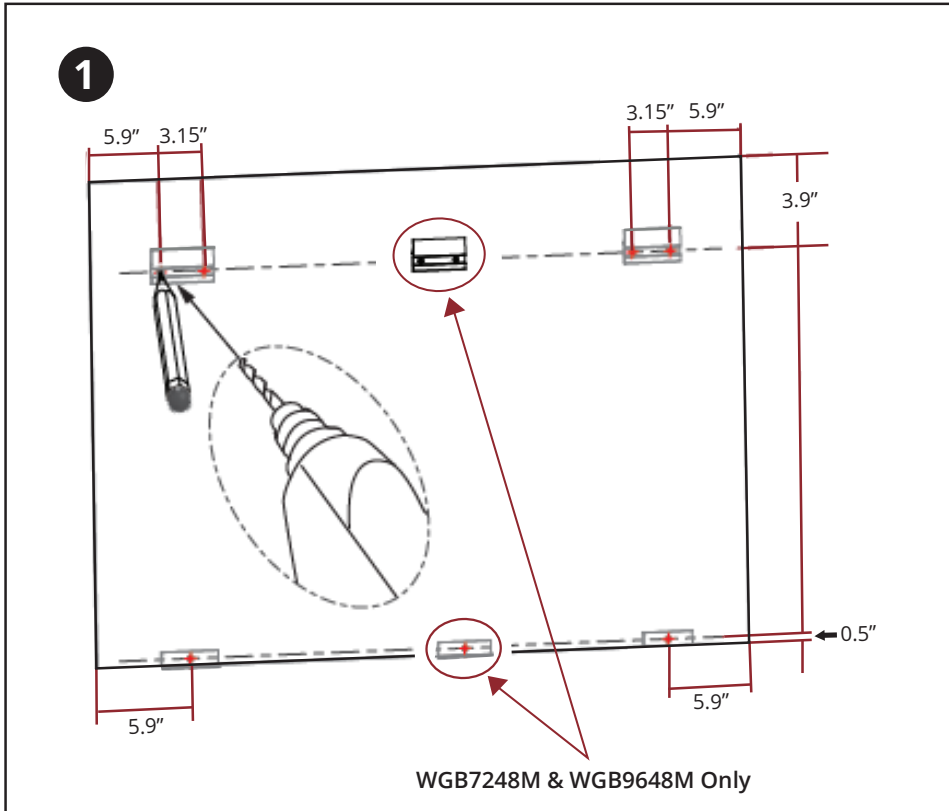

3

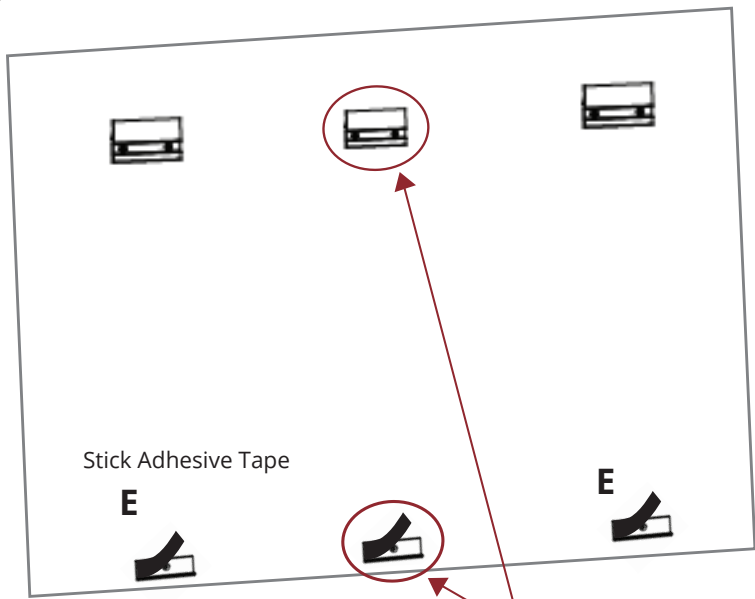

WGB7248M & WGB9648M Only

4

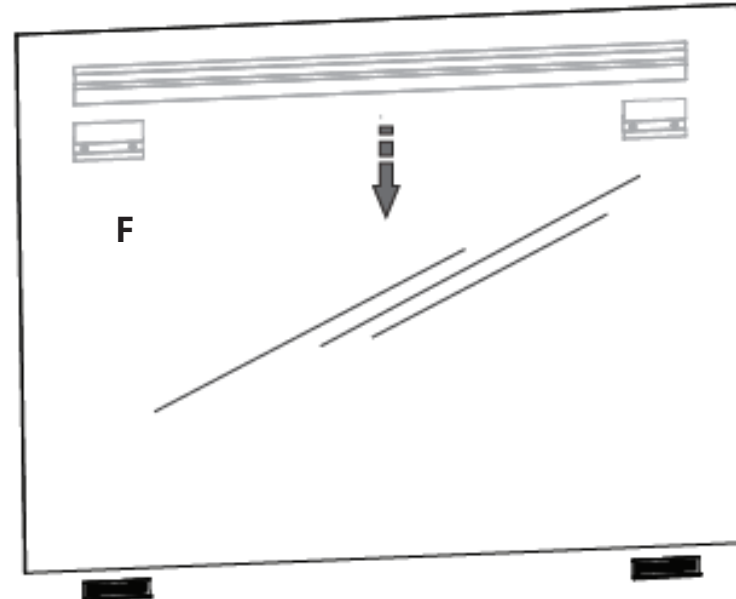

9620 NE Tanasbourne, Dr. Suite 250,
Hillsboro, OR 97124

Email or Call Us for Orders or Inquiries

sales@mybinding.com

1-800-944-4573