

PC 2000 Coil Inserter and Hand Punch

4:1 (PC 2004) and 5:1 (PC 2005)

Setup & Operator Manual

Issue 0 April 05

Performance Design Inc.



The PC 2000 plastic spiral inserter and hand punch will bind books up to 1-1/8" (28.6mm) thick using coil diameters from 3/16" (5mm) up to 1-1/4" (30mm). Any pitch coil can be inserted with this machine. Easily punches 12 sheets 20 lb. or 80 gsm bond at 4:1 or 5:1 pitch.

Table of contents

Topic:	Page Number
1) Installation Instructions.	2
2) Determine the correct coil size.	3
3) Determine the correct size mandrel.	3
4) Installing the mandrel on the machine.	4
5) Adjusting the mandrel bracket.	4
6) Adjusting the book guides.	5
7) Adjusting the front table / coil guide.	5
8) Forward / off / reverse switch.	6
9) Inserting a coil.	6
10) Drive wheel stop screw.	7
11) Cutting a coil.	7
12) Pin Removal or Replacement and Waste tray.	9
13) Punching paper.	10
14) Troubleshooting.	11

1) Installation Instructions: Diagram 1 next page.

Important Safety Notice!

Make sure you read this section very carefully! Learn to recognize this **Safety Alert Symbol**.

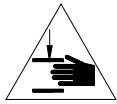

Keep all clothing and jewelry away from rotating drive wheel.



Power cord shall be certified for the country where the machine will be installed!

Please see Diagram 1 next page.

- ◆ Place the PC 2000 on a sturdy table at a good working height.
- ◆ Use two knobs and washers for each guide and table installed.
- ◆ Place the **right side book guide (spare mandrel holder) (1)** next to the drive wheel.
- ◆ Attach the **book table / coil guide (2)** to the front of the PC 2000.
- ◆ Place **stop screw & spring (3)** onto front of PC 2000.
- ◆ Use the large winged knob and washer to install the **coil chute / mandrel holder (4)** to side of PC 2000.
- ◆ Thread **Motor handle (5)** into motor mount.
- ◆ Plug one end of the power cord into the back of the PC 2000 and the other end into the wall outlet.

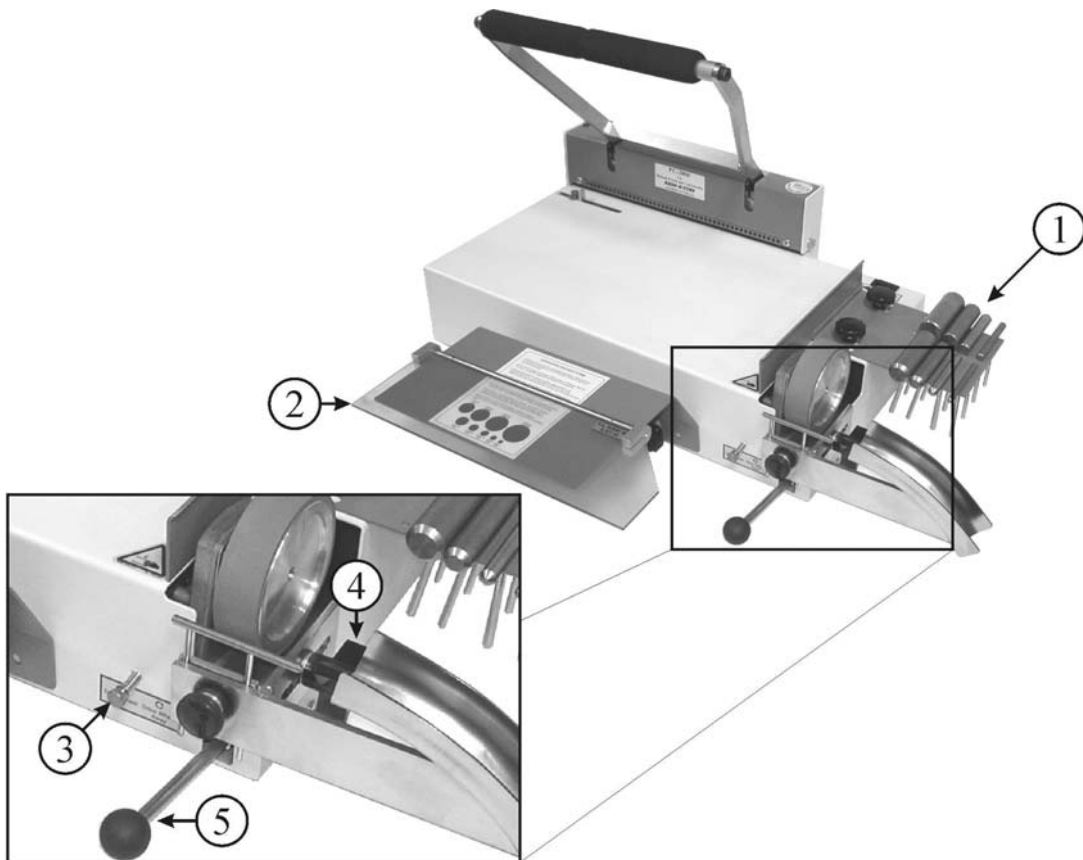

Diagram 1

2) Determine the correct coil size.

Use a coil that is at least $\frac{3}{32}$ " (2.5mm) larger than the book thickness for coil sizes up to $\frac{3}{4}$ " (20mm). After $\frac{3}{4}$ ", use a coil size of at least $\frac{1}{8}$ " over the book size. The larger the coil compared to the book, the easier the insertion.

3) Determine the correct size mandrel.

There are a total of nine mandrels, which are used for coil sizes $\frac{3}{16}$ " (5mm) up to $1\frac{1}{4}$ " (30mm). Use the table below, to choose the correct mandrel size to coil size.

Mandrel size	Inch	Coil size	mm
$\frac{3}{16}$ "	3-16" to 1/4"	(5mm-6mm)	
$\frac{1}{4}$ "	$\frac{5}{16}$ "	(7mm-8mm)	
$\frac{5}{16}$ "	$\frac{3}{8}$ "	(9mm-10mm)	
$\frac{3}{8}$ "	$\frac{7}{16}$ " to $\frac{1}{2}$ "	(11mm-12mm)	
$\frac{1}{2}$ "	$\frac{9}{16}$ "	(13mm-16mm)	
$\frac{5}{8}$ "	$\frac{3}{4}$ "	(17mm-19mm)	
$\frac{3}{4}$ "	$\frac{7}{8}$ "	(20mm-23mm)	
$\frac{7}{8}$ "	1"	(24mm-27mm)	
1"	$1\frac{1}{8}$ " to $1\frac{1}{4}$ "	(28mm-30mm)	

4) Installing the mandrel on the machine. Diagram 2



Keep all clothing and jewelry away from drive wheel during coil insertion!

- ◆ Place the **mandrel (1)** into the **mandrel holder bracket (2)** making sure the **beveled edge (3)** of the mandrel is facing the right side of the machine. Both guide posts located on the mandrel need to line up with both slots on the mandrel bracket. Use the **black knob (4)** to tighten the mandrel in place.
- ◆ Adjust the height of the mandrel so the center of the mandrel is the same height as the center of the book.

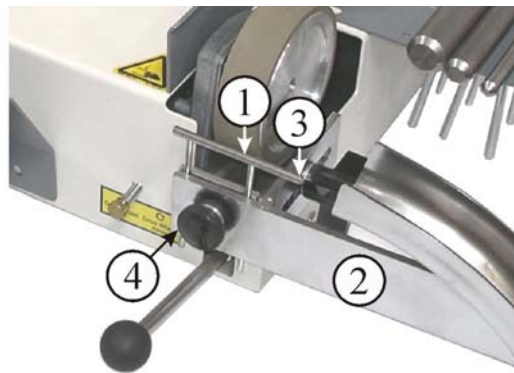

Diagram 2

5) Adjusting the mandrel bracket. Diagram 3

- ◆ The **coil chute / mandrel holder adjustment knob (1)** is located on the right side of the PC 2000. Move the assembly toward the drive wheel for small mandrels and away from the drive wheel for the larger mandrels.

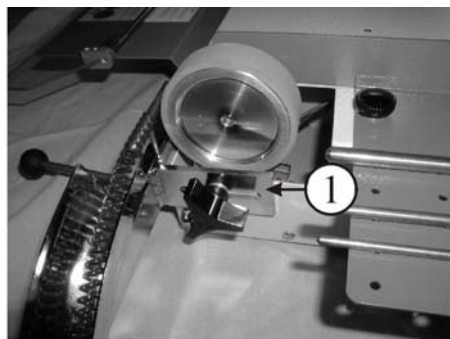

Diagram 3

6) Adjusting the book guides. Diagram 4

The **right side book guide (1)** can be adjusted slightly to the left or the right so the leading edge of the coil lines up with the first hole of the book.

Place the book on top of the PC 2000 with the right side of the book against the right side book guide (1). Tighten the two knobs at this time. Adjust the book so the holes of the book hang over the **edge (2)** of the PC 2000. **The holes should hang over the edge just enough for the coil to clear the edge of the machine.** It may be necessary to fine-tune this after a few books are bound for exact placement.

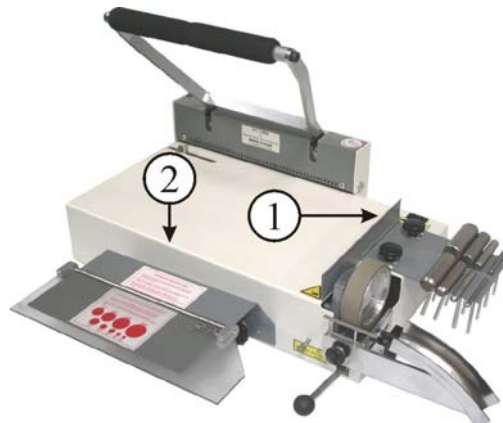

Diagram 4

7) Adjusting the front table / coil guide. Diagram 5

The **front table/ coil guide (1)** has two purposes. When the coil guide is rotated on top of the coil, it helps assist the coil into the book. Use the coil guide with all book sizes (thickness) until you notice a problem with the coil slipping on the drive wheel or entering the holes in the book; When the coil guide is in the open position, **rotated away from the machine**, it acts as a **support table (2)** for larger books. For books over 9/16", it may be necessary at times to split the book in half using the table to support one half of the book, then finish the inserting of the coil. This method improves productivity.

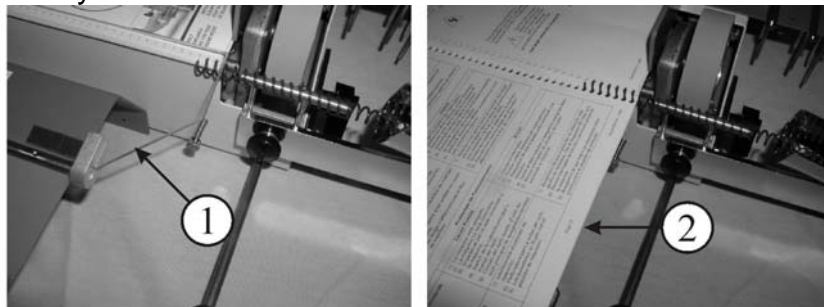

Diagram 5

8) Forward / off / reverse switch. Diagram 6

The **forward / off / reverse (1)** switch has three positions. The center position of this switch is the off position and should be placed in this position when not using the machine. Press the left side (forward) of the switch and the coil will rotate into the book. Press the right side (reverse) of the switch and the coil will exit the book. The reverse feature allows the coil to be removed from the book. Sometimes this will be necessary when the leading edge of the coil misses a hole of a single sheet. The wheel will not rotate until the handle is pushed down.

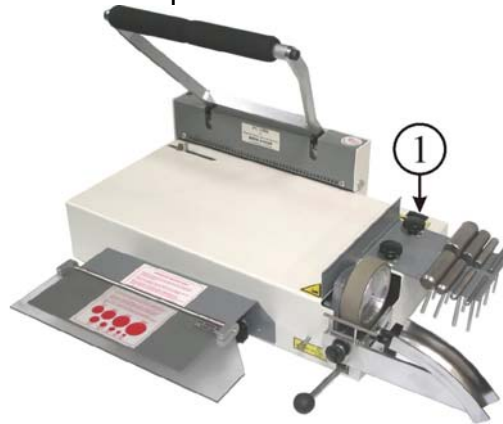

Diagram 6

9) Inserting a coil. Diagram 7

Place the coil on the mandrel by sliding the open end of the coil onto the beveled end of the mandrel. Turn the coil so it threads onto **the mandrel post (1)** and is in front of the drive wheel by one coil. Make sure the forward / reverse switch is in the forward position. Pull the **motor handle (2)** down to start the motor and engage the **drive wheel (3)** to the coil. Rotate the coil so it comes close to the edge of the book, but not past the book. With your right hand, hold the leading edge of the coil and thread it through the first two holes of the book. This helps align the holes of the book. Rotate the coil guide on top of the coil. Pull the handle down gently at first making sure the coil is rotating into the book without missing holes in the sheets or covers. Continue until the coil is past the left side of the book by about one or two coils.

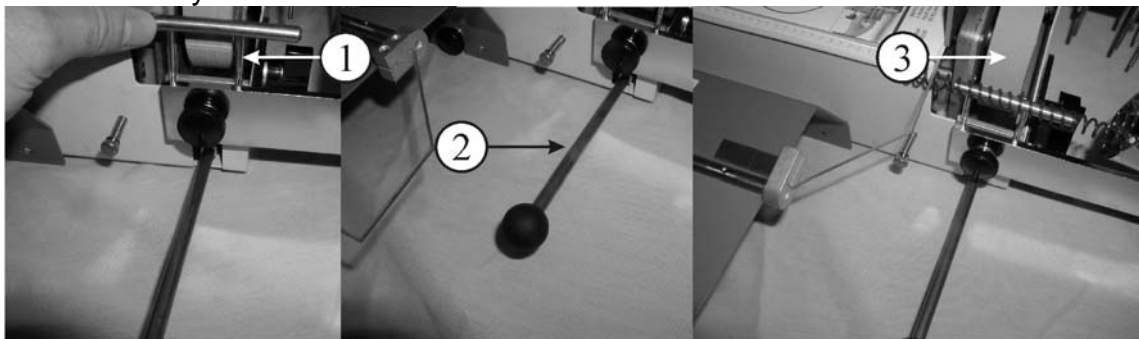

Diagram 7

10) Drive wheel stop screw. Diagram 8

The **drive wheel stop screw (1)** will prevent the wheel from pressing too hard on the mandrel. It is very important not to have too much pressure on the mandrel when inserting the larger coils. If the leading edge of the coil stops on a misaligned sheet, the coil wants to tie itself into a knot between the book and the end of the mandrel. Setting the stop screw will prevent this from happening most of the time. To set the stop screw, turn it clockwise to push the wheel away from the mandrel. Load the coil onto the mandrel and turn the stop screw counter clockwise while holding down on the motor handle until the drive wheel touches the coil. Try a few books and readjust if necessary.

If the coil chute / mandrel holder is moved after the stop screw has been adjusted, it will be necessary to readjust the stop screw.

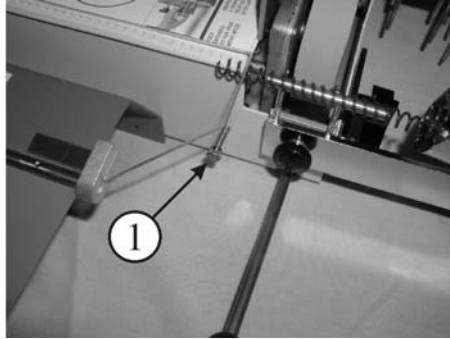

Diagram 8

11) Cutting a coil. Diagram 9 & 10 next page.

There is special cutter crimper pliers that are used to terminate the **ends of the coil (1)**. After the coil is cut, the sharp end of the coil will tuck itself under the inside of the coil opening. To use the cutter, make sure the **red dot (2)** is facing up. Place the cutter on the edge of the **right hand side of the book (3)**. Open the cutter enough so that the end of the cutter enters the coil by about a 1/4". **Make sure the cutter is level with and parallel to the book before you cut.** As you squeeze the cutter you may notice the coil wants to twist. You can support the coil with your fingers as you cut to help stabilize the coil. Turn the book over and repeat these steps on the opposite end of the book. Always make sure to close crimping cutters completely.

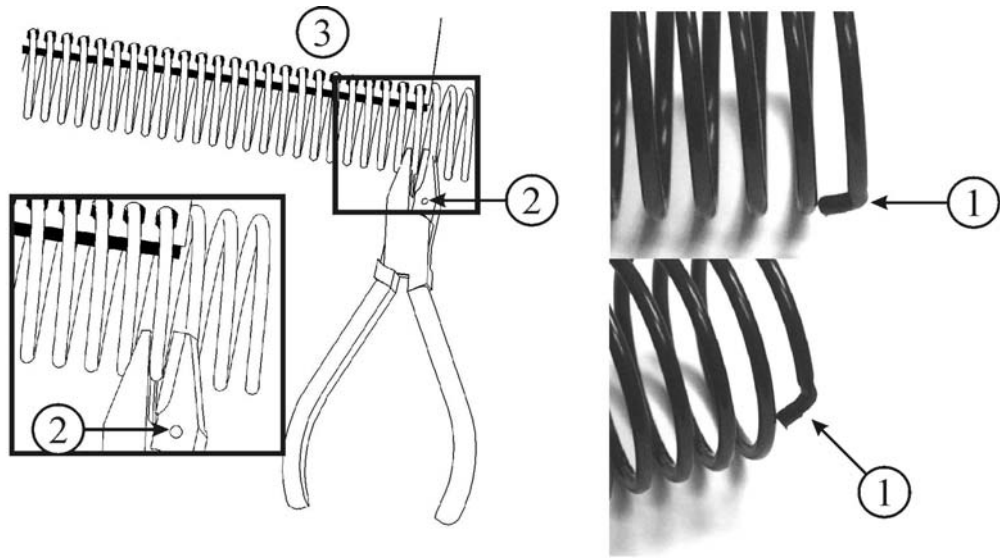

Diagram 9



Diagram 10

12) Pin Removal or Replacement and Waste Tray. Diagram 11

If you have a 115VAC machine a pin has been removed for you at the factory so that the correct number of holes will be in an 11" sheet. This pin is located on the top of the punch cover (1). To replace or remove a pin, pull the spare pin out of its holder (1). Then using a Philips screwdriver remove the 2 screws (2) that hold the punch cover on. Remove the punch cover. Using your fingers, pull (and push from behind) the four clevis pins (3) that hold down the punch pin backup bar. Pull the handle to its upward-most position (4) and pull up the backup bar (5). You can now pull out or replace pins. Reverse this process to reassemble your PC 2000. The Waste Tray (6) is located on the left side of the machine and should be emptied often during a large job.

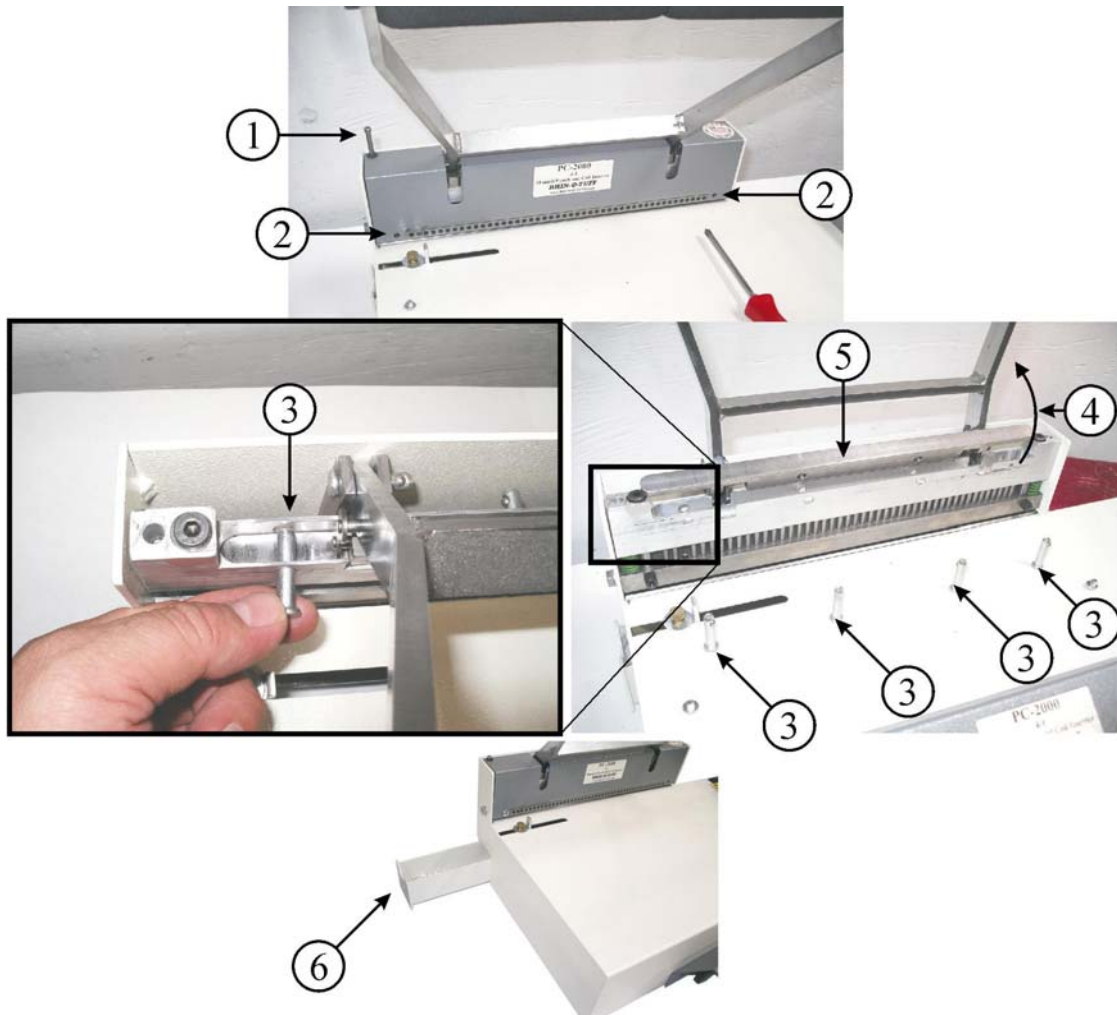

Diagram 11

13) Punching Paper. Diagram 12

To punch paper, first using one sheet, adjust the **paper stop (1)** to the correct position. Remove or add any required pin for your job as described in chapter 12. Then adjust the paper stop until the **sheet (2)** is punch symmetrically. To check for symmetry, fold the paper over on itself as shown. Align the top and bottom of the sheet then notice if the two last holes at each end of the page align. If they do not align, readjust the **paper stop (1)** until you have this aligned perfectly. Then punch your job with up to 12 sheets of 20 lb. or 80 gsm bond paper or the equivalent.

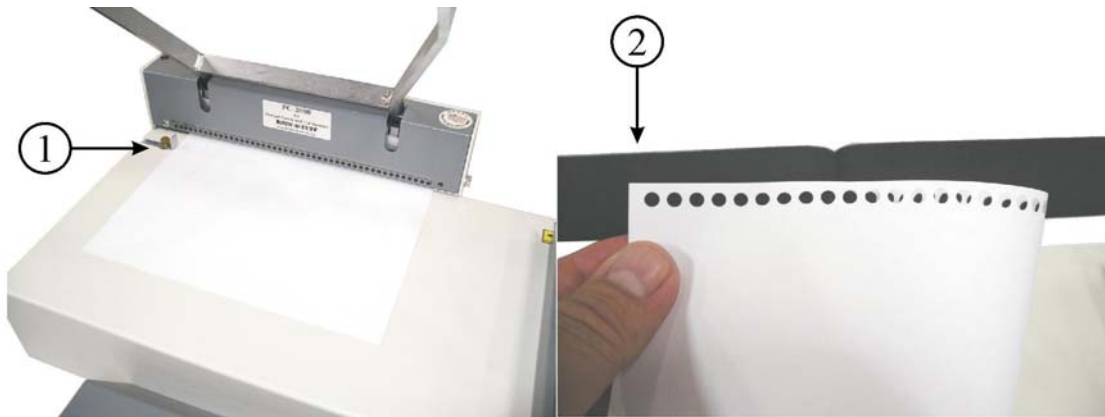
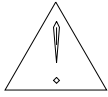

Diagram 12



Only qualified personnel should attempt to work on this equipment.

Most of the problems you may encounter are due to setup errors. There is one fuse located at the rear of the PC 2000 inserter that can be replaced by the customer. Below is a troubleshooting guide to help you through most of the problems that may be encountered.

Troubleshooting

Symptom	Possible Cause	Action
Drive wheel does not rotate. (There is a thermal overload built inside of the motor. Wait several minutes before checking the fuse)	<ol style="list-style-type: none"> 1) Machine is off. (Switch is in center position) 2) Machine not plugged in. 3) Blown Fuse. 4) Handle not depressed. 	<ol style="list-style-type: none"> 1) Place switch in either Forward or Reverse position. 2) Check both ends of power cord. 3) Check Fuse 1.
Coil tightens on the mandrel when inserting.	<ol style="list-style-type: none"> 1) Mandrel is too large for coil. 	<ol style="list-style-type: none"> 1) Select proper size mandrel. (See page 3)
Coil stops before it is completely through the book.	<ol style="list-style-type: none"> 1) The holes in the book are misaligned. 2) The coil is beyond drive wheel. 	<ol style="list-style-type: none"> 1) This is normal. Try moving the book around so the coil rotates in the holes. 2) Coil length may need to be longer for that particular book. Note: Larger coils can wind themselves open so the length is actually less.

PC 2000 Electrical Schematic NOTE: The motor is protected by a thermal overload located in the motor. It will reset automatically after the motor cools. 115VAC uses a 5 amp AGC fuse and a 5mf Capacitor. The 230VAC Model uses a 1 amp GDC Slow fuse and a 4mf Capacitor.

(115 and 230 volt AC)

