

Royal Sovereign RSH 1151 / 1651 Laminators

Instruction Manual



Provided by

MyBinding.com
When Image Matters.

Call Us at 1-800-944-4573

18. WARRANTY

Royal Sovereign International warrants the equipment sold is free from defects in material and workmanship for a period of One (1) year for Parts and Labor from the date of installation, excluding lamination rollers which are warranted for Six (6) months. This warranty is extended only to the original purchaser. This warranty is the only warranty made by Royal Sovereign International and cannot be modified or amended. Royal Sovereign's sole and exclusive liability and the customer's sole and exclusive remedy under this warranty shall be, at Royal Sovereign's option, to repair or replace any such defective part or product. These remedies are only available if Royal Sovereign's examination of the product discloses to Royal Sovereign's satisfaction that such defects actually exist and were not caused by misuse, neglect, attempt to repair, unauthorized alternation or modification, incorrect line voltage, fire, accident, flood or other hazard.

The warranty made herein is in lieu of all other warranties, expressed or implied, including any warranty or merchantability or fitness for a particular purpose. Royal Sovereign will not be liable for personal damage or personal injury (unless primarily caused by its negligence), loss of profit, or other incidental or consequential damages arising out of the use or inability to use this equipment.

LIMITED WARRANTY

This warranty specifically does not cover damage to laminating rollers caused by knives, razor blades, or any sharp objects or abrasives, or failure caused by adhesives, or damage caused by lifting, tilting and/or any attempt to position the machine other than rolling on the installed castors or feet on even surfaces, or improper use of the machine. Warranty repair or replacement by Royal Sovereign or its authorized Reseller(s) does not extend the warranty beyond the initial one year period from the date of installation. Unauthorized customer alterations will void this warranty.

CORPORATE HEADQUARTERS

Royal Sovereign International Inc.

2 Volvo Drive, Rockleigh, NJ 07647 U.S.A.

TEL : +1) 800-397-1025 FAX : +1) 201-750-1022

E-mail : info@royalsovereign.com

RS Holland B.V.

Columbusstraat 25 - 3165 AC Rotterdam,
The Netherlands

E-mail : paulchoi@royalsovereign.com

henyabrahamian@royalsovereign.com

Royal Sovereign Inc. <Oversea Sales Office>

1001, World Meridian II, 426-5, Gasan-dong,

Geumcheon-gu, Seoul, 153-759, KOREA

TEL : +82)2-2025-8800 FAX : +82)2-2025-8830

E-mail : sales@royalsovereign.com

RS Canada Inc.

164 Oakdale Road, Toronto, Ontario M3N 2S5
CANADA

TEL : +1) 416-741-8400 FAX : +1) 416-741-8185

E-mail : info@royalsovereign.com

RS International Australia PTY. LTD.

30 Prime Drive, Seven Hills, NSW 2147, Australia

TEL : +61) 2-9674-2127

FAX : +61) 2-9674-2027

E-mail : salesaust@royalsovereign.com

OWNER'S MANUAL

RSH-1151/1651 Laminator



Read all instructions carefully before use.

For any Customer Support needs please choose the
Customer Support tab on www.royalsovereign.com

Royal Sovereign International Inc.

www.royalsovereign.com

TABLE OF CONTENTS

TOPIC	PAGE
1. Introduction.....	2
2. Safety Precautions.....	2
3. Installation.....	3
4. Included with Laminator.....	4
5. Product Identification.....	5
6. Control Panel.....	6
7. Speed and Temperature Settings.....	8
8. Roller Nip Settings.....	8
9. Using Foot Pedal and Remote Control.....	9
10. Using Cross Cutter.....	9
11. Using Slitter.....	10
12. Loading Film.....	11
13. Threading Film	
13.1. Laminating and Encapsulation.....	12
13.2. Decaling.....	14
13.3. Mounting.....	15
14. Installation of the Front Feed and Rear Rewind Options.....	16
15. Maintenance.....	17
16. Troubleshooting.....	17
17. Specifications.....	18
18. Warranty.....	19

1. INTRODUCTION

Thank you for choosing a Royal Sovereign laminator. It has been designed and manufactured to provide years of continuous service. For complete operating and maintenance information please read this manual thoroughly. Upon receipt of your laminator, please inspect the box, the machine and all other contents for shipping damage. Damage should be brought to the immediate attention of the delivering carrier (See page 4 for list of shipment elements).

2. SAFETY PRECAUTIONS

Failure to comply with any of the following safety procedures could result in serious injury. Please read the instructions carefully and keep for future reference.

1. Only a licensed electrician should install wiring and outlet for the laminator.
2. Ensure the unit is plugged into a properly grounded outlet with the correct voltage.
3. Keep hands and clothing (i.e. Neckties) away from rollers. The rollers have pinch points that can trap body parts or clothing and cause serious injury.
4. Keep flammable and wet objects away from the machine.
5. Place machine on a level surface.
6. Avoid excessive sunlight, humidity and extreme temperatures.
7. Ensure the unit is turned off, cooled, and unplugged from the outlet prior to moving and/or repairing.
8. Keep out of reach of children.
9. Only Royal Sovereign authorized maintenance and service technicians should make repairs.
10. Do not attempt to laminate items that exceed total recommended material thickness for the unit
11. When cleaning the machine, don't use flammable sprays or materials.
12. Do not touch the rollers when they are hot or place foreign objects inside the machine.
13. Do not cover the surface of the machine until the machine has completely cooled.

3. INSTALLATION

Note: The laminator should be installed by a trained service technician.

The laminator comes fully assembled, except for the feed table and paper guide to avoid shipping damage. Upon arrival, thoroughly inspect the unit. It is imperative that any shipping damage is reported and a claim is filed with the delivering carrier immediately upon receipt.

The laminator should be located in an area with adequate work space for feeding graphics and lamination materials.

Avoid placing the laminator in a dusty area or near sources of extreme heat or cold.

Once the laminator is in place, lock the casters into position("ON" position). Always unlock the casters ("OFF" position) when moving to a different location.

ELECTRICAL REQUIREMENTS

Royal Sovereign recommends that a licensed electrician ensures proper power to your laminator in accordance with electrical codes in your area.

The laminator should have a dedicated power line.

POWER SUPPLY

AC 220~240V, 50/60Hz, Single phase



230V UL



220V EU



240V UK

4. INCLUDED WITH LAMINATOR

Thoroughly inspect the parts and the unit. It is imperative that any missing parts are reported and a claim is filed with the reseller immediately upon receipt of shipment.

Part Name	Quantity	Picture
Laminator	1	
Owner's Manual	1	
Registration Card	1	
3" (76mm) / 2" (57mm) Auto Grip	4/2	
L-wrench (2.5)	1	
Dust Cover	1	
Spare Motor Fuse - FUSE(50T) (6.3A)	1	
Spare Main Power Fuse - FUSE(65TS) 15A(RSH-1151) / 20A(RSH-1651)	1	
Roll film Samples	2	
8 - 1/4"Hexa head Bolt (M6 *20mm) 8 - Spring Washer(Ø6.1) (Included with option only)	8/8	
12 - 3/16" screw (M5 * 10mm). 12 - Spring Washer(Ø5.1) (Included with option only)	12/12	
Front Feeder and Rear Rewinder Kit (Included with option only)	2/2	

5. PRODUCT IDENTIFICATION

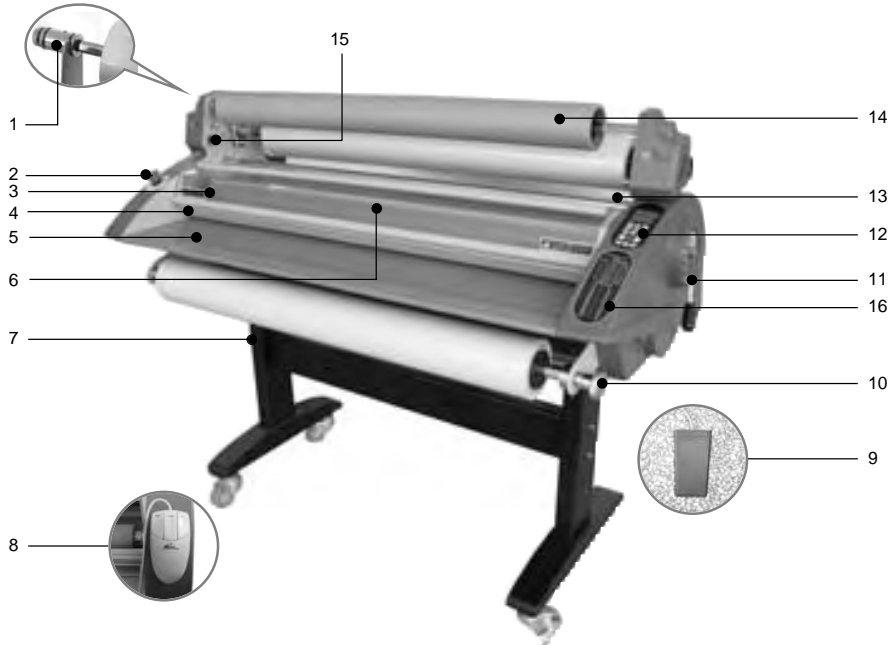

No.	PART NAME	RSH-1151	RSH-1651
1	FILM ALIGNMENT KNOB	OPTION	X
2	EMERGENCY SWITCH	0	0
3	SAFETY COVER	0	0
4	FRAME-PAPER GUIDE	0	0
5	FEED TABLE	0	0
6	HOT ROLLER	0	0
7	ASSEMBLY STAND	0	0
8	REMOTE CONTROL	0	0
9	FOOT PEDAL	0	0
10	TENSION CONTROL KNOBS	0	0
11	PRESSURE LEVER	0	0
12	CONTROL PANEL	0	0
13	UPPER IDLE BAR	0	0
14	RELEASE LINER TAKE UP	0	0
15	TAKE UP SWITCH	0	0
16	TEMPERATURE DISPLAY	° C & ° F	° C & ° F

6. CONTROL PANEL

When the machine is initially turned on, the LCD window will display the last working preset memory setting.

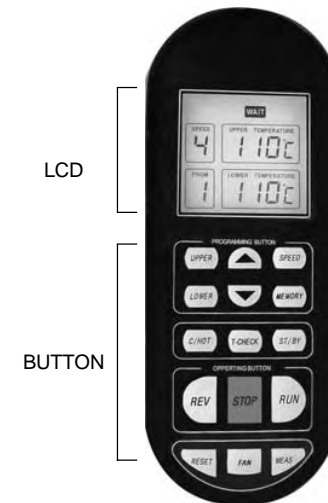

LCD Display

- READY** – When the preset temperature is reached.
- WAIT** – Blinks until preset temperature is reached.
- STND-BY** – When STND-BY button is manually pressed or if the machine has been standing idle for 2 hours . In this mode , the temperature will automatically reset to 176°F (80°C).After another hour,Power will automatically shut off .
- UPPER TEMPERATURE** – Displays upper roller set temperature.
- LOWER TEMPERATURE** – Displays lower roller set temperature.
- SPEED** – Displays set speed.
- PRGM** – Displays set memory.

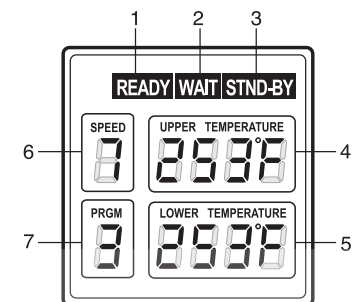

Control Buttons

1. **UPPER:** To change upper roller temperature by pressing button, then up or down arrow. (range 32~320°F or 0~160°C)
2. **LOWER:** To change lower roller temperature by pressing button, then up or down arrow. (range 32~320°F or 0~160°C)
3. **SPEED:** To change speed of the rollers by pressing button, then up or down arrow. (range 1 through 9)
4. **MEMORY:** To recall or change presets. To recall the settings, press MEMORY then up or down arrow. To save the settings, set desired temperatures and speeds then press the MEMORY button twice. (stores up to 9 different settings)
5. **C/HOT:** To change the mode from hot to cold or cold to hot lamination. In cold mode, the speed defaults to 2 (speed 1~ 9 settings) and stand-by function is disabled.
6. **T-CHECK:** To check current upper and lower roller temperatures. Display automatically returns to the previous settings after 5 blinks.
7. **ST/BY:** To change to stand-by mode (temperature will automatically reset to 176°F (80°C). While in this mode, all the buttons on the control panel are disabled. Press ST/BY mode button to resume normal operation.

NOTE: Auto stand by mode and auto power off mode

-Stand by mode: If no activity is made within 2 hours after each use the machine will automatically switch into stand by mode.

-Auto power off mode: If the machine is in stand by mode and no activity is made for 60 minutes the machine will automatically power off.

-If any activity is made while in stand by or auto power off mode the machine will return to it's previous stage.
8. **REV:** To reverse the rollers. Must press and hold the button to activate.
9. **STOP:** To stop the rollers from turning.
10. **RUN:** To start the rollers .
11. **RESET :** To reset the substrate and length counters (option). Press and hold RESET button for 2 seconds.
12. **FAN:** To activate the cooling fans.
13. **MEAS:** To display the substrate and length counters (option). Press button again to return to previous screen.

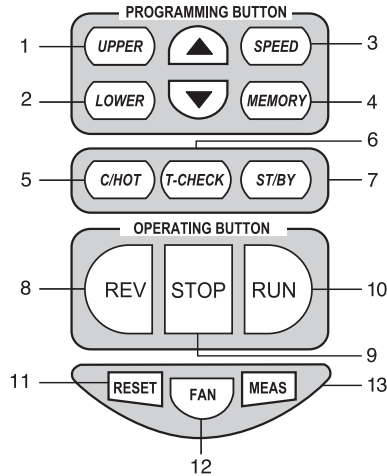

7. SPEED AND TEMPERATURE SETTINGS

SPEED #	Speed (Ft/min, M/min)	
	HOT	COLD
1	1.3 (0.4)	1.5 (0.5)
2	2.1 (0.7)	2.8 (0.8)
3	3.0 (0.9)	4.3 (1.3)
4	3.6 (1.1)	5.4 (1.7)
5	4.3 (1.3)	6.9 (2.1)
6	5.4 (1.7)	7.6 (2.3)
7	6.6 (2.0)	9.5 (2.9)
8	8.2 (2.5)	10.5 (3.2)
9	9.8 (3.0)	13.1 (4.0)

8. ROLLER NIP SETTING

No.	Inches	Metric (mm)
1	Lamination	Lamination
2	1/25"	1
3	3/16 ~1/4"	5-7
4	3/8 ~1/2"	10-13
5	3/5"	15

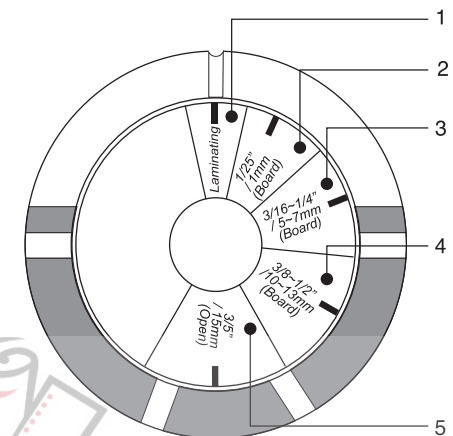

NOTE: If you don't want to laminate, please place the pressure lever to the "Open position(NO.5)".

9. USING FOOT PEDAL AND REMOTE CONTROL

USING FOOT PEDAL

Place the foot pedal on the floor in front of the machine. Once all correct settings are displayed, you may use the foot pedal to operate the laminator for "Hands Free Operation." To activate the machine, press the foot pedal once and then release. Repeat to stop the rollers.



USING REMOTE CONTROL(OPTION)

Located on the left hand side of the rear of the laminator, to use press:

1. **RUN** : To activate the rollers.
2. **STOP** : To stop the rollers from turning.
3. **REV** : To reverse the rollers. Press and hold the button (useful for jams or mis-feeds of media).

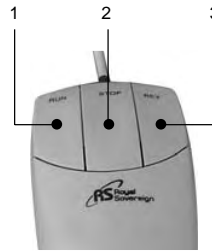

10. USING CROSS CUTTER

The cross cutter is located in the rear exit table of the unit.

1. After lamination, move the cutter approximately to the center of the completed application at the desired point of detachment (Figure 1).

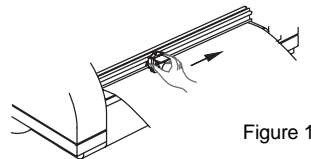

2. Grasp film with one hand, press the cutter downward into the application and slide it first to one end of the application, then to the other end to complete the cut (Figure 2 & 3).

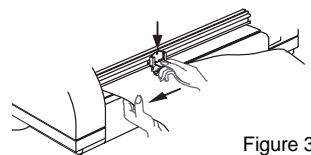
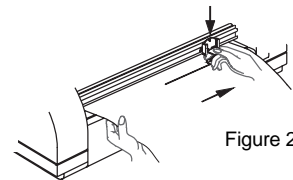

11. USING SLITTER (OPTION)

1. Adjust the left and/or right slitters by loosening the slitter adjuster knob (located between the front and rear rollers.) Figure 1

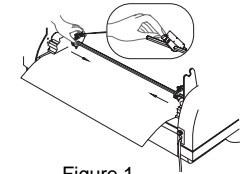

2. Activate the slitter by turning the slitter knob (located on the left side of the machine) counterclockwise. Figure 2



3. Once you activate the slitter then you can begin lamination. Figure 3

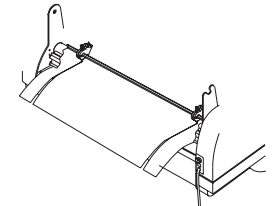

4. To deactivate the slitter turn the slitter knob clockwise. Figure 4

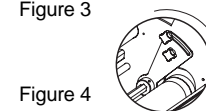

NOTE: When the slitter becomes dull break off the blade. Pull the lock back, then pull the slitter out, and push the lock back to previous position. Figure 5

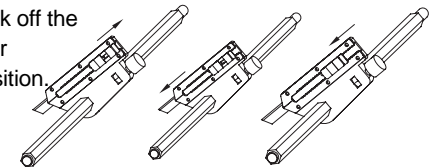

CAUTION

When the slitters are not in use please keep the slitters positioned at the far left and right side to avoid injury.

12. LOADING FILM

Royal Sovereign films are wound with the adhesive side facing the inside of the roll (adhesive in).

Loading films to upper and lower film shafts:
(See page 5 for assistance with parts identification.)

1. Adjust the auto grip to fit to the film and tighten the auto grip screw (Figure 1 & 2).



Figure 1



Figure 2

2. Remove the upper and lower film shafts from the machine and load the films (Center the upper and lower films on the shaft). Note the direction of the adhesives on the lower and upper films (Figure 3 & 4).

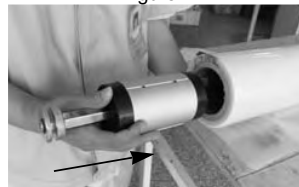

Figure 3



Figure 4

3. Load the upper and lower film shafts on the machine (Figure 5 & 6).



Figure 5



Figure 6

13. THREADING FILM

13.1 Lamination and Encapsulation

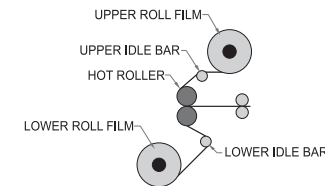

Thermal Lamination

1. Turn the power switch on ("I" position). Power switch is located in the rear of the unit on the left side.
2. Complete the steps on "Loading films to upper and lower film shafts" - Page 11
3. Set the rollers temperature to the recommended film temperature.
4. Take off the Paper Guide and the Front Table.
5. Pull down the upper film over the Safety Cover to the lower film; align and center the lower film to upper film (Figure 1).
6. Rewind the upper film back until the film aligns with the Safety Cover.
7. Thread the film over the Upper Idle Bar and underneath the Safety Cover until the film rests on the upper roller (Figure 2).
8. Carefully pull up the laminate from the lower roll around the back side of the lower idler (Caution: lower roller may be hot).
9. Tack the lower film to the upper film that is resting on the main roller (Figure 3).

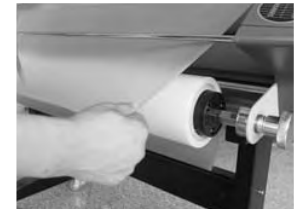

Figure 1



Figure 2



Figure 3

10. Reinstall the Front Table and the Paper Guide, and close the Safety Cover.

11. Adjust the nip setting to 1/8" (3mm).

12. Insert and push the leader boards on each end until boards reach the front nip point.

13. Push the Run button.

14. Push the leader boards between the pair of main rollers (Figure 4).



Figure 4

15. Press the Run button and adjust the supply roll tension knobs by rotating clockwise or counterclockwise. Turn it until the supply roll films have some resistance (the tension varies depending on the film thickness; the thicker the film the more tension is required) (Figure 5).



Figure 5

16. Press Stop button when the leader board has completely exited the rear of the unit.

17. Use the Cross Cutter to cut the leader board from the web (see page 9).

18. Peel off the film from the board for reuse.

19. Set the roller nip setting to the appropriate position for the lamination or encapsulation application.

13.2 Decaling

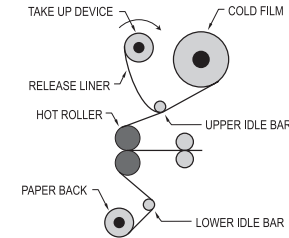

1. Follow the steps in the "Loading Film" procedure by loading the upper shaft with pressure sensitive film, e.g. (Royal Print-Pro Film) and lower shaft with pressure sensitive mounting adhesive films, e.g. (Royal Sovereign White-Mount or Clear-Mount).
2. Pull the upper laminate under the upper idle bar and separate the release liner from the laminate.
3. Tape the release liner to the Take-Up Paper Core and allow the laminate to hang over the main rollers.
4. Pull up the mounting adhesive and tack it to the laminate hanging over the rollers (do not use the Lower Idle Bar).
5. Reinstall the Front Table and the Paper Guide and close the Safety Cover.

6. Turn on the take-up switch (Figure 1).



Figure 1

7. Adjust the nip setting to 1/8" (3mm).
8. Insert and push the leader board until board reaches the nip point.
9. Press the Run button and adjust the supply roll tension knobs by rotating clockwise or counterclockwise. Turn it until the supply roll films have some resistance (the tension varies depending on the thickness of a film; the thicker the film the more tension is required).
10. Press Stop button when the leader board has completely exited the rear of the unit.
11. Use the Cross Cutter to cut the leader board from the web (see page 11).
12. Set the roller nip setting to the appropriate position for the lamination application.

13.3 Mounting

1. Lay the decaled image face down on a flat surface. Carefully peel back and put a crease along the edge of the release liner (Approximately 1 in or 25mm, Figure 1).



Figure 1

2. With the image facing up, align the image onto the board. Press firmly from the center out (Figure 2).



Figure 2

3. Adjust the pressure lever to ensure the proper opening (Figure 3).



Figure 3

4. Flip the image over the upper roller and hold on to the release liner (Figure 4).



Figure 4

5. Depress the foot pedal once, and then let it go while slowly pulling the release liner as the board enters the main roller nip (Figure 5).



Figure 5

Depress the foot pedal once again when the board has completely exited from the rear of the unit. Trim the board if necessary.

14. INSTALLATION OF FRONT FEEDER and REAR REWINDER OPTIONS

Note : Below options are to be installed by an authorized RS reseller.

Installation of the Front Feeder Option (Includes 2 brackets, one spindle, and mounting hardware).

1. Install the Front Feeder to the inside of the front frames using four 1/4" (M6) hexagon bolts on each side (Figure 1)



Figure 1

Installing the Rear Rewinder Option (Includes motorized winder, bracket, one spindle, and mounting hardware).

1. Remove the left and right covers by using a screwdriver (four screws on each side cover) (Figure 2 & 3).



Figure 2 Figure 3

2. Remove the lever knob screw and lever (Figure 4).



Figure 4

3. Remove the rear cover by removing all 10 screws (4 top, 4 bottom, and 1 on each side) (Figure 5 & 6).



Figure 5



Figure 6

4. Disassemble the power switch bracket and place the left rewinder outside of the frame; fasten with round head 3/16"(M5) screws (included in the option kit). Then, reinstall the power switch bracket (Figure 7).



Figure 7

5. Install the right rewinder on the outside of the frame and connect the motor wire connector to the rear wire (Figure 8 & 9).



Figure 8



Figure 9

6. Reinstall the rear cover.
7. Reinstall the side covers.
8. Reinstall the lever knob and screw.

15. MAINTENANCE

Cleaning the Body of the laminaor

- To clean the machine body, dampen a cloth with water only and gently wipe the machine clean.

Removing Adhesive Build Up

- Remove the film from the laminator.
- Use a damp (water only) cloth and a rubber gum eraser to remove the adhesive on the silicone rollers.

Note: Rub firmly but do not scrub the rollers vigorously as this may scratch the surface. Do not use sharp metal objects, steel wool, or abrasives, as these may also damage the rollers.

16. TROUBLESHOOTING

Problem	Cause	Solution
Machine will not turn on:	<ol style="list-style-type: none"> Power plug is not plugged in. Power switch is in "0" (Off) position. Tripped circuit breaker. Blown main power fuse. 	<ol style="list-style-type: none"> Plug the power cord into appropriate outlet. Put the power switch to the "I" (On) position. Reset the circuit breaker. Replace the fuse.
There is power, but the rollers are not turning after the "RUN" button is pressed:	<ol style="list-style-type: none"> Emergency switch (es) is (are) engaged. Safety cover is not closed. Paper guide is not installed correctly. Blown motor fuse. 	<ol style="list-style-type: none"> Disengage the emergency switch (es). Close the safety cover to activate the safety switch. Properly install the paper guide so that the micro switch is activated. Replace the motor fuse.
The unit is not heating up:	<ol style="list-style-type: none"> The machine is in "COLD" mode. Set temperature is lower than the room temperature. 	<ol style="list-style-type: none"> Switch to "HOT" mode. Raise the temperature according to the recommended film temperature.
Curled lamination:	<ol style="list-style-type: none"> Upward curl. Downward curl. 	<ol style="list-style-type: none"> Loosen the top roll film tension. Loosen the bottom roll film tension.
Unclear lamination:	<ol style="list-style-type: none"> The main roller temperatures are too low and/or lamination speed is too fast. 	<ol style="list-style-type: none"> Raise the roller temperatures and/or lower the lamination speed.

17. SPECIFICATIONS

Description	RSH-1151	RSH-1651
Power supply	AC 200,220~240V 50/60Hz	AC 200,220~240V 50/60Hz
Power consumption	3300W	3300W
Max laminating width	1150mm / 45"	1650mm / 65"
Film thickness	25 ~ 250mic / 1~10mil	25 ~ 250mic / 1~10mil
Max laminating speed	Hot : 3 m/min / 9.8 ft/min Cold : 4 m/min / 13.1 ft/min	Hot : 3 m/min / 9.8 ft/min Cold : 4 m/min / 13.1 ft/min
Ready time	20 min	40 min
Heating method	Hot roller	Hot roller
Driving motor	DC geared	DC geared
Max. temperature control	160°C / 320°F	160°C / 320°F
Speed control	9 settings	9 settings
Transport type	4 Roller	4 Roller
Film core size	Auto grip (2.25", 3")	Auto grip (2.25", 3")
Cooling system	2 Blower	3 Blower
Side cutter	No	No
Cross cutter	Yes	Yes
Film alignment	No	No
Hot lamination	Yes	Yes
Cold lamination	Yes	Yes
Mounting thickness	15mm / 0.6"	15mm / 0.6"
Take up system	chain link to main motor	chain link to main motor
Paper counter	Option	Option
Length measurement	Option	Option
Reverse	Yes	Yes
Remote control	Yes	Yes
Foot pedal	Yes	Yes
Unit dimensions (w x d x h)	1500 x 650 x 1210 (mm) 59" x 25.5" x 47.5"	1960 x 650 x 1210 (mm) 77" x 25.5" x 47.5"
Unit weight	169kg / 373lbs	269kg / 593lbs
Carton dimensions (w x d x h)	1660 x 900 x 1460 (mm) 65.5" x 35.5" x 57.5"	2190 x 900 x 1460 (mm) 86" x 35.5" x 57.5"
Carton weight	280kg / 618lbs	394kg / 869lbs