

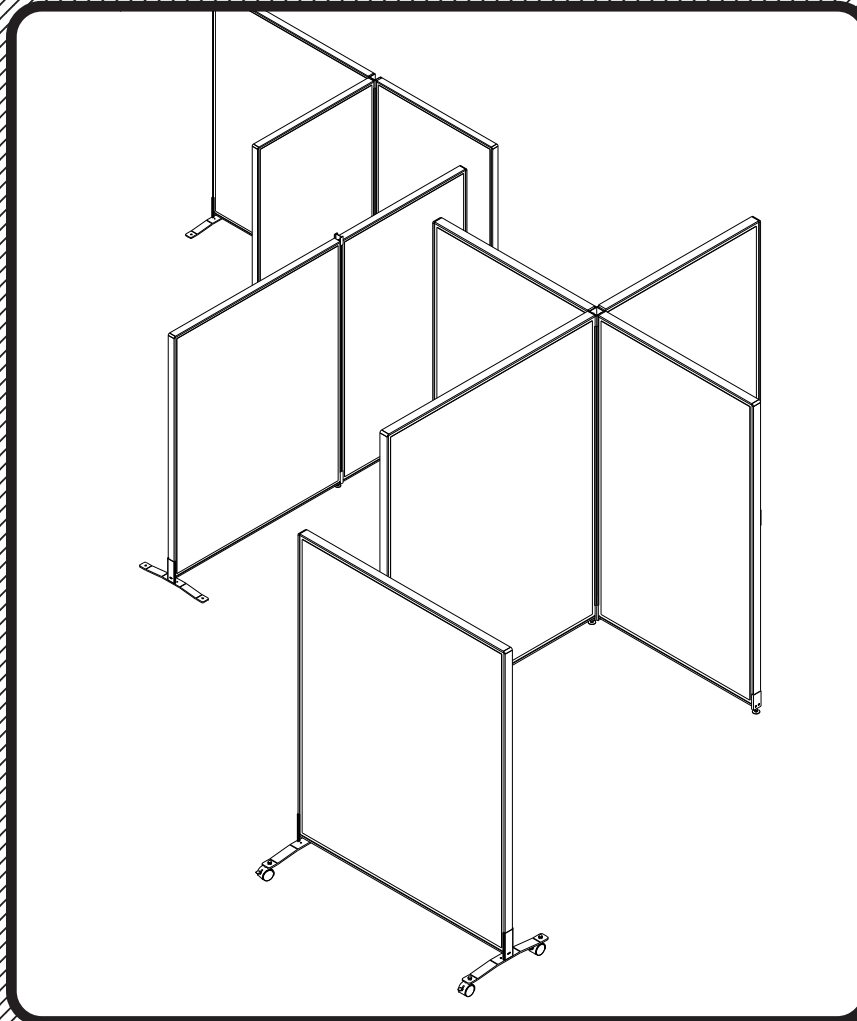

Best-Rite™

# Modular Room Divider



## Assembly Instructions

# Modular Room Divider

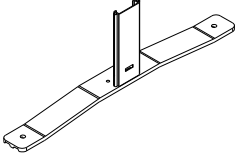
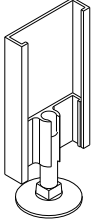
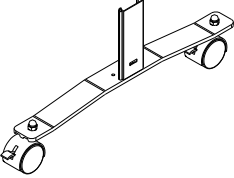
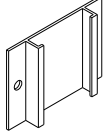
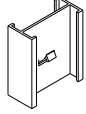
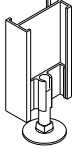
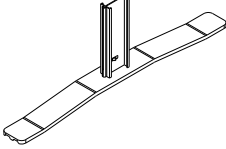
Part No.	Drawing	Description
66200		T-Base Foot-(Side)
66201		Single End w/Adjustable Leg
66204		T-Base Foot w/Casters
66205		Wall Connector
66206		2 Way Straight connector (top)
66207		2 Way Straight connector w/ Adjustable Leg
66208		T-Base Foot (Center)

**Should you require assistance during assembly, please call our Customer Service Department  
Monday - Friday 8 a.m. - 5 p.m. Central Standard Time  
Toll-Free Customer Service  
1-800-749-2258**

# Modular Room Divider

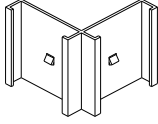
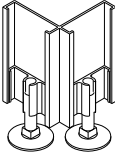
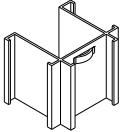
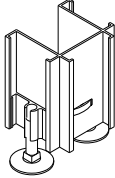
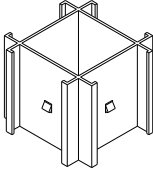
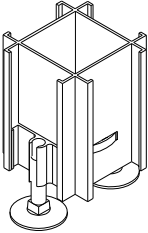
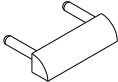
Part No.	Drawing	Description
66209		2-way Right angle Connector (Top)
66210		2-way Right angle Connector w/Adj Leg
66211		3 way Connector (Top)
66212		3 way Connector w/Adj Leg
66213		4 Way right angle Connector (Top)
66214		4 Way right angle Connector w/Adj Leg
		Plastic Corner for Modular Panel (Factory installed in Modular Panels)

**Missing Parts or UPS Damaged Parts**  
 For Your Convenience you can  
 EMAIL us at  
***support@moorecoinc.com***  
 24HOURS 7 DAYS A WEEK

# Freestanding Modular Panels

Illustration # 1

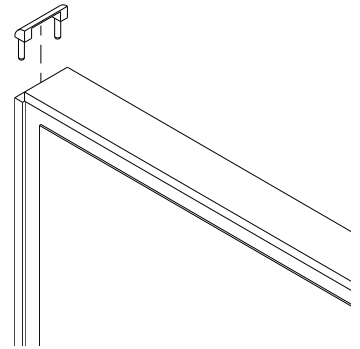

Replace Corner Cover.

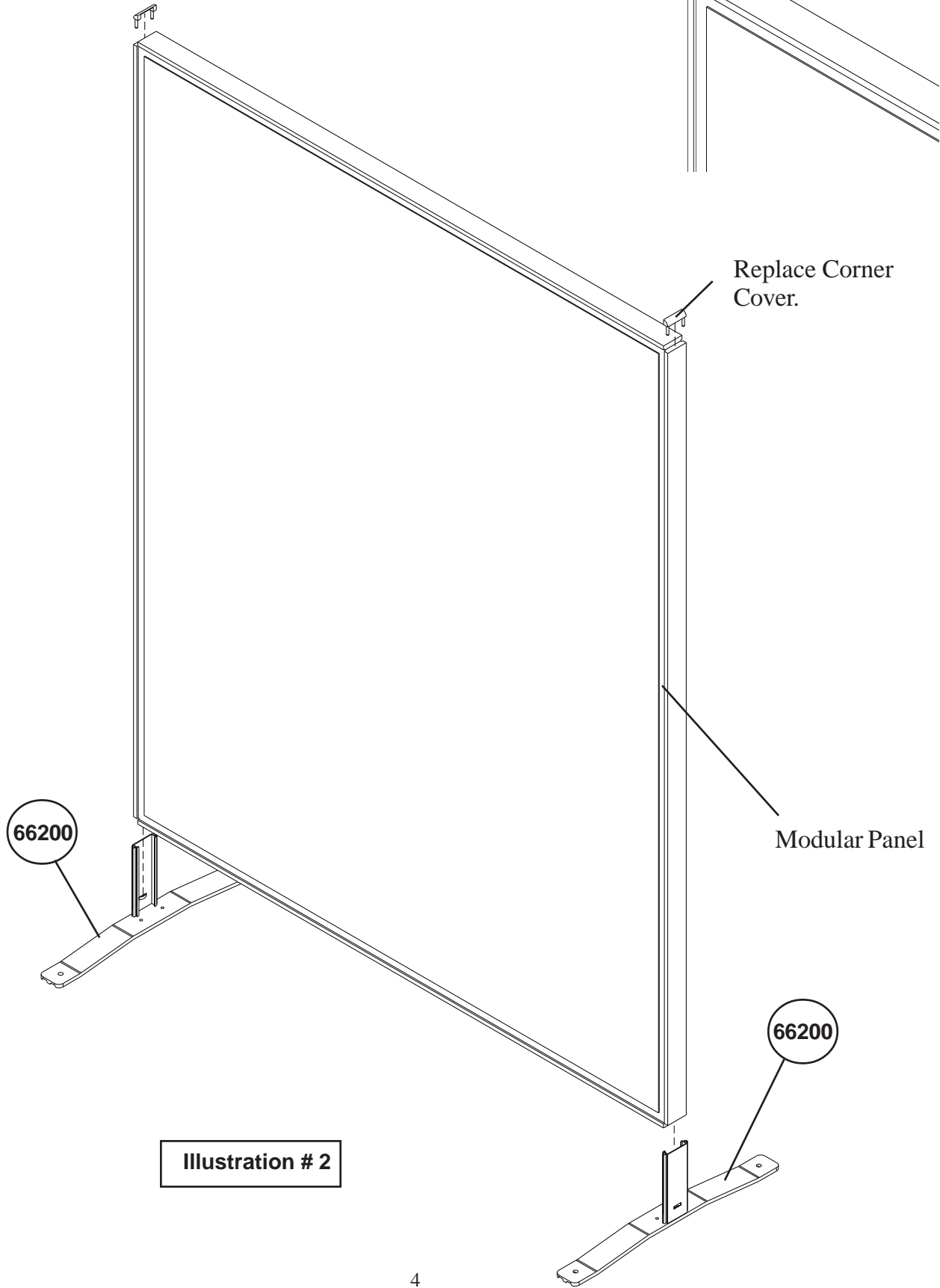
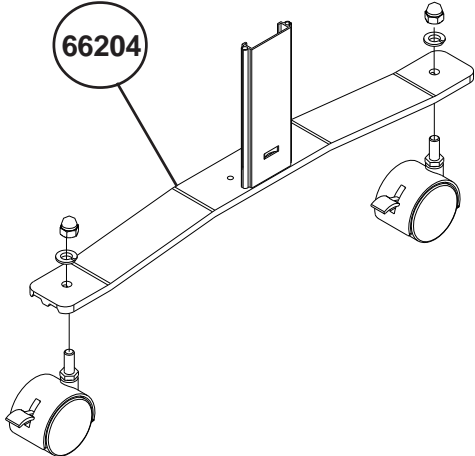

Illustration # 2

# Freestanding Panels w/Casters

Illustration # 1



Replace Corner Cover.

Illustration # 2

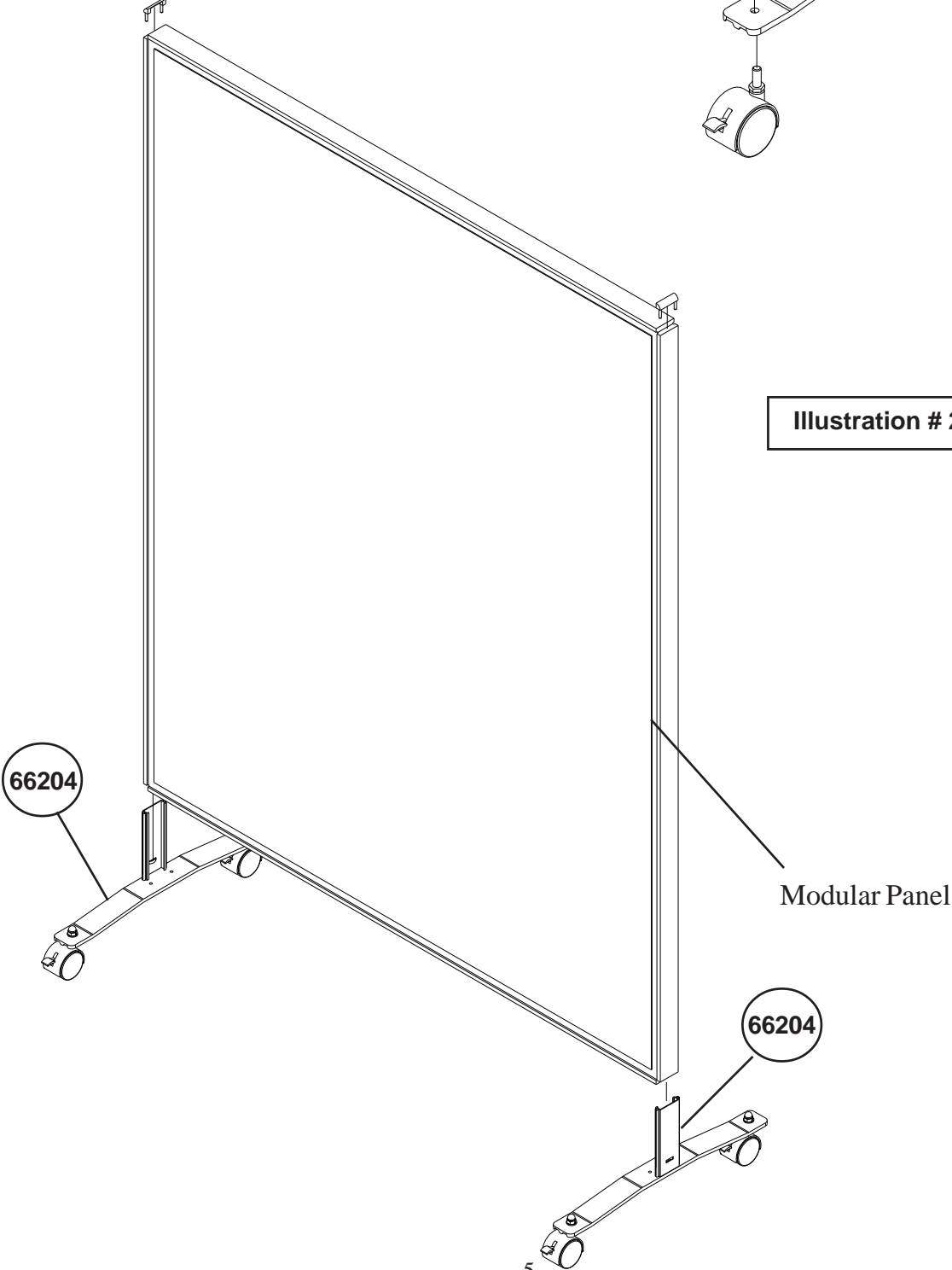

# Connecting Panels

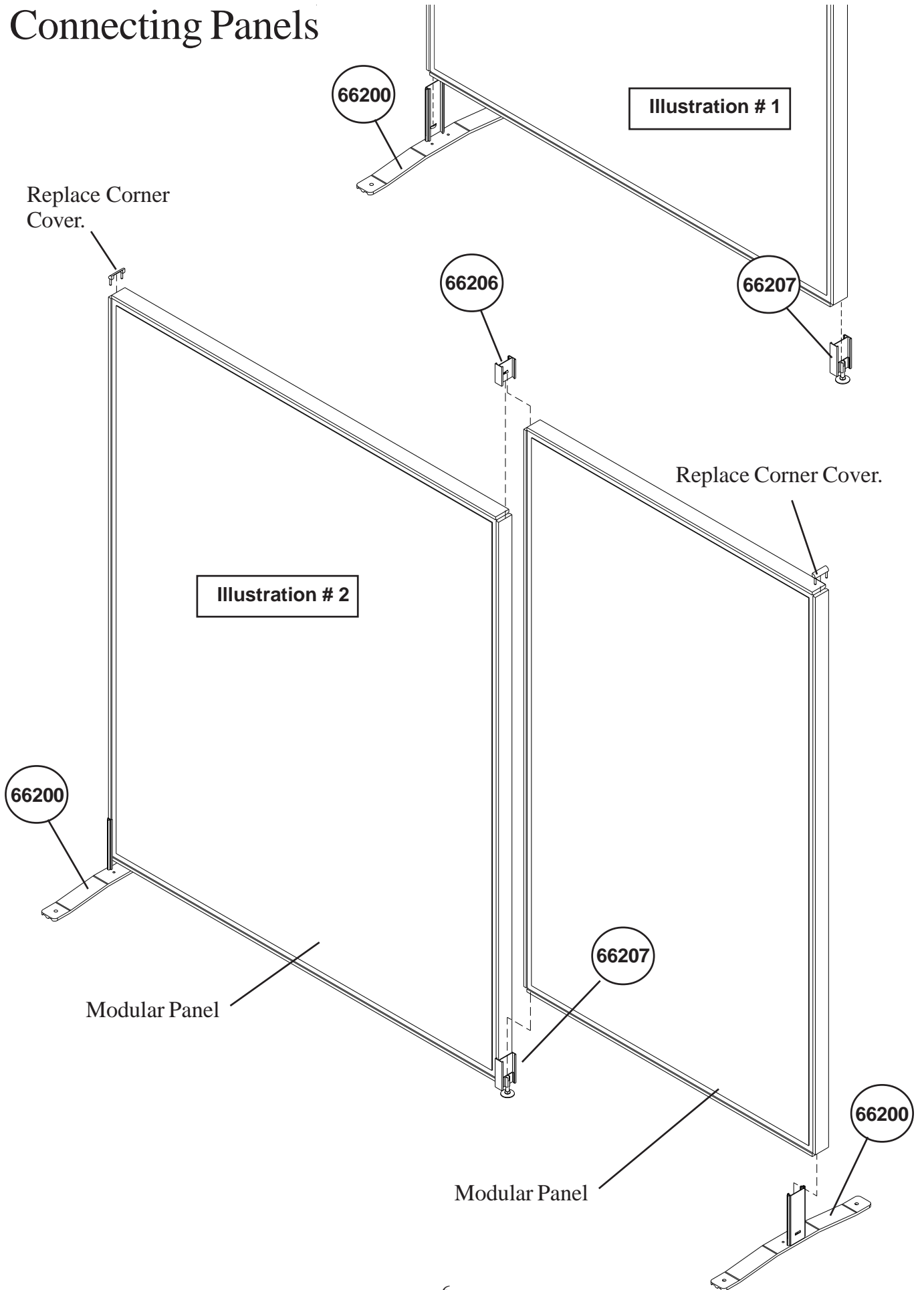

# Connecting Panels w/3 Way

Illustration # 1

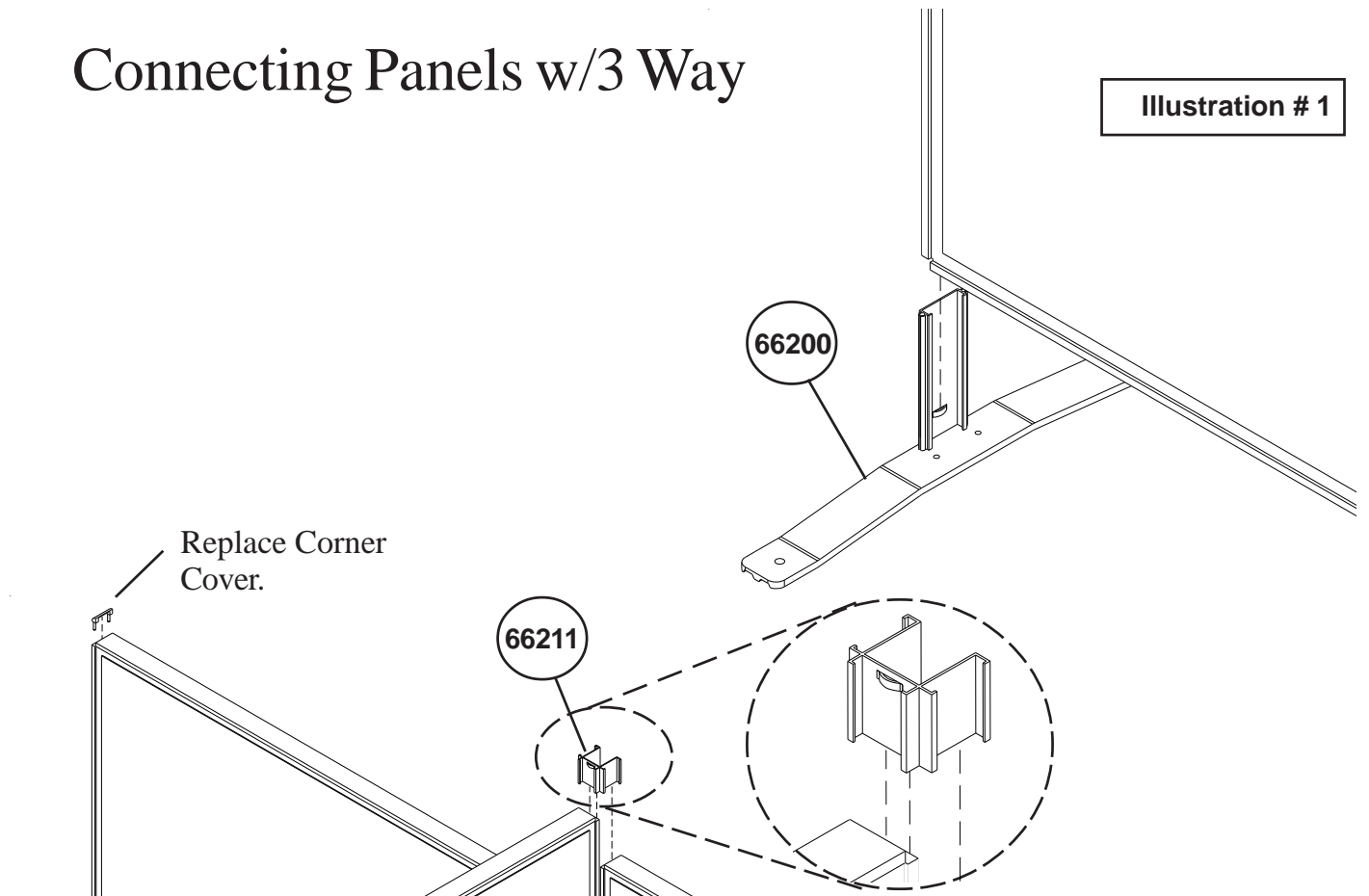
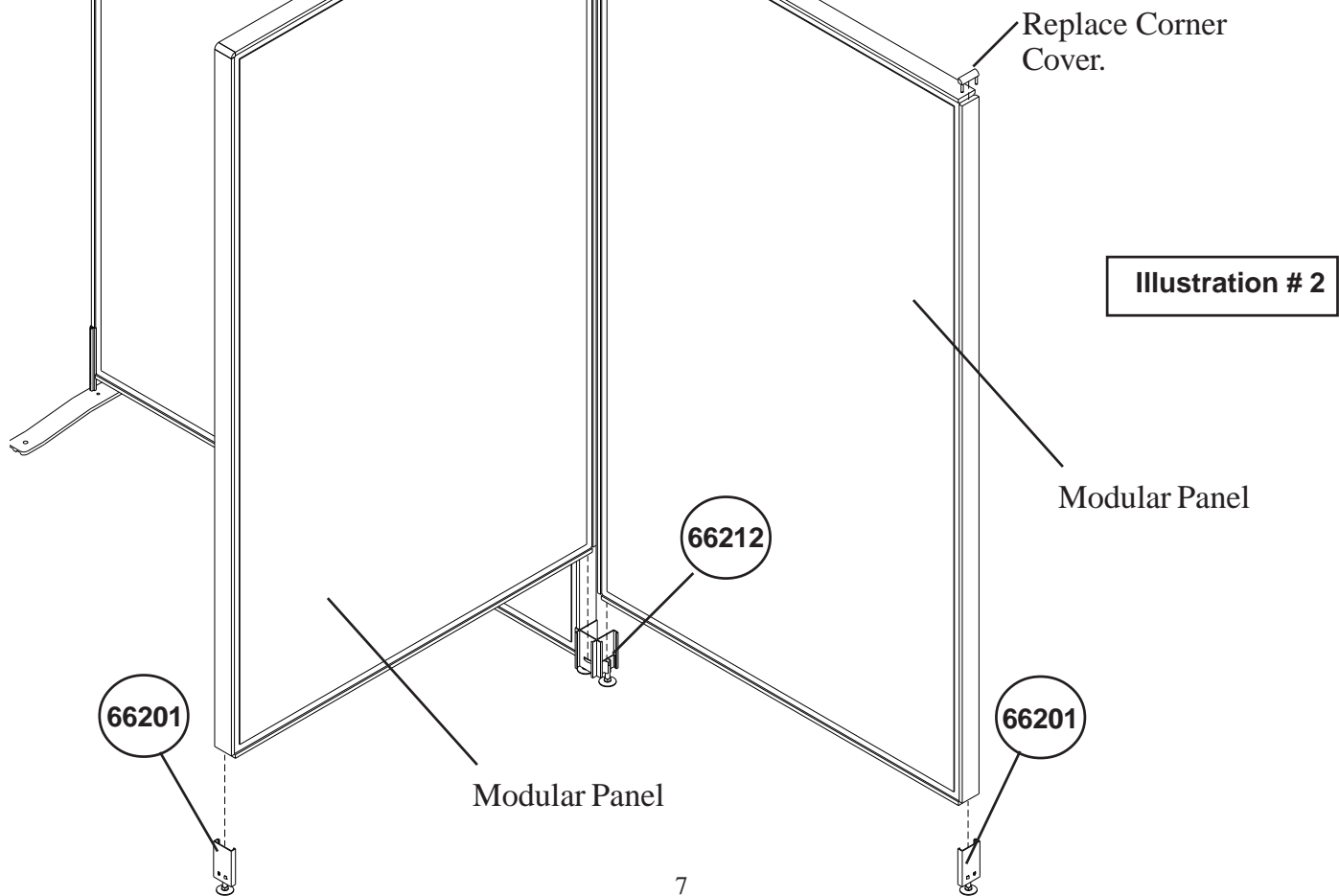

Illustration # 2



# Connecting Panels w/4 Way

Illustration # 1

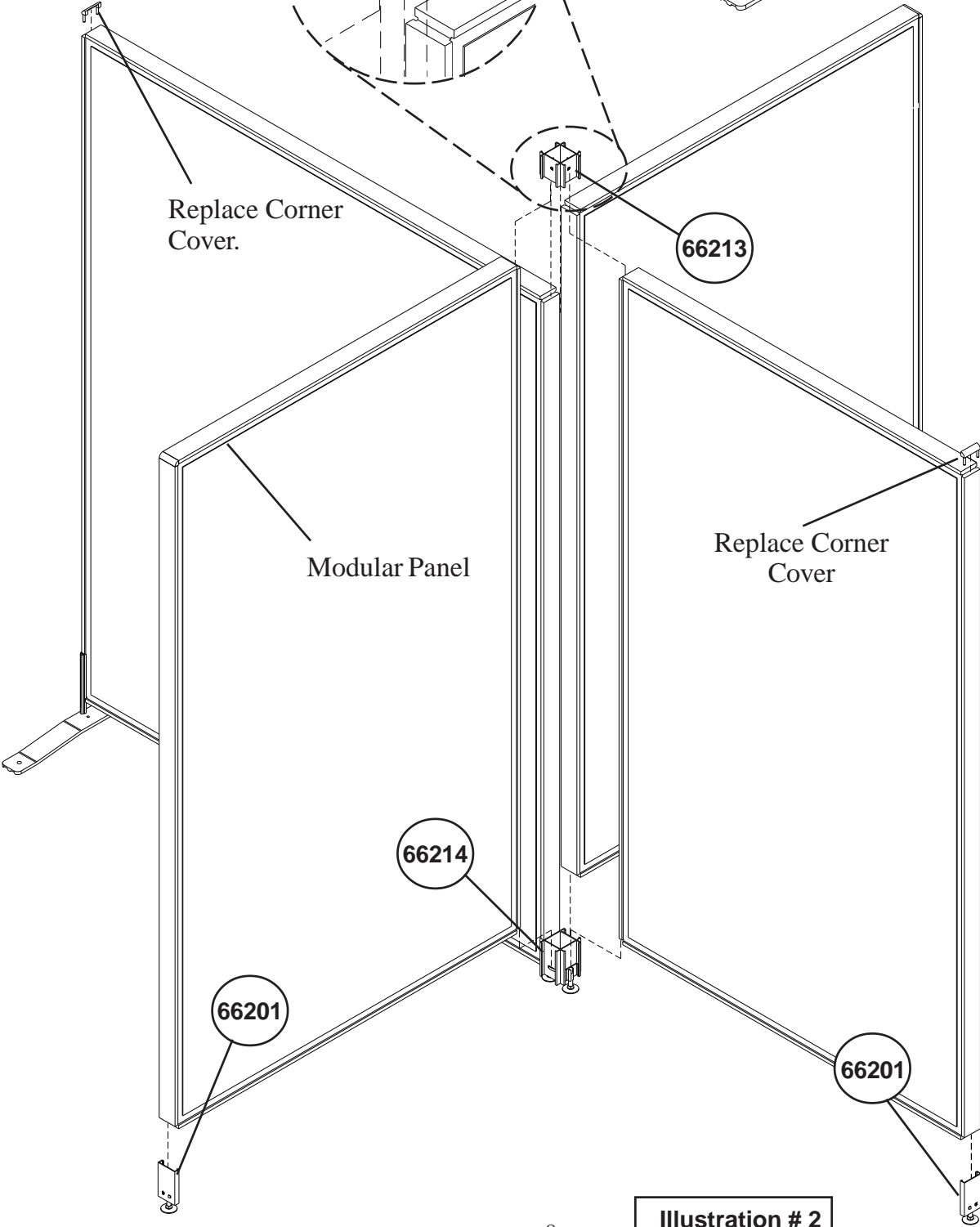
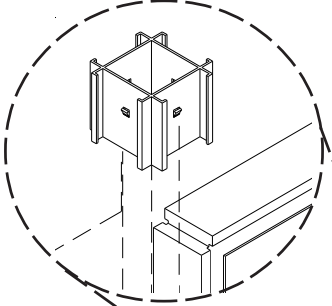
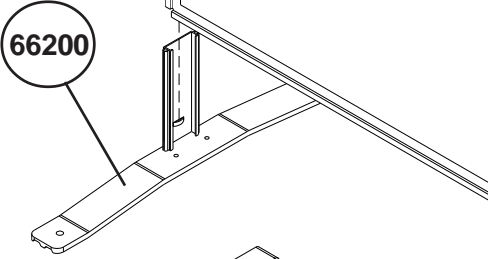

Illustration # 2



# Connecting Panels w/Wall Mount

Replace Corner Cover.

66205

Illustration # 1

Replace Corner Cover.

Modular Panel

66205

66201

